

Final Report Contract RS-050962-A02

Between

Thomas Dreschel, Ph.D., Project Manager
Everglades Division
South Florida Water Management District (SFWMD)
3301 Gun Club Road
West Palm Beach, FL 33406

And

Florida International University
Southeast Environmental Research Center
University Park Campus
Miami, FL 33199
Administrative Contact: Roberto Gutierrez, Director
Office of Sponsored Research Administration

**Loaxahatchee Impoundment Landscape Assessment (LILA):
Tree Island Experiments and Management
May 1, 2005 to September 4, 2009**

August 17, 2009

Leonard J. Scinto, René Price, and Mike Ross.
Southeast Environmental Research Center and Department of Earth and Environment
Florida International University, Miami, FL 33199
(305)-348-1965 (ph), (305)-348-4096 (fax) scintol@fiu.edu

Table of Contents

1. Executive Summary
2. Project Introduction
3. Task 1. Development of the Project Work Plan
4. Task 2. Site Management and Operations
5. Task 3. Topography and GIS Mapping
6. Task 4. Hydrology
7. Task 5. Vegetation Studies
8. Task 6. Soil/Sediment Transport, Accretion, Loss, and Tree Island Morphology
9. Task 7. Site Coordination and Public Outreach

This is the Southeast Environmental Research Center (SERC) of Florida International University (FIU) Contribution T447.

1. Executive Summary

This report is presented as the Final Project Report (Deliverable 7i) of the amended contract RS-050962-A02 and is meant to summarize all deliverables due between project initiation on May 1, 2005 and ending May 31st, 2009. The original contract with FIU was extended to cover the interim period between December 31st 2008 and the initiation of the next contract LILA Phase III. The Deliverables associated with this report and the final funds payment include this report (Task 7i), a description of on-site management and maintenance (Task 2i), the monitoring of water level for the period 04/01/09 and 05/31/09 (Task 4i) and the initial soil elevations at locations on all Tree Island SETs (Task 6g). Additionally, this Report serves as the Final Report, summarizing all work to date.

Table 1.1. Significant management dates during contract duration.

Date	Description
May 1, 2005	Project Initiation
June 6, 2005	Contract signed (Total Project Cost = \$450k)
June 20, 2005	Kick Off Meeting and acceptance of Final Work Plan
February 14, 2007	Contract Amendment A01 (Total Project Cost = \$505k)
November 26, 2008	Contract Amendment A02 (Total Project Cost = \$605k)
May 1, 2009	Contract Amendment A03 (no cost extension until Sept. 4, 2009)

2. Project Introduction

Hydrologic modifications have negatively impacted the Florida Everglades in numerous significant ways. The compartmentalization of the once continuously flowing system into the Water Conservation Areas (WCAs) caused disruption of the slow natural flow of water south from Lake Okeechobee through the Everglades to Florida Bay. The ponding of water in the WCAs, the linking of water flow to controlled water levels, and the management of water levels for anthropogenic vs. ecological well-being has caused a reduction in the spatial heterogeneity of the Everglades leading to greater uniformity in topography and vegetation. These effects are noticeable as the degradation in structure of the Everglades Ridge and Slough environment and associated Tree Islands. In aquatic systems water flow is of fundamental importance in shaping the structure and function of the ecosystem. The organized patterns of parallel orientation of ridges, sloughs, and tear-drop shaped tree islands along historic flow paths attest to the importance of water movement in structuring this system.

Our main objective was to operate and manage the LILA facility to provide a broad potential as a research platform for an integrated group of multidisciplinary, multi-agency scientists collaborating on multifunctional studies aimed primarily at determining the effects of CERP water management scenarios on the ecology of tree islands and ridge and slough habitats. We support Everglades water management, CERP, and the Long-Term Plan by defining hydrologic regimes that sustain healthy tree islands and ridge and slough ecosystems. Information gained through this project will help to reduce the uncertainty of predicting the tree island and ridge and slough ecosystem response to changes in hydrologic conditions. Additionally, we have developed the LILA site as a visual example of Everglades restoration programs in action.

3. Task 1. Development of the Project Work Plan

The first task associated with this project was the development of a detailed Project Work Plan (PWP), the presentation of which occurred during the Project Kickoff Meeting. Specific deliverables were attending the Kickoff meeting (Task 1a) and submitting the final PWP (Task 1b). The Project Kickoff meeting was held on June 20, 2005 at the West Palm Beach Offices of the SFWMD and was attended by all members of the FIU team: Mike Ross, Rene Price, Len Scinto, and Eric Cline. Each member of the FIU team made presentations pertaining to their lead areas of the Project Work Plan (PWP). **This PWP was accepted without major revision therefore satisfying the requirements of the Project Kickoff Meeting (Task 1a) and submission of Final Work Plan (Task 1b). Thus, Task 1 was completed.**

4. Task 2. Site Management and Operations

Our highest priority was to set a hydrologic regime for the fostering of tree island establishment. We have focused on the determination of site topography, water velocities and hydrological functions, and getting trees planted and established (see section 7). We set an operational hydrograph into operation (see section 6) and have maintained the LILA site hydrology, including operational flow characteristics resulting in flowing (M2 and M4) and non-flowing (M1 and M3) treatments. Maintaining the LILA site as a research and demonstration platform required repairs to levees and culverts, and of the equipment required to hydrologically operate LILA (pump switches, stage gauges, etc.) which often became large tasks in themselves. The establishing of vegetation on the tree islands involved vegetation control and providing irrigation. Accessibility to the site was maintained and functioned well, considering the numerous tours given of the facility. Although not in the original contract, the FIU Team extensively promoted LILA to other scientist and the public.

All deliverables associated with this task have been completed. Operations of the LILA facilities have continued through the contract period without any major, long-term interruptions. Continuous reporting of problems, development of solutions, and implementation of remedies has occurred. Routine operations have been summarized in each Annual Report.

Operational activities during the contract period were mostly conducted by Eric Cline and Ryan Desliu. The site manager, Eric Cline became a time-limited USPS employee of the State of Florida, Florida International University on August 8th 2005. Ryan Desliu was hired in April 2006 to assist Eric. Eric Cline became an employee of the SFWMD on August 22nd 2008 but remained the LILA Site Manager with Ryan Desliu (FIU) as the Assistant Site Manager.

Hydrologic operations of the LILA site vary from the routine opening of flow gates to vary the stage in the cells to the complex problems of diagnosing and repairing major problems with the pump, culverts and other water control structures. During the contract period, water levels were generally manipulated on two-week intervals according to the operational hydrograph (section 6). Major construction activities to allow better water delivery to and within the LILA site included the plugging, installation, and repair of the B culvert system and the addition of a culvert on the southern end of the header canal and the installation of an additional 36 inch culvert and riser in the LILA header canal. Maintaining relatively controlled flow conditions in LILA involved the calibration and use of many velocity measuring devices on a nearly continual basis. A significant event occurred when the LILA pump was removed and refurbished.

Vegetation issues were a regular and continuing concern at the LILA Site and ranged from planting and irrigating tree seedlings to insure their survival to applying herbicides and other control mechanisms to remove unwanted vegetation. In February 2006 (M1 and M4) and March 2007 (M2 and M3) 2848 trees of eight species were planted on the tree islands. To insure initial growth an irrigation system was built with routine watering being conducted when needed (Figs. 4.1 and 4.2). Other notable vegetation control measures included numerous bouts of herbicide applications, running a “cookie cutter” to keep channels open, and installing a vegetation rake on the pump inlet. Vegetation control included prescribed burns and herbicide application, both methods which required staff to undergo additional training.

The FIU LILA operational staff were largely responsible for maintaining the research infrastructure for a variety of agencies and organizations all working at the site. Staff helped establish, maintain and improve the LILA trailer as an office and research center equipped with areas for meetings and accommodations for overnight guests. Major repairs often followed storm events during hurricane seasons. Significant infrastructural improvements included the construction of sedimentation and erosion table (SETs), walkways in each of the four cells, and the installation of seven new stage gauges, installment of well points, creation of a plant materials laboratory and the installation of a LILA weather station. These improvements as well as many other made LILA a well-developed and useful research platform benefitting many scientists. Some of the research projects beside the FIU LILA projects to benefit from our activities include the Scot Hagerthey (SFWMD) and Partrac floc tracer study, the FAU wading bird prey enclosure experiment, the EPA Ridge And Slough Transplant (RAST) project, Colin Saunders' Cladium SET experiment, FAU and Mark Cook's crayfish mark and recapture study, SFWMD wading bird observations, and the UF and Mac Kobza exotic fish species studies to note of few.

LILA outreach has become a valuable activity, encouraging the dissemination of knowledge about Everglades restoration to other scientists and informed stakeholders, and to the public in general. Our contract staff have helped provide tours to a wide variety of visitors. Tours have been provided to the Missouri River Ecosystem Restoration Plan task force, the South Florida Ecosystem Restoration Task Force. They also conducted Princeton and Eckerd Universities tours. We have also provided golf-cart tours of the site at the annual Everglades Day Festival every year of this contract. In promoting LILA, staff presented numerous lectures and posters at several notable events, including the Greater Everglades Ecosystem Restoration meetings and at several Loxahatchee Science Meetings.

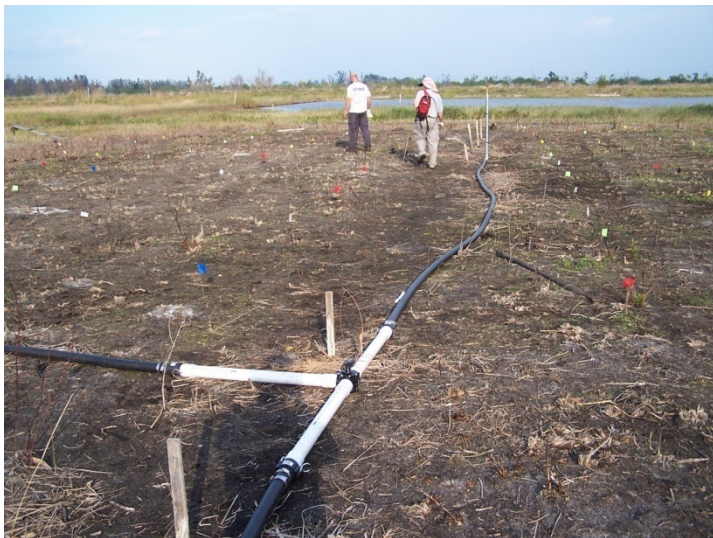



Figure 4.1 and 4.2. Irrigation system on one of the tree islands showing t-valve (top) that diverts water to each of the 2 standpipes and nozzles on each tree island (bottom) as required to partially satisfy Task 2a.

The above section attests to the construction of the irrigation system, the continual routine maintenance, site management, reporting, and research and educational assistance provided in the operation of the LILA site for the period from May 1, 2005 until March 31st, 2009 therefore satisfying the Deliverables under Task 2a - i of the contract.

5. Task 3. Topography and GIS Mapping

The water depth, velocity, and extent of inundation are all important factors involved in almost all aspects of this study. We have worked to develop a detailed, high resolution, topographic map as a Geographical Information System (GIS) overlay of each cell (Fig. 5.1). Combining this topography with the stage data allows an estimate of the water depth and period of inundation for any point in a cell at any time by knowing the stage (water level) at any nearby point (e.g., at one of several recording stage monitors). Completion of this task required the installation of benchmarks on tree islands, measuring detailed tree elevations on all eight islands, the establishment of elevation transects across the cells, manually incorporating data from the

original as-built plans, and the georeferencing of aerial photographs and other experimental instrument and sampling locations (e.g. SETs and wells, etc). A Dell Computers XPX system capable for GIS applications was purchased to assist in GIS work.

The objectives of Task 3a-d under this section were to develop high resolution maps as a GIS overlay of each cell from which estimates of water depth and period of inundation at any point could be determined. Elevations and possible changes in elevations over time would be determined by elevation measurements made by topographic surveying using a limited number of transects. We conducted topographic surveys on six transects in two of the cells (M1 and M4) early in the study (summarized in the second annual report) in conjunction with water velocity measurements. It became apparent after the initial velocity transect work that flow measurements along transects would not be adequate to characterize the complex flow patterns of the LILA cells. Therefore transect velocities were discontinued in lieu of dye studies and other hydrologic measures. We therefore had to adapt our project. We established new benchmarks on the centers of each tree island and measure detailed island topographies. In addition to early transect work we incorporated As-Built measures into a GIS overlay and again conducted transect elevations in 2008. We incorporated georectified aerial photography from 2000, 2003, 2004, 2006, 2007, and 2008 into a GIS data base. We also spatially located several research sites and experiments and have the ability to map these locations and link them to data in a database. This will allow current and future researchers to be aware of what activities are being performed at LILA and when specific work was conducted.

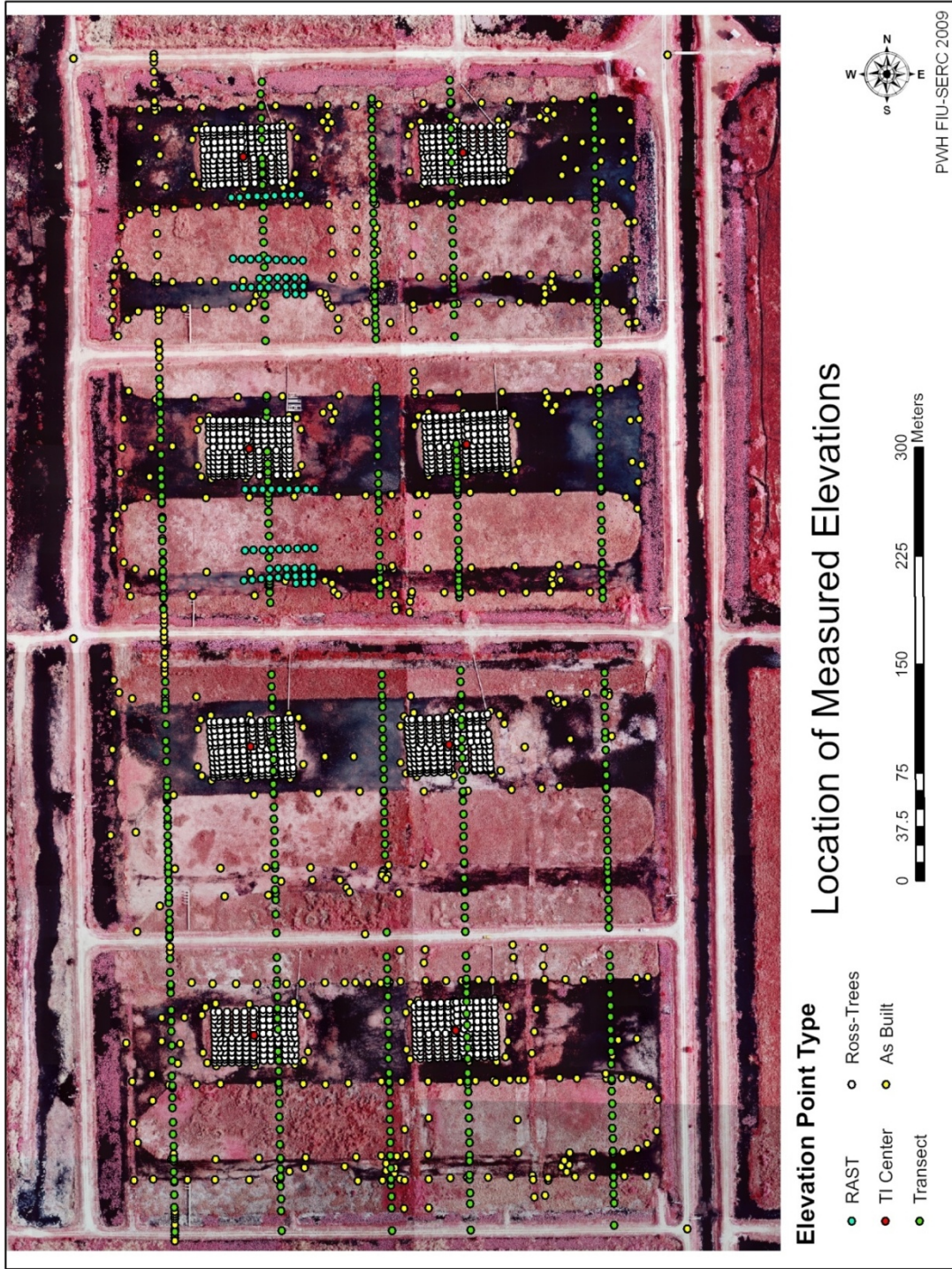

Figure 5.1. an aerial image showing all elevation data points of all cells. Composite of data collected until May 2009.

Additional benchmarks were established at the center of each tree island by driving a rebar rod into the soil. The elevation of these rods was determined using an Autolevel (Nikon, Japan) and a nearby permanent benchmark on September 16, 2005. A number of permanent benchmarks, already established on the levees were used as the reference points. During the course of survey from permanent benchmarks to the rebars on islands, temporary benchmarks were established along the way on the levee, and elevation differences between adjacent benchmarks were determined from at least two positions, such that the difference in two estimates was not more than 2 mm. On the way from the levees to islands, the rigid metal pipes supporting the board walks were used as temporary benchmarks. Finally, the elevations of the rebars and ground within 10 cm radius from them were determined and heights of rebars from the ground were also calculated. Table 5.1 illustrates the elevation of each rebar and ground at the center of each island.

Benchmark	Island ID	Rebar Elev. NGVD-29 (m)	Ground Elev. NGVD-29 (m)	Rebar height (m)	Rebar Elev. NGVD-29 (ft)	Ground Elev. NGVD-29 (ft)	Rebar height (inch)
BM-19.31	M1-E	5.152	5.075	0.077	16.902	16.649	3.031
BM-19.38	M1-W	5.093	5.037	0.056	16.709	16.526	2.205
BM18.54	M2-E	5.061	4.949	0.112	16.606	16.238	4.409
BM-20.09	M2-W	5.267	4.979	0.288	17.282	16.337	11.339
BM-18.65	M3-E	5.059	4.941	0.118	16.598	16.211	4.646
BM-20.10	M3-W	5.063	4.966	0.097	16.611	16.293	3.819
BM-18.69	M4-E	5.251	5.061	0.190	17.227	16.603	7.480
BM-18.69	M4-W	5.164	5.025	0.139	16.943	16.487	5.472

A detailed topography was developed for each LILA tree island. Once our tree island benchmarks were established (Table 5.1) they were used to produce increasingly detailed maps of tree island topography, which, in combination with stage data, will allow the description of the hydroperiod at any location on the islands. During the surveying of the M4W tree island, we evaluated two methods of topographic surveying. We compared a visual auto-level to a Laser level. The comparisons of resultant measures showed that both methods were highly comparable with variation between instruments of less than 5 mm. We therefore used the Laser Level (allows twice as many elevation measures to be made for same effort) to survey the other three islands and for most other elevation measures. Topographies of the tree islands are shown in SURFER plots in Figs. 5.2 through 5.5.

M1-W Elevation - NGVD 29

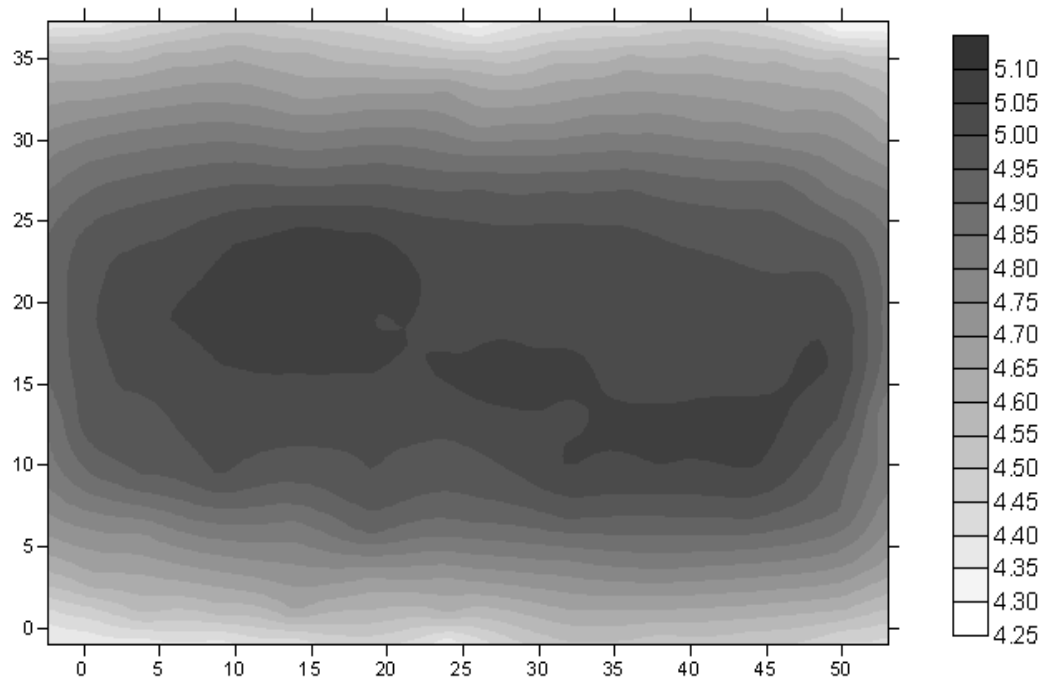

M1-E Elevation - NGVD 29

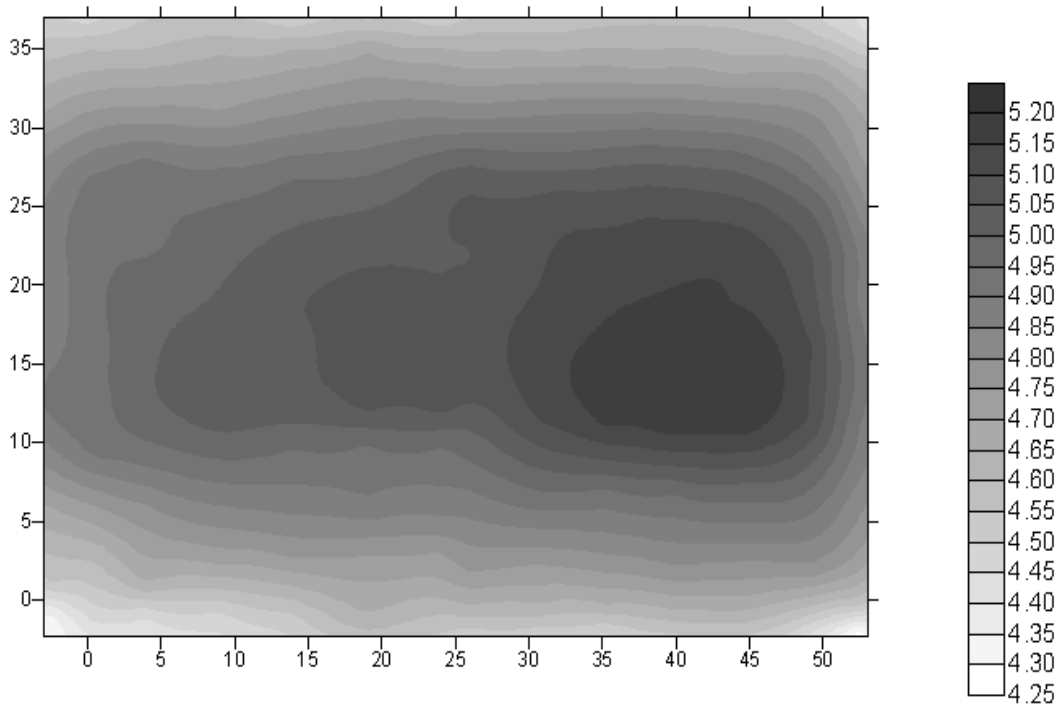

(A) Contour - 5 cm

Figure 5.2. Elevation isopleths for the M1 West and M1 East tree islands in meters.

M2-W Elevation (m)-NGVD 29

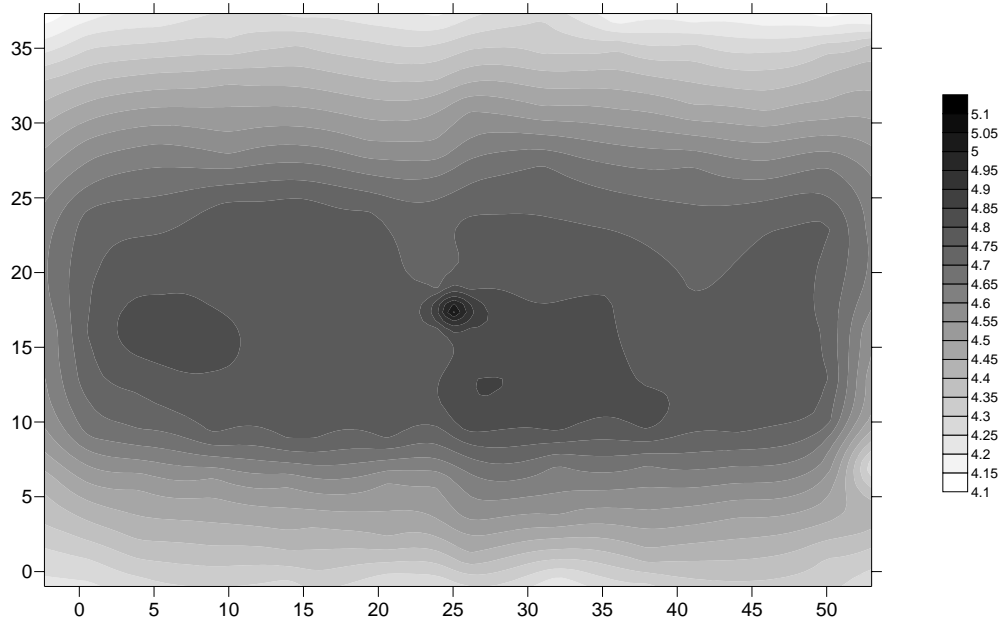

M2-E Elevation (m)-NGVD 29

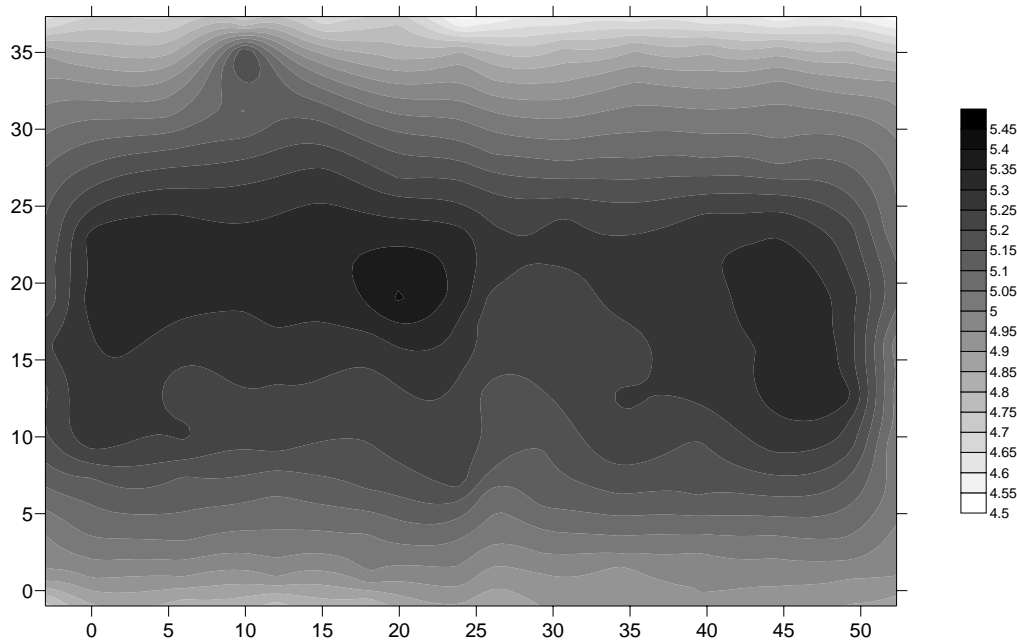
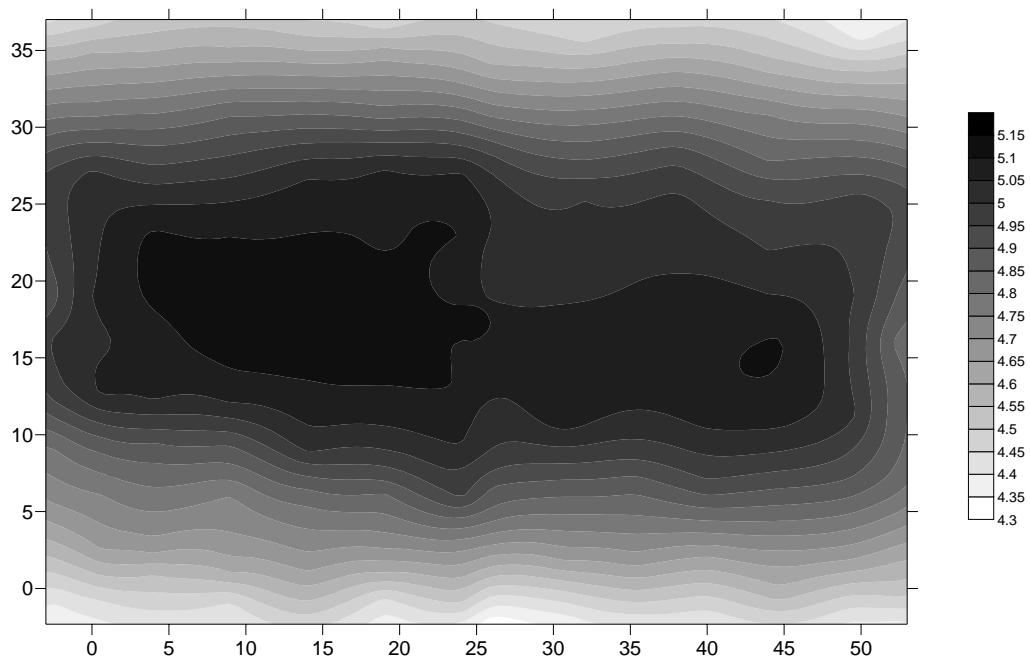

Figure 5.3. Elevation isopleths for the M2 West and M2 East tree islands in meters.

M3-W Elevation (m)-NGVD 29



M3-E Elevation (m)-NGVD 29

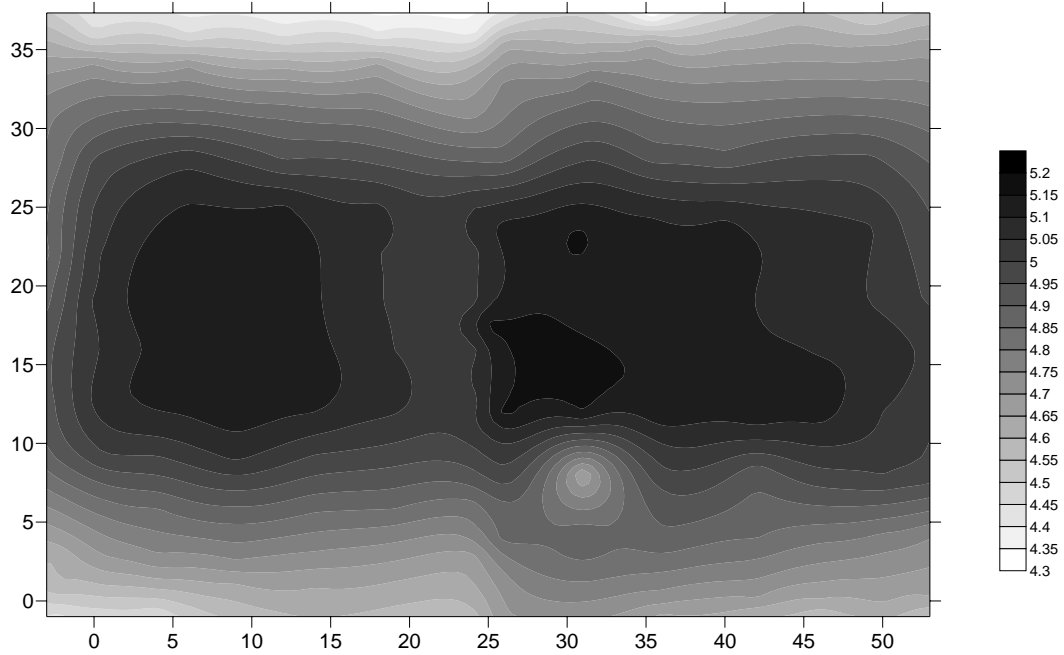

Figure 5.4. Elevation isopleths for the M3 West and M3 East tree islands in meters.

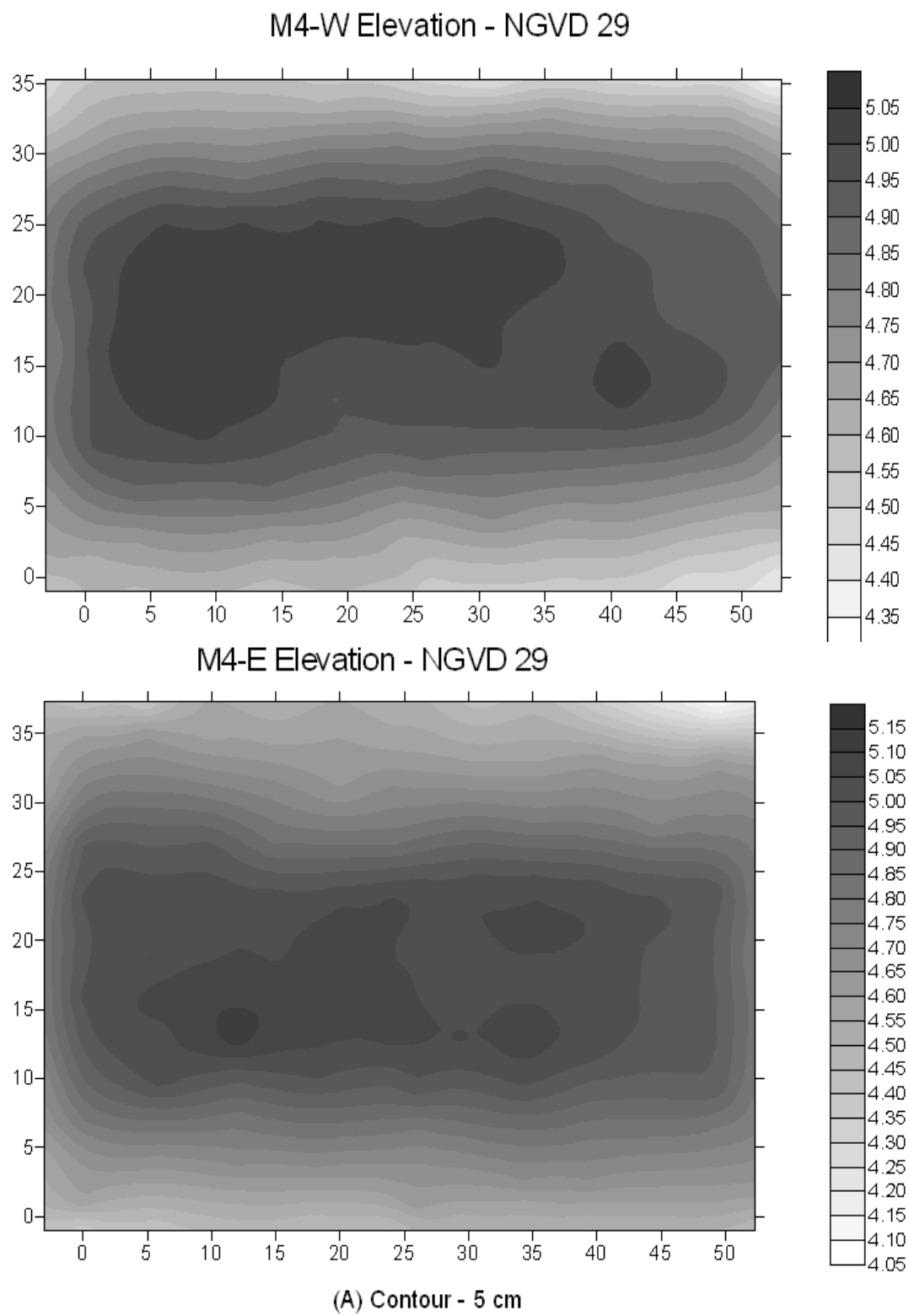

Figure 5.5. Elevation isopleths for the M4 West and M4 East tree islands in meters.

In June 2006, seven transects oriented north to south were established across each of the four mesocosms (Fig. 5.6). These transects were labeled A through G with A located at the west side of the mesocosm, and G located along the east side of the mesocosm. The transects were marked in the field with 0.5 inch PVC pipe driven into the ground at four locations along each transect. These transects were used to determine water depth, floc depth, and soil elevations, along with water velocity and discharge measurements (section 6, Hydrology). For the determination of each of these parameters, a measuring tape was attached to the PVC pipes and strung across the transects. Measurements were not made along transect A in each of the mesocosms because this transect is in the deep water of the header distribution channel. Measurements were thus made along all remaining 6 transects (B through G).

Elevations of water levels, floc thickness and top of soil as determined along the transects in mesocosms M1 and M4 were determined in July 2006. These data were contoured using SURFER to produce Figures 5.7 and 5.8. These 2006 elevation measures showed that water levels in M1 ranged from 15.46 ft (4.71 m) at the upstream (west) end of the mesocosm to 14.51 ft (4.42) at the downstream (east) end. Water levels in M4 were more variable across the mesocosm and ranged from 13.2 ft (4.02 m) to 15.96 ft (4.86 m). Floc thicknesses ranged from 0 to 46 cm in M1 with an average thickness of 11 cm. In M4, flock thickness ranges from 0 to 30 cm, with an average thickness of 14 cm. In M1, the elevation of the bottom of the deep slough ranged between 12.5 ft to 13.5 ft). Elevation of the bottom of the deep slough in M4 ranged between 12.5 and 14.0 ft.

These initial elevation measurements (July 2006) along transects were made in concert with water flux studies. Although useful information was obtained from these initial flux measurements it was decided that additional flow studies, possibly including dyes, would be conducted during the 2007 and 2008 wet seasons. We therefore did not continue these elevation measurements along transects in M2 and M3. To bolster early measurements of elevation we manually entered elevation data from the engineering drawings (As-Built) plans. The original principal scan was brought into the mapping system and georeferenced to line up with the original CAD data. The elevation points were then manually mapped into a GIS layer. Additionally, transect soil elevations were collected along five re-established transects, each in all four cells in June and July 2008. Similar procedures were followed, but rather than extending a measuring tape across the cells we placed markers at both sides (width) of each cell and measured the distance along transects by using a range finder (general accuracy < 1 m). Elevations were determined using the Laser Level as above.

Landscape Scale Transects (locations are approximate)

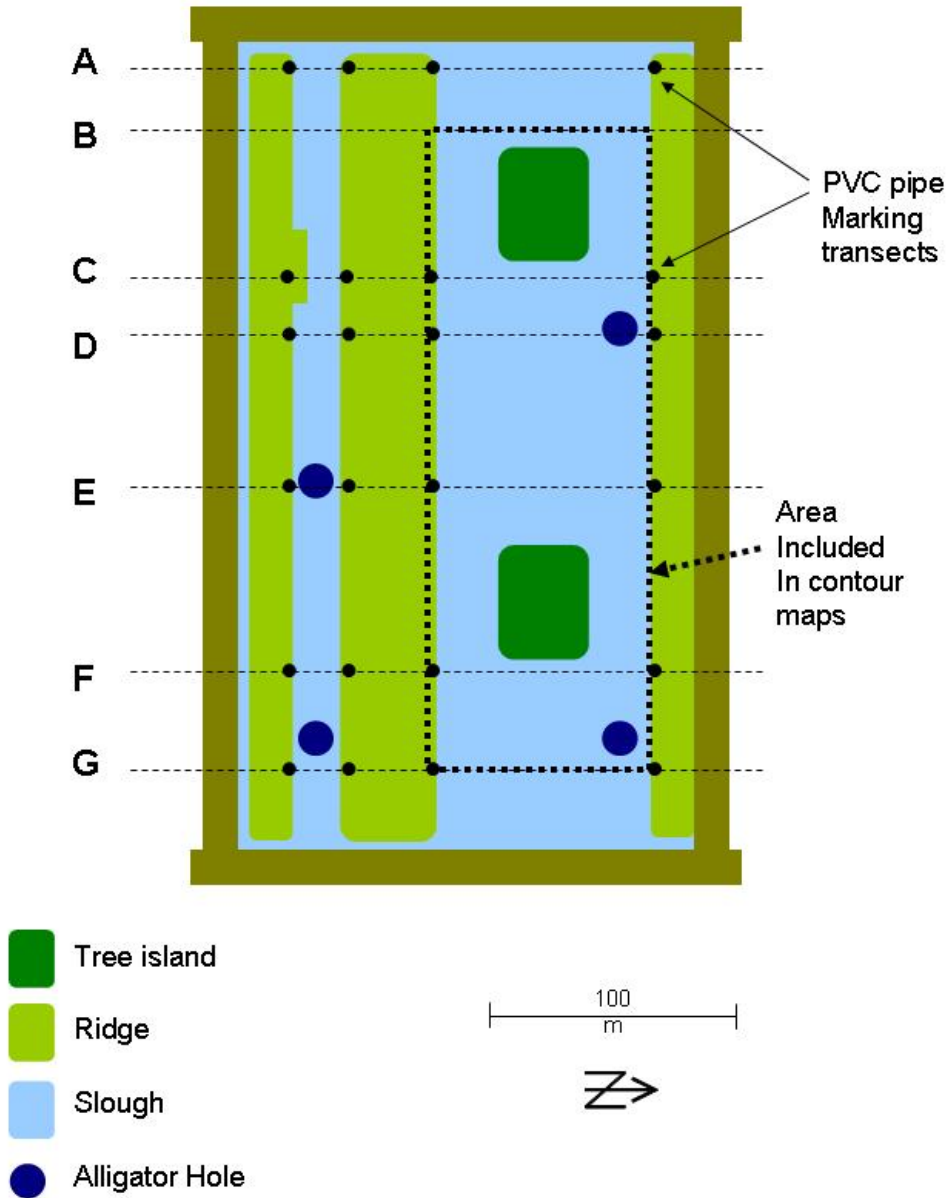

Figure 5.6. Generalized map of LILA mesocosm showing location of June 2006 transects.

Water, Flock and Soil Elevations at M1 in July 2006

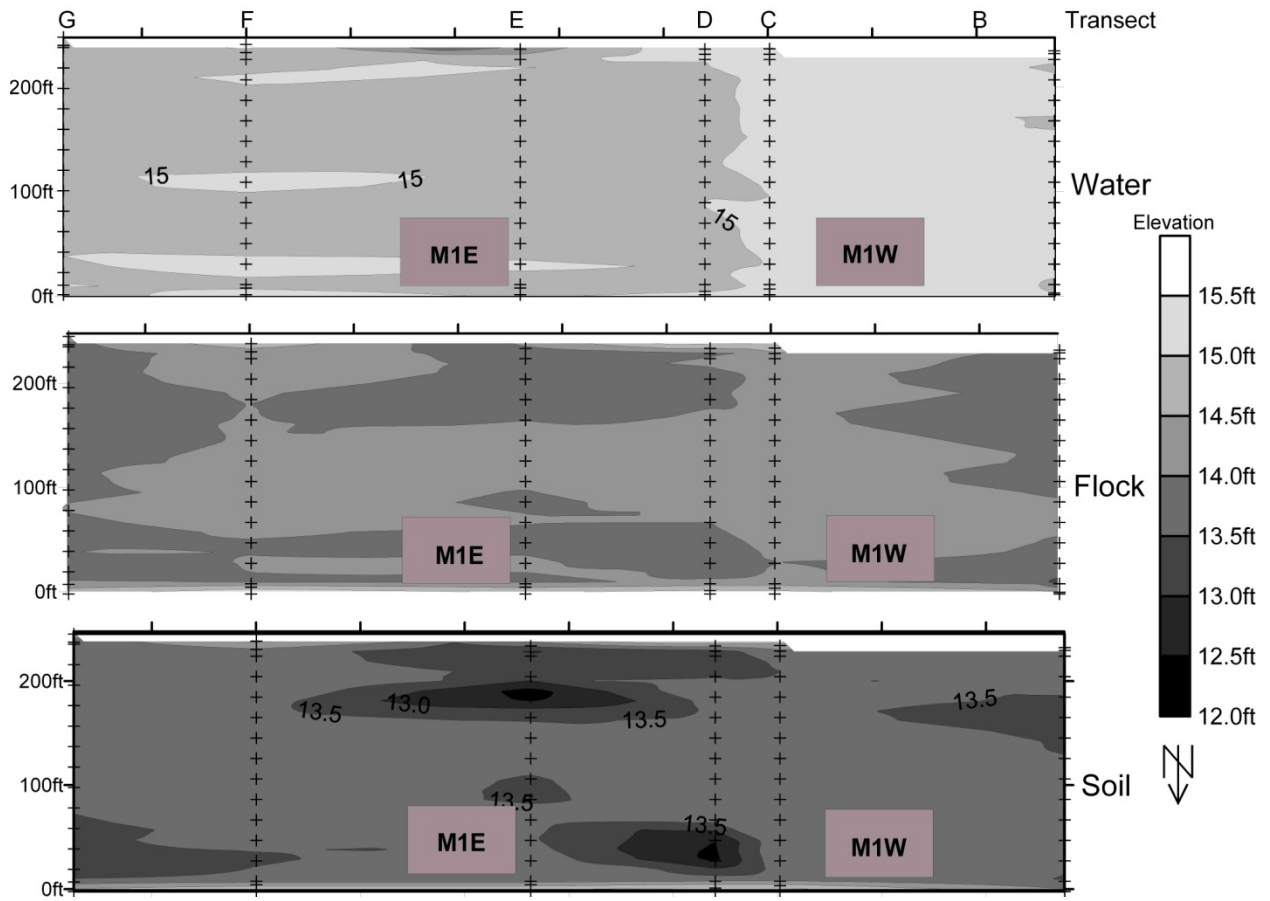

Figure 5.7. Elevations in feet of water level and top of flock and soil in M1 on July 2006.

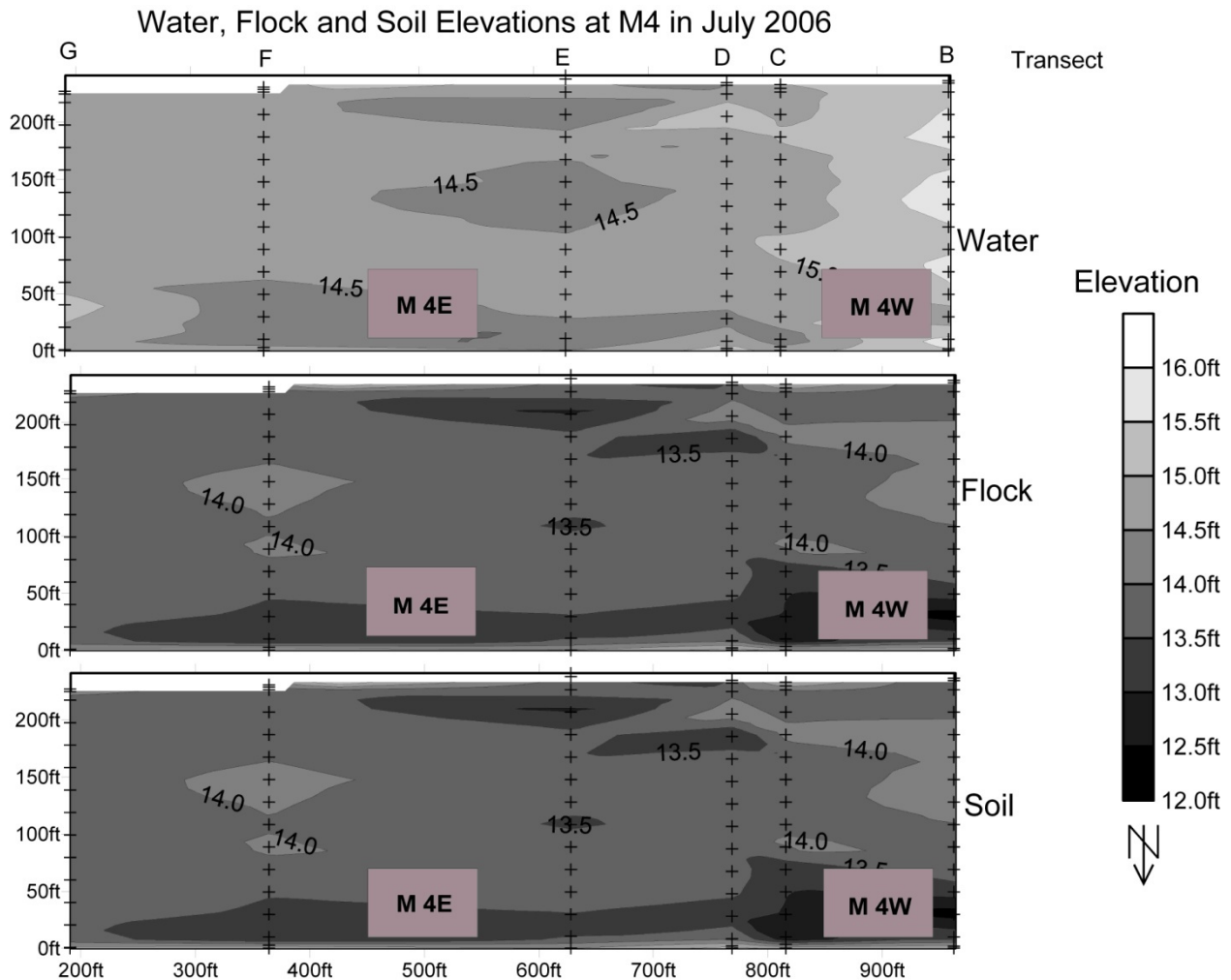

Figure 5.8. Elevations in feet of water level and top of flock and soil in M4 on July 2006.

Under the original contract, we planned to utilize digitized aerial photographs taken on approximately three year intervals to determine large scale changes in the expansion/shrinkage of landscape features (e.g. Tree Islands, Ridges, etc.) and changes in vegetation patterns. This would have resulted in two series of aerials, an initial and a final over the course of this contract. However, in collaboration with the SFWMD Photogrammetry Team of the Everglade's Division and, through a separate contract agreement with Pickett Surveying and Photogrammetry (Bartow, FL), we were able to obtain aerial photographs taken of the LILA site in the spring of 2000, 2003, and 2004 (before this contract) and again in 2006, 2007, and 2008 (during this contract period). Aerial photography was received as 1:1800 scale, digital orthography. Compilations of sequential aerial photography will, hopefully, provide georeferenced depictions of change in the system through time (e.g. tree island shape, ridge spreading or shrinking). Additionally, elevation data may be derived from 3D analysis of this aerial photography. One complication to using 3D imaging for surface elevation determination is the presence of water. Water obscures surface features making the elevation of flooded portions (e.g. soils) difficult or impossible to determine. We generally attempted to manage LILA water levels so that there was

a minimum of water during the collection of the photography. Occasionally (2007) delays caused by weather or contracting and insurance issues made it impossible to hold water levels low at the time that the photography was taken.

A series of images were developed with the GIS software which show the available aerial infra-red (IR) photos relative to the corner control points. The control points are marked in the field with standard black and white aerial targets which show up in all the images except the 2000 example. In order to determine the accuracy of the georeferencing of each image, the target in the SW corner was checked against the field GPS measurement for this location. Direct measurement of the target in 2008 using the tool in the GIS software showed it to be 0.046 m WSW of the field measured point. The software was used to calculate the geospatial coordinates of the targets in all the images and Table 1 shows these and the difference in meters from the field measurement. All images are within 0.6 m of the measured point with the 2008 and 2006 images coming closest to a match.

Table 1: Comparison of point coordinates (UTM Zone 17N meters).				
Point Type	Longitude	Difference	Latitude	Difference
		m		M
Field GPS point at SW corner.	577630.97656	0	2929685.896808	0
Aerial target at SW corner 2008 image.	577631.428211	0.45165	2929685.874694	-0.02211
Aerial target at SW corner 2007 image.	577631.444772	0.46821	2929685.801184	-0.09562
Aerial target at SW corner 2006 image.	577631.406364	0.42980	2929685.871017	-0.02579
Aerial target at SW corner 2004 image.	577631.570472	0.59391	2929685.776743	-0.12006
Aerial target at SW corner 2003 image.	577631.587894	0.61133	2929685.785099	-0.11171
Note: positive longitude differences are further west; negative latitude differences are further south.				

An additional check was made to determine the accuracy of the georeferencing using the boardwalk to Tree Island 3 West, which is located on the eastern side of the island near the center of the images. A line was drawn on the 2008 image corresponding to the center of the boardwalk (by using center of mass of the white pixels). The line was then superimposed on the other aeriels and that showed that they never deviated by more than ½ of the width of the boardwalk (~30 cm) in the east-west direction. The 2006 image most closely lined up with that of 2008, with the others being shifted to the east slightly (< 30 cm). Therefore, this analysis shows the aerial photos to be well georeferenced and usable for making direct measurements of items visible in the images. Measurements taken from the aeriels will be within 0.6 m of the actual location (or less). Georeferenced aeriels are included here as Figs. 5.9 to 5.14.

The development of our GIS overlay database has made it possible to spatially locate field plots, major instrumentation, and other “sensitive” areas. This serves several purposes, including preventing others from walking on or otherwise degrading a research plot, identifying past manipulations e.g. transplanted vegetation plots, nutrient additions, to explain possible future anomalies, and ultimately to link data in a visual, spatial way. For instance, periodic measures of sedimentation and erosion table (SET) data can be linked as an attribute table allowing anyone to bring up past data by selecting the point on the GIS overlay. Figure 5.15 shows the 2008 aerial photograph with the spatial locations of three experiments; the tree island SETs (white circles), the RAST plots (orange circles) and the locations of the 2008 M4 water velocity dye sampling points (yellow crossed circles).

Tasks 3a-d of the Scope of Work required two sets of surveys across the cells (Tasks 3a and b) and the incorporation of two sets of aerial photography into GIS overlays (Tasks 3c and d). As shown above, we have conducted two transect elevation surveys and have georeferenced six sets of aerial photography therefore satisfying the requirements of this task. Additionally, we have established benchmarks where needed, georectified as-built plans, conducted detailed tree island elevation measurements and georectified several active research sites.



Figure 5.9. Infra Red composite aerial photograph of LILA in 2000 also showing georeferenced benchmarks.

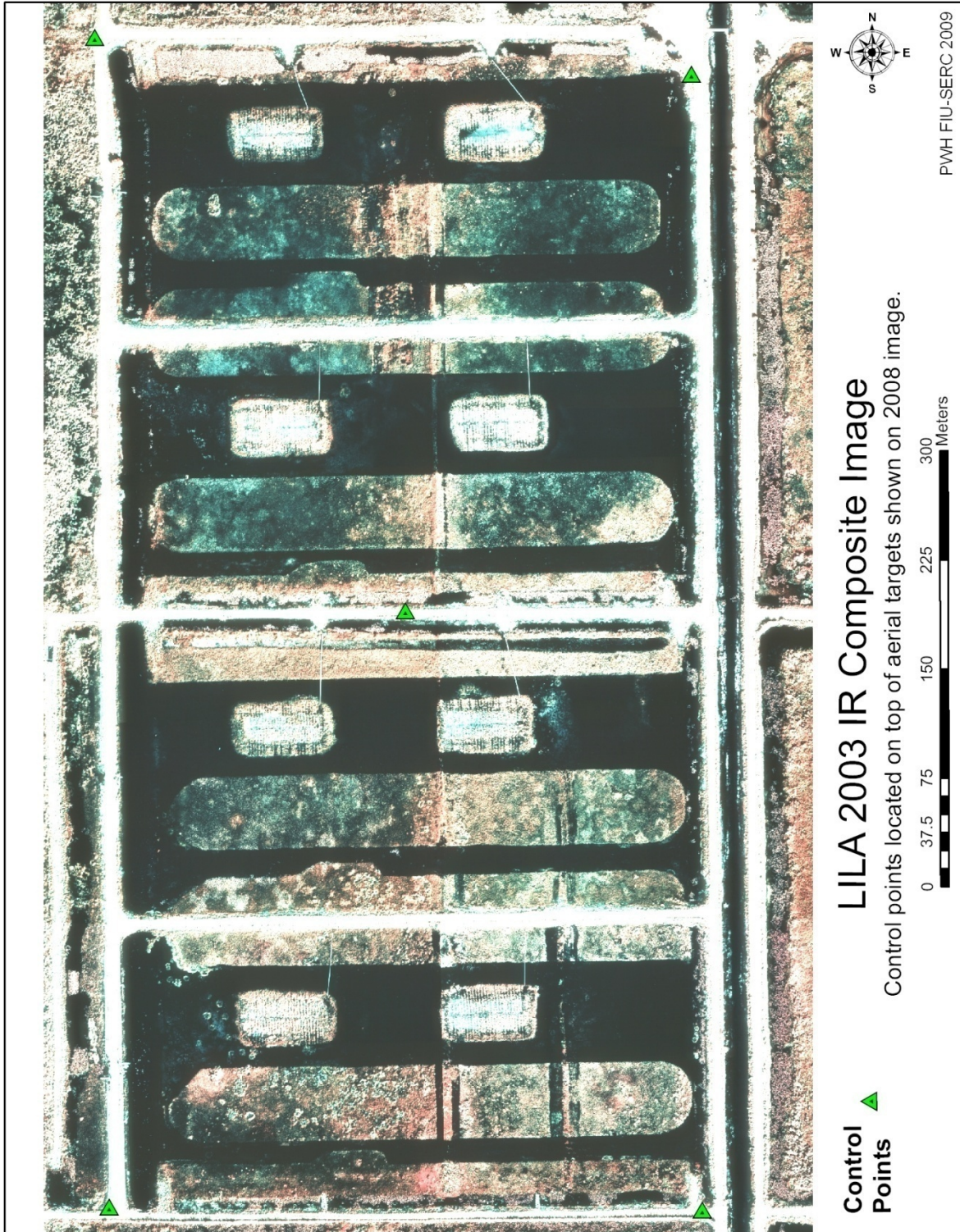

Figure 5.10. Infra Red composite aerial photograph of LILA in 2003 also showing georeferenced benchmarks.



Figure 5.11. Infra Red composite aerial photograph of LILA in 2004 also showing georeferenced benchmarks.

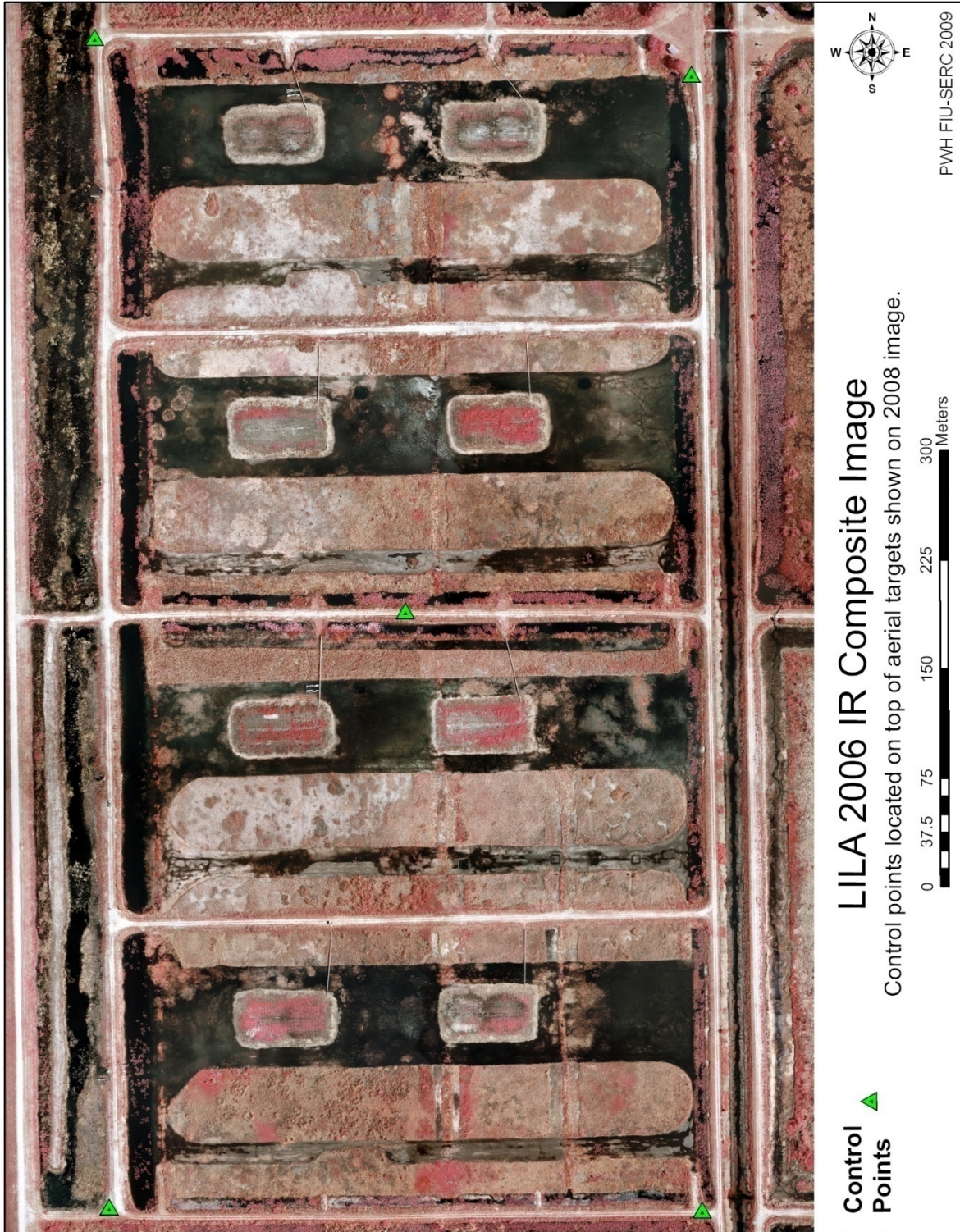

Figure 5.12. Infra Red composite aerial photograph of LILA in 2006 also showing georeferenced benchmarks.



Figure 5.13. Infra Red composite aerial photograph of LILA in 2007 also showing georeferenced benchmarks.



Figure 5.14. Infra Red composite aerial photograph of LILA in 2008 also showing georeferenced benchmarks.



Figure 5.15. 2008 aerial photograph showing locations of the tree island SETs (white circles), the RAST plots (orange circles) and the locations of the 2008 M4 water velocity dye sampling points (yellow crossed circles).

6. Task 4. Hydrology

There were two main objectives of the hydrology task: 1) establish infrastructure to provide for long-term monitoring of hydrologic conditions; and 2) document initial hydrologic conditions at LILA. Infrastructure was established to monitor both surface water and groundwater conditions at LILA. An operational hydrograph was established for LILA based upon average water levels observed for tree islands in Water Conservation Area 3A. Initial surface water flow conditions were monitored via several means including, transect surveys, dye tracer studies, and point flow monitoring under varying culvert operations. Groundwater wells were installed on all tree islands and groundwater levels were monitored in relation to surface water levels. Temperature was used as a hydrologic tracer of groundwater-surface water interactions.

6.1 Hydrologic Infrastructure

6.1.1 Surface Water

In 2005 and 2006, surface water levels inside of the cells at LILA were primarily monitored using staff gauges placed on either side of the inlet and outlet culverts. The staff gauges required someone to observe the water level and to manually record its value. Initially, only four automated stage recorders were operating at the LILA. Two were located on either side of the inlet culverts of M1 and M4 (Fig. 6.1). LILA staff (Eric Cline) coordinated with SFWMD to install 7 additional automated stage recorders in LILA (Fig. 6.1). These were placed inside cells M2 and M3 at the upstream end of the cells, as well as at the downstream ends inside all of the cells in November 2006. Data from all of the additional surface water gauges were obtained from the SFWMD DHYDRO (Table 6.1) by February 2007.

A 5-PSIG Level Troll 500 (In-Situ Inc.) pressure transducer was placed in the surface water slough just south of the center of island M1W on September 18, 2006, and then replaced on July, 20 2008 because of transducer failure. The pressure transducer was attached to a 3 ft-long vented cable. The vented cable allows for instantaneous equilibration of atmospheric pressure. Due to the extremely wet conditions at LILA, a number of precautions were taken to prevent moisture from entering the pressure transducer through the vented cable. A vented capsule of silica gel that attaches to the top of the vented cable is provided with each cable. This was augmented with a vented 250-mL plastic bottle filled with number 4 mesh drierite. The pressure transducer was suspended in a 2-inch PVC pipe using a stainless steel ring provided for this purpose from the manufacturer. The stainless steel ring is placed between a 2-inch (5.08 cm) PVC coupling and the PVC pipe to insure the pressure transducer remain stable. The PVC pipe was then attached to the metal bar in the slough next to M1 West with metal clamps. The PVC was covered with a 2-inch cap that was also vented to the atmosphere. The distance from the top of the PVC pipe to the bottom of the pressure transducer was measured to within 5 mm. The elevation of the top of the PCV pipe was determined using a Wild Nak-2 level and stadia rod which provided a 3mm level of accuracy. The elevation of the bottom of the pressure transducer in the surface water at M1 between 9/18/06 and 7/20/07 was 4.330 m (NGVD-29), and after 7/20/07 the elevation was 4.182 m (NGVD-29).

The pressure transducer was programmed to record water levels every 15 minutes. It had an internal battery that can last up to 5 years and an internal data logger that can hold 1 MB of

memory for over 100,000 data records. Its level of accuracy was $\pm 0.1\%$ of the full scale of 3.5 m (5 psi) which equates to ± 3.5 mm (0.0115 ft). The Level Troll 500 also measures temperature with an accuracy of $\pm 0.1^\circ\text{C}$. The water pressure was corrected for the water specific gravity, which was determined to be 0.95 using a hydrometer. This value was used in the software provided with the pressure transducer. Data from the pressure transducer was downloaded using a Rugged Reader (In-Situ, Inc.) about every 2 months. The data was stored on a computer at FIU.

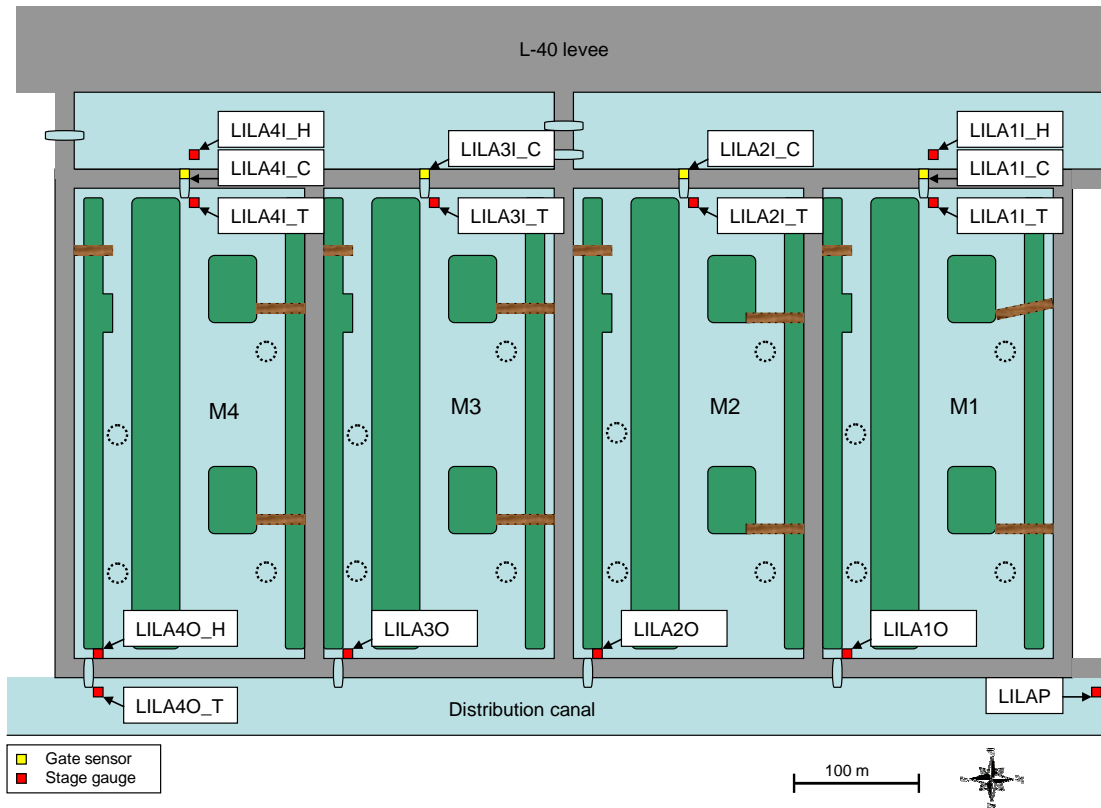

Figure 6.1 Location of all automated stage gauges (red squares) installed at LILA.

Table 6.1 - LILA stage and gate recorder information

Station	Latitude	Longitude	X Coord	Y Coord	Map	Description	Data Collection Start
LILA1I_C	262930.7	801315.9	910934.5	785238.7	Map	INFLOW 1 GATE	27-May-04
LILA1I_H	262930.7	801315.9	910934.5	785238.7	Map	INFLOW 1, HEADWATER	27-May-04
LILA1I_T	262930.7	801315.9	910934.5	785238.7	Map	INFLOW 1, TAIL WATER	27-May-04
LILA1O	262928.5	801301.3	912259.2	785026.6	Map	OUTFLOW	20-Feb-07
LILA2I_C	262923.8	801315.9	910933.0	784539.9	Map	INFLOW 2 GATE	27-May-04
LILA2I_T	262923.8	801315.9	910933.0	784539.9	Map	INFLOW 2, TAIL WATER	19-Jan-07
LILA2O	262921.5	801301.1	912286.1	784319.6	Map	OUTFLOW 2	20-Feb-07
LILA3I_C	262917.2	801315.9	910940.5	783873.9	Map	INFLOW 3 GATE	27-May-04
LILA3I_T	262917.2	801315.9	910940.5	783873.9	Map	INFLOW 3, TAIL WATER	1-Feb-07
LILA3O	262915.1	801301.1	912282.5	783673.8	Map	OUTFLOW 3	20-Feb-07
LILA4I_C	262911.2	801315.8	910954.9	783267.6	Map	INFLOW 4 GATE	27-May-04
LILA4I_H	262911.2	801315.8	910954.9	783267.6	Map	INFLOW 4, HEAD WATER	27-May-04
LILA4I_T	262911.2	801315.8	910954.9	783267.6	Map	INFLOW 4, TAIL WATER	27-May-04
LILA4O_ H	262908.2	801301.0	912301.5	782977.8	Map	HEADWATER AT OUTFLOW 4	20-Feb-07
LILA4O_ T	262908.2	801301.0	912301.5	782977.8	Map	TAILWATER AT OUTFLOW 4	20-Feb-07
LILAP	262947.8	801300.9	912280.2	786976.8	Map	PUMP HEADWATER	13-Jan-05

6.1.2 Groundwater

Nine wells points were installed on each of the tree islands (Fig. 6.2) for a total of 72 wells points spread over all eight tree islands. The original work plan included 12 well points per tree island. The number of well points was reduced to 9 per tree island when the small size of the tree islands was realized. Nine well points was adequate to describe the horizontal hydrologic conditions on each tree island. Prior to the installation of the well points in a cell, the surface water level in the cell was lowered to ≤ 14.5 ft. This allowed for the boreholes to remain open during well point installation. If water levels were kept high, then high groundwater pressure would cause the sides of the boreholes to cave in, and not allow the borehole to be advanced to the desired depth.

The well points were installed at two times. Well points were first installed on the tree islands in M1 and M4 in 2005 by FIU personnel. Well points in M2 and M3 were installed in 2006 by DNK Environmental under subcontract to SFWMD, and supervised by FIU personnel. At each well point location, a borehole was advanced to an approximate depth of 1.0 to 1.5 m below the ground surface. In M1 and M4 most of the boreholes were advanced using a 3 inch diameter bucket auger. Boreholes for the three center wells on tree islands M1west and M4west were advanced using a gasoline powered drill rig in order to drill through limestone boulders. The boreholes in M2 and M3 were advanced by first hammering a 4-inch diameter metal pipe to a depth of 1.0 to 1.5 m below the ground surface. Soil inside the metal pipe was then removed using a 3-inch bucket auger. The metal pipe was removed during installation of the well point. The average depth of these well points was 1.3 m (Table 6.2).

The well points were installed inside the boreholes and were constructed of 1-inch schedule 40 PVC pipe, with the lower 76 cm (2.5 ft) of 0.010 inch slotted well screen fitted at the bottom with a slip cap (Fig. 6.3). The well screen was threaded at the top to 152 cm (5 ft) of solid, 1-inch schedule 40 PVC pipe. Coarse-grained sand was placed around the annulus of the well screen and the borehole to a height of 5 cm (2 inches) above the well screen. Fine sand was then placed above the coarse sand to a thickness of at least 10 cm (4 inches). The remaining annulus of the borehole was filled with cement to the land surface. The fine sand placed between the cement layer and the underlying coarse sand, prevented the cement from entering the coarse sand and potentially clogging the well screen. This also allowed the well to be sampled for water quality should future needs warrant. The solid PVC pipe of each well extended from 80 to 125 cm above the ground surface. A 2-inch diameter PVC pipe was cemented at the ground surface and around the outside of the 1-inch PVC pipe to serve as a protective outer casing. The top of the 1 inch well was fitted with a machine slotted well cap that was vented to the atmosphere. Each of the wells was surveyed using a Wild Nak-2 level and stadia rod which provided a 3mm level of accuracy. The wells were surveyed multiple times to insure the accuracy of the surveying method. Survey points were located at the top of the 1-inch PVC pipe and were converted to elevations using rebar elevations located at the center of each island as a reference datum (Table 6.2).

Approximate location of Tree Island Wells

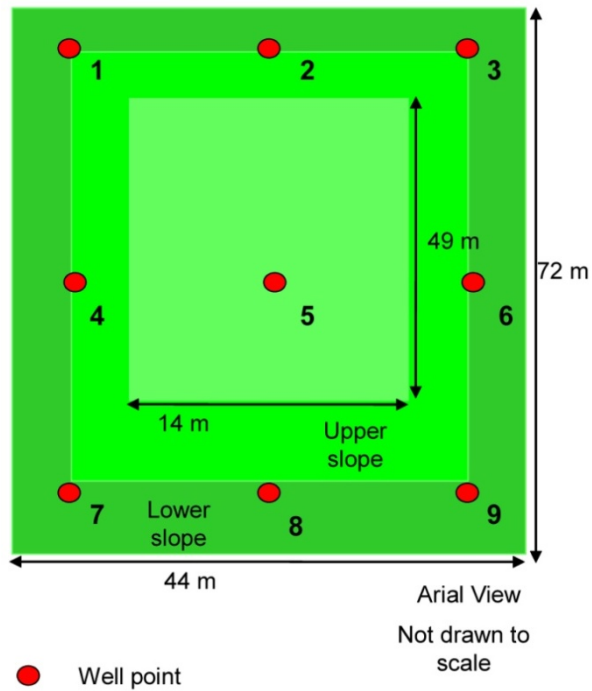

Figure. 6.2 Approximate location of well points on each tree island.

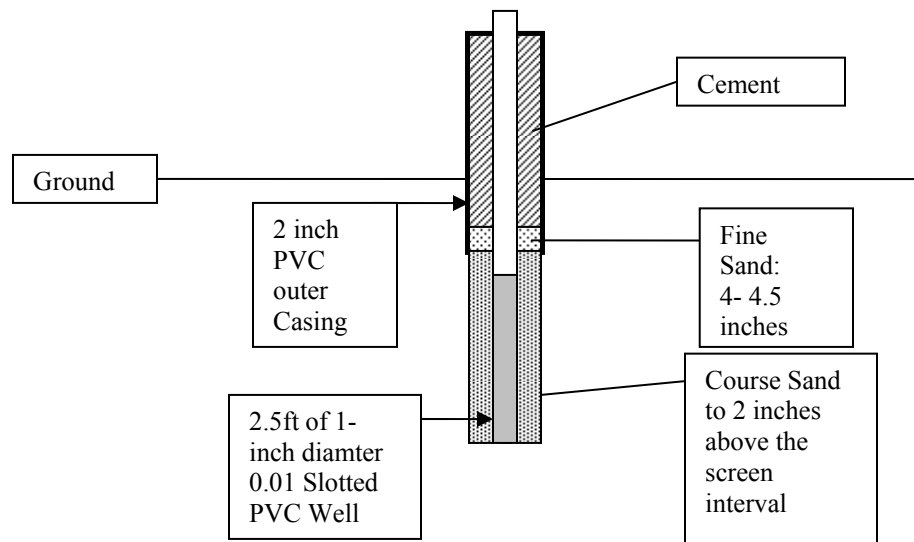

Figure 6.3. Schematic of well-point installation.

The well points on each tree island were named according to the following convention. The well name began with the letter M followed by a number 1 through 4. This designation corresponded to cells 1 through 4 which were located from north to south in LILA (Fig. 6.1). The next letter of the well name corresponded to the locations of the tree islands in each macrocosm. Islands located to the east were designated with the letter E while those to the west were represented with the letter W. The next character of the well name was a number from 1 through 9, which referred to the placement of the well on the tree island. Well #1 was always located on the southwest side of the island while well #9 was always located on the northeast side of the island (Fig. 6.2). The well designation M4W5 would be an example of the well numbering system and would be designated as a well in macrocosm 4 on the west tree islands in the 5th well.

Twenty-nine, 5-PSIG Level Troll 500 (In-Situ, Inc.) pressure transducers were installed in 1.34 m depth wells points on the tree islands. Ten pressure transducers were purchased by FIU under this contract. The remaining was purchased by the SFWMD. The original workplan mentioned 24 pressure transducers. Additional pressure transducers were purchased by SFWMD to meet added objectives of this project and others.

The pressure transducers were attached to a 6 ft-long vented cable. As for the surface water pressure transducer, the silica gel capsule located at the top of the vented cable was augmented with a vented 250-mL plastic bottle filled with number 4 mesh drierite. The drierite in the bottle was replaced every 4 months. The top of the cable and drierite bottle was enclosed inside of a 2-inch PVC outer casing at the top of each well point, and then capped with a vented 2-inch PVC well cap. The pressure transducer was suspended in each well from the vented cable that was attached to the top of the 1-inch well cap. The distance from the top of the well cap to the bottom of each pressure transducer was measured to within 5 mm. The pressure transducers were corrected for the water same specific gravity (0.95) values used for the surface water pressure transducer.

Initially pressure transducers were installed in all nine wells on peat core tree island M1W in September 2006 in order to determine the influence of water flow on groundwater levels. The following month pressure transducers were installed in the center wells of all tree islands in M1 and M4. Pressure transducers were installed in the center wells of all tree islands in M2 and the peat tree island in M3 following the tree planting in March 2007. Due to malfunction, the pressure transducer in the center of tree island M3L was not operational until September, 22, 2007. The pressure transducers in the center wells on all tree islands continued to operated.

On July 12, 2007, monitoring of all 9 pressure transducers on M1W ceased. The objectives of the groundwater monitoring shifted at that time to determine if a relationship existed between groundwater levels and tree-planting density **under a new contract between FIU and the SFWMD (PO #4500013487)**. To meet this later objective, 2 to 3 pressure transducers were installed in wells across the low to high tree-planting densities in all tree islands (Fig. 6.4).

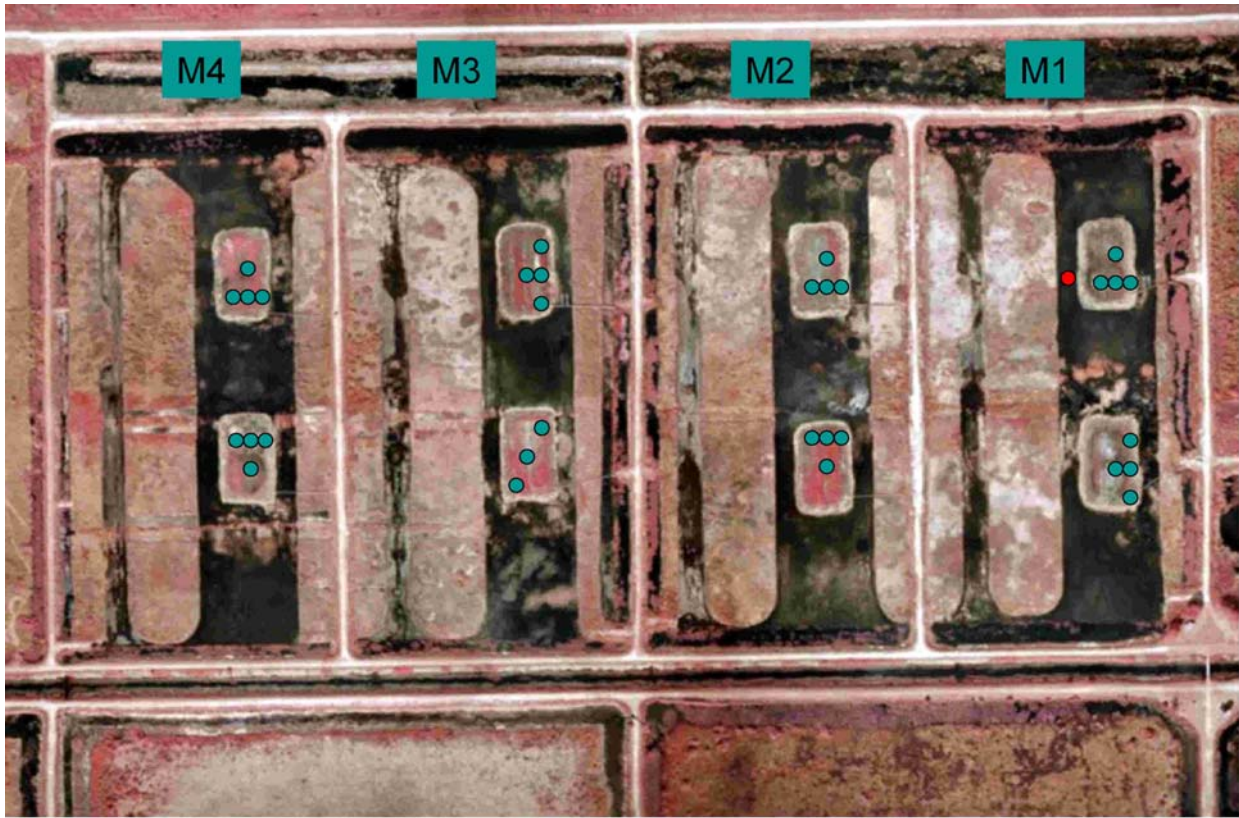

Figure 6.4. Location of pressure transducers in well points on tree islands from July 12, 2007 until present.

Table 6.2a. Summary of well point installation date, construction details and elevation for tree islands in cells M1 and M2.

Well name	Date Installed	Height Above Ground (m)	Thickness of Course Sand (m)	Thickness of Fine Sand(m)	Total Length of Well (m)	Well Depth (m)	Well Top Elevation NGVD-29 (m)	Bottom Elevation of Well NGVD-29 (m)
M1E1	3/29/2006	0.96	0.70	0.10	2.30	1.34	5.77	3.47
M1E2	3/30/2006	0.86	0.74	0.13	2.30	1.44	5.76	3.46
M1E3	3/29/2006	0.90	0.70	0.10	2.30	1.40	5.64	3.34
M1E4	3/30/2006	0.69	0.70	0.12	2.30	1.61	5.94	3.64
M1E5	3/30/2006	0.69	0.70	0.12	2.30	1.61	5.81	3.51
M1E6	3/30/2006	0.90	0.70	0.10	2.30	1.40	5.74	3.44
M1E7	3/30/2006	0.80	0.90	0.25	2.30	1.50	5.70	3.40
M1E8	3/29/2006	0.71	0.70	0.10	2.30	1.59	5.73	3.43
M1E9	3/30/2006	0.80	0.70	0.10	2.30	1.50	5.59	3.29
M1W1	4/13/2006	1.25	0.71	0.10	2.30	1.05	5.87	3.57
M1W2	4/13/2006	1.00	0.70	0.08	2.30	1.30	5.97	3.67
M1W3	4/13/2006	1.25	0.70	0.12	2.30	1.05	5.91	3.61
M1W4	4/13/2006	1.10	0.70	0.10	2.30	1.20	5.87	3.57
M1W5	4/13/2006	0.86	0.77	0.17	2.30	1.44	5.86	3.56
M1W6	4/13/2006	1.16	0.70	0.10	2.30	1.14	5.77	3.47
M1W7	4/14/2006	1.20	0.70	0.11	2.30	1.10	5.97	3.67
M1W8	4/14/2006	0.78	0.70	0.11	2.30	1.52	5.78	3.48
M1W9	4/14/2006	1.23	0.70	0.10	2.30	1.07	5.90	3.60
M2E1	10/10/2006	0.98	0.81	0.10	2.18	1.20	5.72	3.54
M2E2	10/10/2006	0.87	0.70	0.18	2.27	1.41	5.80	3.53
M2E3	10/10/2006	1.03	0.79	0.10	2.25	1.22	5.79	3.54
M2E4	10/10/2006	0.96	0.75	0.10	2.23	1.27	5.78	3.55
M2E5	10/10/2006	0.72	0.83	0.10	2.15	1.43	5.68	3.53
M2E6	10/10/2006	1.02	0.87	0.09	2.25	1.23	5.80	3.55
M2E7	10/10/2006	0.94	0.76	0.10	2.18	1.24	5.74	3.56
M2E8	10/10/2006	0.77	0.98	0.10	2.25	1.48	5.77	3.52
M2E9	10/10/2006	1.04	0.76	0.09	2.24	1.20	5.82	3.58
M2W1	10/9/2006	1.07	0.78	0.09	2.29	1.22	5.78	3.49
M2W2	10/20/2006		1.05	0.09		1.54	5.81	
M2W3	10/9/2006	1.02	0.76	0.09	2.28	1.26	5.75	3.47
M2W4	10/9/2006	1.01	0.77	0.09	2.30	1.30	5.75	3.44
M2W5	10/20/2006	0.78	0.86	0.11	2.29	1.50	5.77	3.49
M2W6	10/9/2006	0.98	0.76	0.09	2.25	1.27	5.75	3.50
M2W7	10/9/2006	1.07	0.84	0.09	2.28	1.21	5.77	3.49
M2W8	10/20/2006	0.84	1.01	0.12	2.29	1.45	5.76	3.48
M2W9	10/9/2006	1.07	0.78	0.15	2.28	1.21	5.89	3.61

Table 6.2b. Summary of well point installation date, construction details and elevation for tree islands in cells M3 and M4.

Well name	Date Installed	Height Above Ground (m)	Thickness of Course Sand (m)	Thickness of Fine Sand(m)	Total Length of Well (m)	Well Depth (m)	Well Top Elevation NGVD-29 (m)	Bottom Elevation of Well NGVD-29 (m)
M3E1	10/12/2006	1.00	0.84	0.11	2.26	1.26	5.74	3.48
M3E2	10/12/2006	0.78	0.83	0.22	2.30	1.52	5.79	3.49
M3E3	10/12/2006	1.00	0.90	0.09	2.28	1.28	5.76	3.48
M3E4	10/12/2006	1.04	0.83	0.09	2.26	1.23	5.75	3.48
M3E5	10/12/2006	0.86	0.76	0.15	2.30	1.44	5.73	3.42
M3E6	10/12/2006	1.08	0.76	0.10	2.26	1.19	5.74	3.48
M3E7	10/12/2006	1.15	0.81	0.09	2.26	1.11	5.74	3.48
M3E8.	10/12/2006	0.93	0.78	0.16	2.27	1.34	5.75	3.48
M3E9	10/12/2006	1.04	0.76	0.10	2.24	1.20	5.72	3.48
M3W1	10/13/2006	1.11	0.76	0.09	2.26	1.16	5.75	3.49
M3W2	10/20/2006		0.92	0.14		1.47	5.75	
M3W3	10/13/2006	1.08	0.80	0.09	2.29	1.20	5.75	3.47
M3W4	10/13/2006	1.08	0.77	0.10	2.28	1.21	5.78	3.49
M3W5	10/20/2006	0.75	0.77	0.12	2.26	1.51	5.73	3.47
M3W6	10/13/2006	1.05	0.79	0.10	2.28	1.23	5.76	3.48
M3W7	10/13/2006	1.02	0.76	0.10	2.21	1.19	5.67	3.46
M3W8	10/20/2006	0.87	0.82	0.18	2.25	1.38	5.73	3.48
M3W9	10/13/2006	1.10	0.70	0.12	2.26	1.16	5.73	3.46
M4E1	4/17/2006	1.08	0.70	0.12	2.30	1.22	5.72	3.42
M4E2	4/17/2006	0.85	0.75	0.10	2.30	1.45	5.91	3.61
M4E3	4/17/2006	0.86	0.70	0.10	2.30	1.44	5.61	3.31
M4E4	4/17/2006	0.97	0.71	0.10	2.30	1.33	5.60	3.30
M4E5	4/17/2006	0.87	0.78	0.10	2.30	1.43	5.92	3.62
M4E6	4/17/2006	0.95	0.70	0.11	2.30	1.35	5.60	3.30
M4E7	4/17/2006	1.00	0.70	0.12	2.30	1.30	5.70	3.40
M4E8	4/17/2006	0.75	0.70	0.10	2.30	1.55	5.74	3.44
M4E9	4/17/2006	0.99	0.70	0.10	2.30	1.31	5.59	3.29
M4W1	4/13/2006	1.17	0.70	0.10	2.30	1.13	5.80	3.50
M4W2	4/13/2006	0.80	0.88	0.23	2.30	1.50	5.72	3.42
M4W3	4/14/2006	1.20	0.70	0.13	2.30	1.10	5.82	3.52
M4W4	4/13/2006	1.23	0.70	0.11	2.30	1.07	5.91	3.61
M4W5	4/13/2006	0.77	0.70	0.12	2.30	1.53	5.71	3.41
M4W6	4/13/2006	1.10	0.70	0.13	2.30	1.20	5.86	3.56
M4W7	4/14/2006	1.18	0.71	0.10	2.30	1.12	5.69	3.39
M4W8	4/13/2006	0.80	0.82	0.10	2.30	1.50	5.74	3.44
M4W9	4/13/2006	1.18	0.70	0.10	2.30	1.12	5.91	3.61

6.1.3. Hobo Temperature sensors

To provide better spatial coverage of groundwater-surface water interactions in the sloughs, ten HOBO™ U22 Water Temp Pro v2 loggers were placed in the surface water of the sloughs in M1 and M2. The HOBO U22s were evenly dispersed across two transects that span from the edge of the eastern tree islands through the slough to the edge of the ridge (Figure 6.5). These temperature probes operated at a range of -20 to 70 °C with an accuracy of 0.2 °C. The U22 loggers had a memory of 64K bytes and recorded at a 30-minute collection rate. Each logger was covered by a 5.08 cm PVC cap that was open at the bottom, to reduce any influence of direct sunlight. Each of the five loggers was attached to one guide wire anchored on the tree islands and ridges.

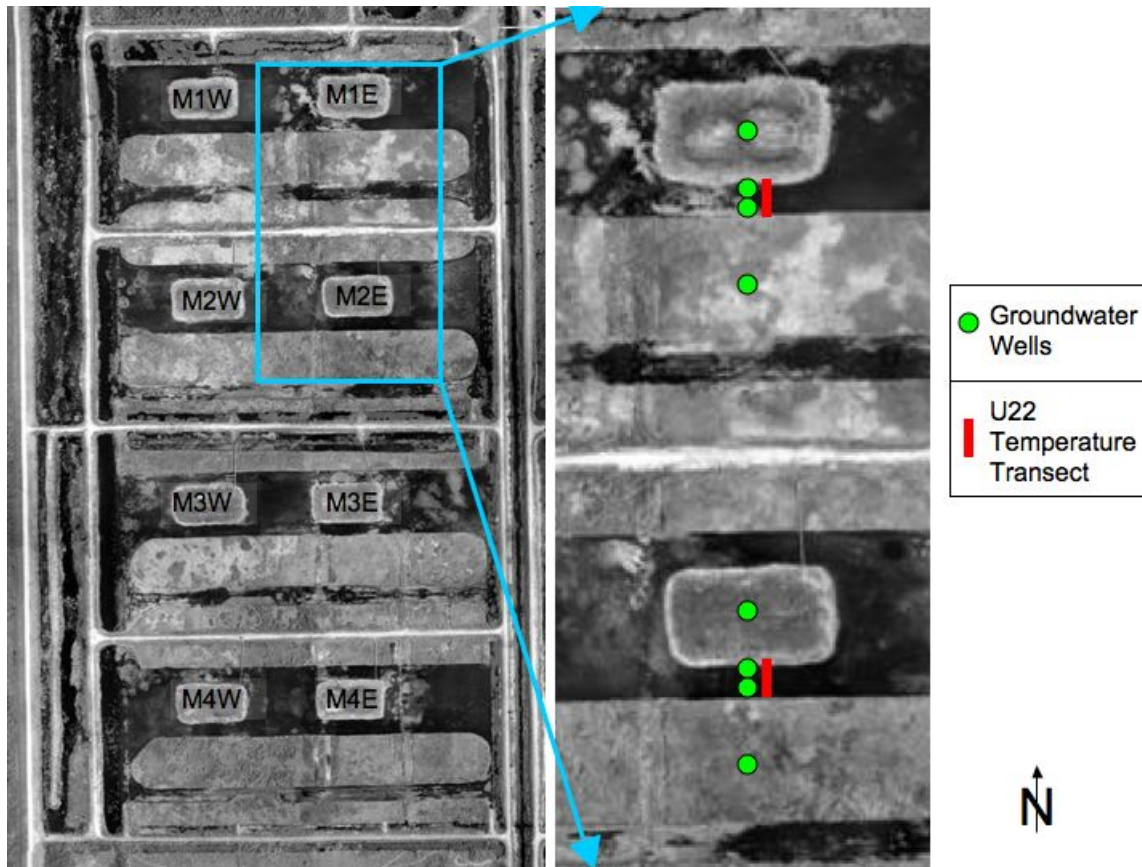

Figure 6.5. Transects of 5 U22 temperature sensors are located in the slough between the tree islands of M1E and M2E and their corresponding ridge. Locations of groundwater well transects (green) are shown comparison.

6.1.4 LILA Weather Station:

The LILA weather station is located on the Loxahatchee wildlife refuge in LILA macrocosm 2 West (M2W). It has been collecting data since the initial start date of 12/05/07. The instrument used is a HOBO Weather Station and is currently recording 10 channels of measurements, but can record up to 15. This information is transmitted via radio signal from the instrument to the LILA facilities trailer (about .5 miles away), where it is downloaded weekly and saved on the FIU main computer. The measurements that we record on site are:

- **Leaf Wetness** – measured in a saturation percentage 0% (dry) - 100% (wet).
- **Barometric Pressure** - measures average barometric pressure for each logging interval over the range of 660 mb to 1070 mb.
- **Wind speed** -measures average wind speed 0 to 44 m/s (0 to 99 mph)
- **Wind Gust** - highest three second wind gust and average (unit vector average) 0 to 44 m/s (0 to 99 mph).
- **Wind Direction**- 0 to 350 degrees compass direction.
- **Photosynthetic Light (PAR)** - measures light intensity for the frequencies relevant for photosynthesis. This sensor has a measurement range of 0 to 2500 $\mu\text{mol}/\text{m}^2/\text{sec}$ over wavelengths from 400 to 700 nm.
- **Soil Moisture**- measures 0 to saturated VWC (Volumetric Water Content) at a range of - 0.29 to 1.4475 m^3/m^3
- **Temperature** - -40° to 100°C (-40° to 212°F).
- **Temperature/RH Smart Sensor** - Temp: -40°C to 75°C (-40°F to 167°F) RH: 0-100% RH at -40° to 75°C (-40° to 167°F); exposure to conditions below -20°C (-4°F) or above 95% RH may temporarily increase the maximum RH sensor error by an additional 1%.
- **Rain**- Total rain collected in 0.01 inches.

Figure 6.1.4.1 is a graphical representation of two of these measurements, wind speed and direction.

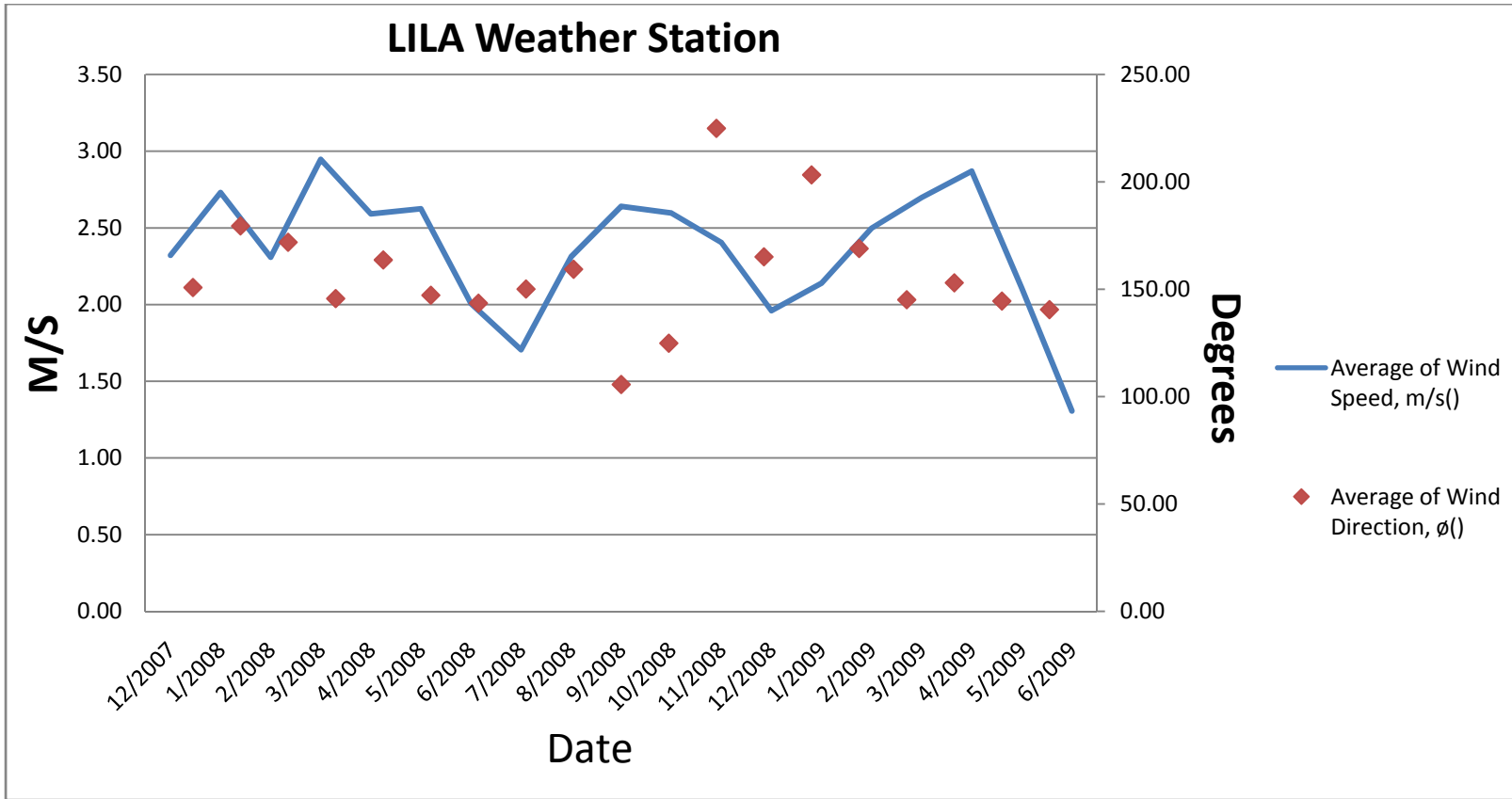

Figure 6.1.4.1. Wind speed and direction as recorded at the LILA M2W weather station.

6.2 Surface water Monitoring

6.2.1. Hydrograph

An operational hydrograph (Fig. 6.6) was developed based on tracking the historic water levels recorded in a well-established Everglades water level recorder (3ASW1) to predict the stage levels to be maintained in the LILA cells during routine operation, that is, when not predetermined based on a specific experimental protocol. This operational hydrograph was based on water levels that would mimic those seen in the real system with slight adaptation to the LILA system. For instance, it was decided during a LILA Science Coordination Meeting (September 15th, 2006) that water levels measured by 3ASW1 during the driest portion of the year (red symbols in Fig. 6.6) be lowered by 15 cm to achieve drying of the shallow sloughs. Using this hydrograph, water depths were maintained for a period of approximately two weeks and changed according to seasonal schedules. At times, the water levels were manipulated depending on experimental needs but would form the background depths during most routine operation. This operational hydrograph went into effect on August 14th, 2006.

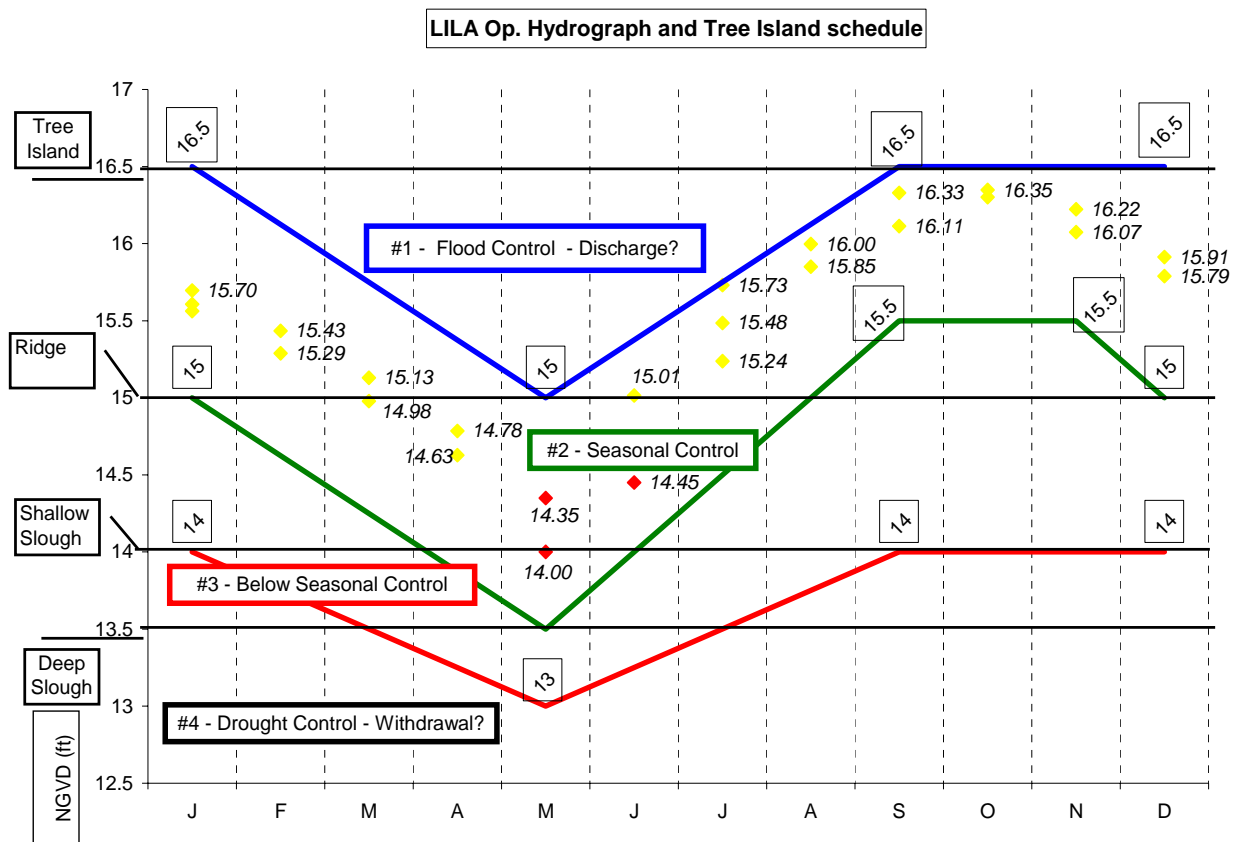

Figure 6.6. Operational hydrograph based on seasonal water levels monitored at a tree island in WCA-3A and adapted for conditions at LILA. Stage will be set to maintain these water levels (yellow and red diamonds) unless superseded by experimental protocols.

6.2.2 Surface Water Levels

Water levels in M1 through M4 along with rainfall amounts from January 2006 through May 2009 are depicted in Figure 6.7. The surface water levels varied seasonally and tended to fall within the flood and operational hydrographs. The tree islands in M1 and M4 were completely submerged in February 2006 for vegetation management prior to planting of trees on those islands and then again throughout October 2006. Tree islands in M2 and M3 were flooded in February 2007 just prior to planting of trees on those islands. Water levels in M1 and M4 were lowered to below the operational hydrograph in January 2007, January 2008, and February 2009 for the bird feeding study conducted by FAU. In August 2007, water levels in all four cells were kept below the operational hydrograph for the aerial photography. The surface water hydrographs of all four cells tended to be similar and less variable from September 1, 2008 until May 31, 2009.

Daily averaged surface water levels in M1 through M4

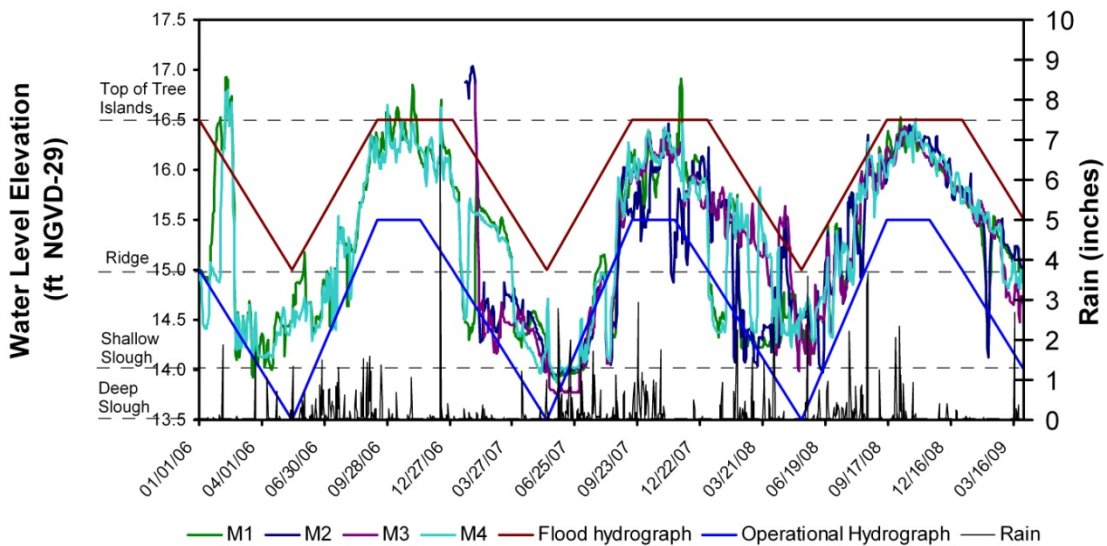

Figure 6.7. Surface water levels in M1 through M4 compared to the flood and operational hydrographs, and rainfall amounts from Jan. 1, 2006 until May 31, 2009.

6.2.3. Surface Water Flow Transects

Water depth and flow velocity measurements were made along the transects in all four cells during the first year when water levels were near 4.6 m (15 ft) in elevation (Table 6.3; Fig. 6.8 for transect arrangement). This water level elevation corresponded to an intermediate water depth or about 50% of the maximum potential water depth between the bottom of the deep slough elevation of 4.2 m and the top of the tree islands at about 5.0 m. Additional surveys of water depth and flow velocity measurements were made in cells M1 and M2 in October 2007 during the first part of year 2 (Table 6.3). Those

measurements were made at a high water level elevation of 4.9 to 5.0 m (15.9 to 16.5 ft) corresponding to a water level that floods the tree islands.

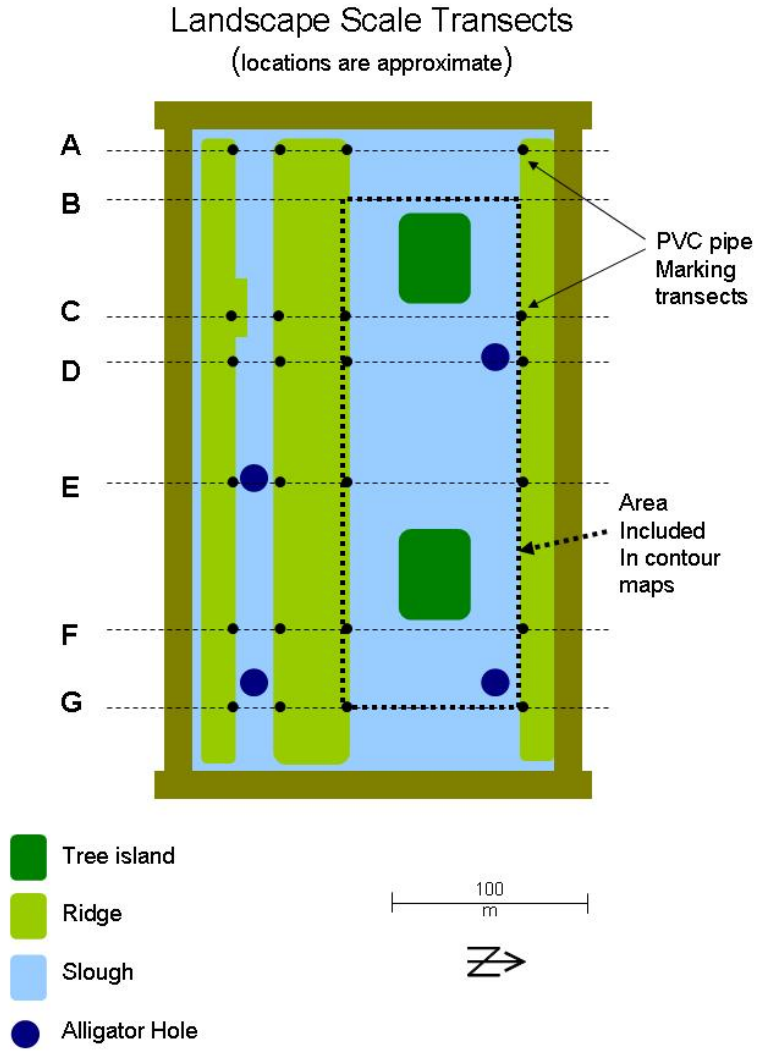

Figure 6.8. Location of transects used for water velocity measurements.

Table 6.3. Summary of dates and water levels during velocity measurements made in years 1 & 2.

Mesocosm	Date	Water Elevation (m)	Water Elevation (ft)
M1	January 19, 2006	4.6 m	15.1 ft
M2	July 11, 2006	4.6 m	15.3 ft
M3	July 17, 2006	4.6 m	15.2 ft
M4	July 31, 2006	4.6 m	15.1 ft
M1	October 17, 2006	5.0 m	16.5 ft
M2	October 31, 2006	4.9 m	15.9 ft

Flow velocity measurements were recorded using a SONTEK Flow Tracker. Velocity in both the X and Y directions were recorded at a distance of 3 meters from the northern shoreline of the deep slough and then every 6 meters thereafter. The positive X direction was toward the east, perpendicular to the transect line. The positive Y direction was to the north in the same direction as the transect line. Flow measurements were made at 0.6 times the water depth measured from the bottom of the water column. The direction and magnitudes of the velocities recorded in the X and Y directions were input to the program SURFER, which determined the resulting velocity vector for each measurement. The magnitude and direction of the velocity obtained in the X direction was combined with the water depth to determine water discharge for each 6 meter section.

Plots of the flow velocity and discharge measurements for each sampling date are included in Figures 6.9 through 6.13. Only two velocity transects were completed in M2 on July 11, 2006 due to poor weather conditions, and therefore, the data obtained from that day were not included into the SURFER program. Histograms of the velocities obtained in each cell are included in Figure 6.14. Velocities obtained ranged from -4 cm/s to +4 cm/s. The highest flow rates tended to be near the eastern end of each cell. Low flow velocities with varying directions tended to occur close to the tree islands. In the sloughs, higher flow rates tended to be located in the center of the sloughs, away from the edges.

In an attempt to determine flow rates within the cells in relation to pump operations, seven SONTEKs were placed in cell 2 on March 15, 2007 (Fig. 6.15). These flow meters consisted of one uplooker placed in each of the inlet and outlet culverts (numbers 8 and 5 of Fig. 4.12), a sidelooker attached to the set platform (number 9 on Fig. 6.15), and 4 downlookers placed throughout the cell (numbers 10-13 on Fig. 6.15). Five days of data collected from March 15 to March 20, 2007 are included on Fig. 6.15. This data included the average hourly flow rate recorded by the downlooking SONTEK at station 11, as well as the head difference across the inlet culvert to M2 and across the entire cell of M2. At 5:00 pm on March 15, the gate opening to the inlet canal of M2 was opened 0.25 ft. At that time there was a maximum difference of 2 ft between the water level in the inlet canal (16.6 ft) and the water level at the discharge side of the culvert (14.6 ft). Upon opening of the gate (0 hour), the difference in head across the inlet culvert decreased to a low value of 1.14 ft at hour 18, then increased to a level near 1.45 ft at hour 30 and then remained close to that level for the remaining 3.5 days of the test (Fig.

6.16). During the first 17 hours after the gate opening, the head difference across the entire cell remained low at about 0.08 ft, but by hour 19 it had increased to 0.15 ft, and then remained near that level for the remainder of the test. Prior to the gate opening, flow velocity at station 11 was close to zero. Upon opening of the gate, the flow velocity at station 11 increased 1.2 cm/sec within the first hour, but then decreased over the next 17 hours to zero and then to a negative 0.5 cm/sec, indicating that flow was towards the west at that time. From 18 to 37 hours after the inlet gate was opened, the average hourly flow rate recorded at station 11 increased to 1.7 cm/sec. After that time, the flow rate at station 11 ranged between +0.84 and +2.10 cm/sec and averaged 1.35 cm/sec.

The results of water management operations so far suggest that flow rates exceeding 2 cm/s can be obtained in at least 1 cell when the average water level in the cell is close to 15 ft with a 0.2 ft head difference maintained from the western to the eastern ends of the cell. A minimum of 36 hours is needed to establish stable water flow conditions in the cell. Some of the flow velocity and discharge measurements reported in this section were taken within 13 to 24 hours of the gate opening, and therefore, most likely do not represent stable flow conditions within the cells. To better determine surface water flow directions and rates at LILA, dye tracer studies were proposed and the original contract was amended to include those studies. The results of the dye tracer studies are included in section 6.2.5.

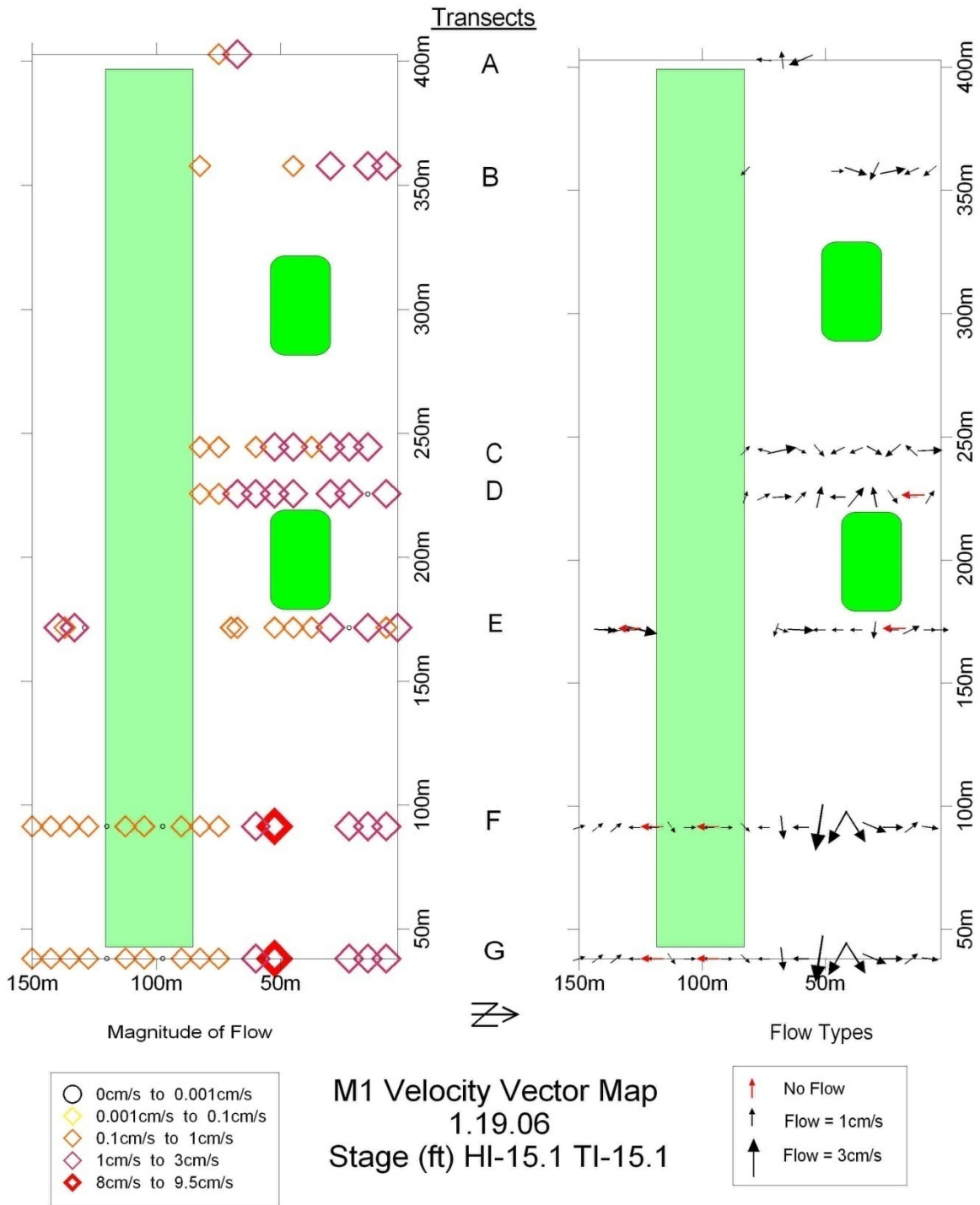

Figure 6.9. Velocity transects in M1 on January 19, 2006.

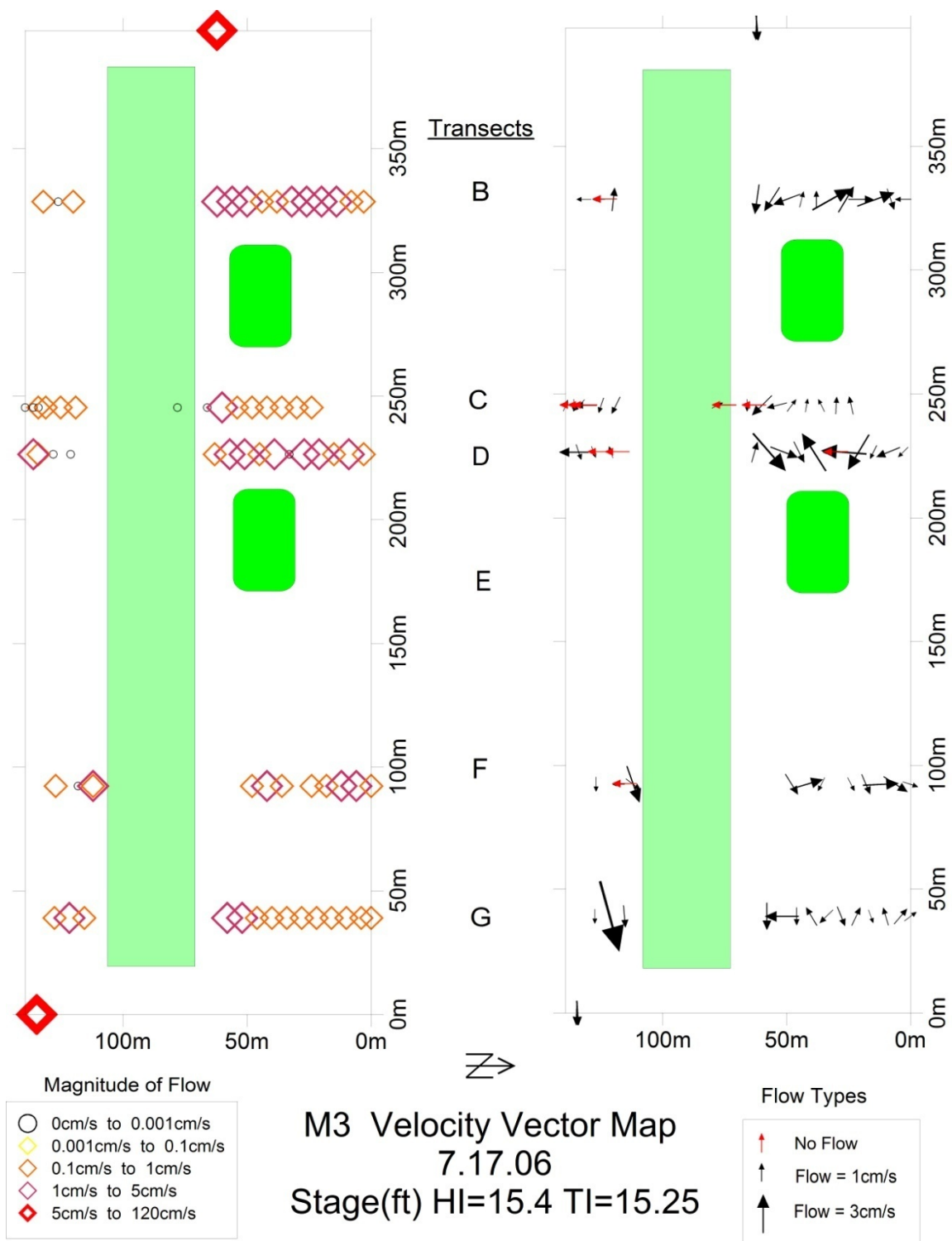

Figure 6.10. Velocity transects in M3 on July 17, 2006.

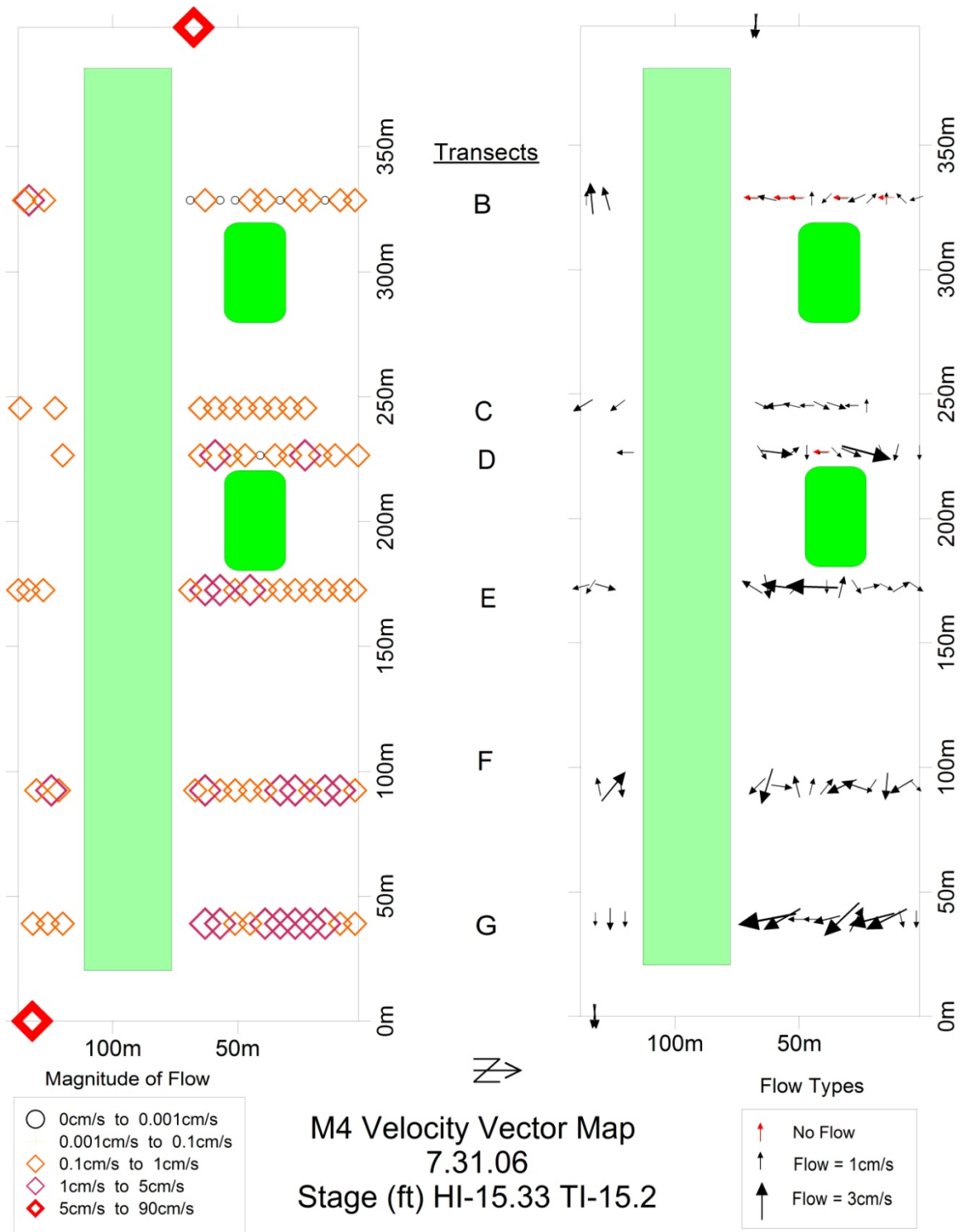

Figure 6.11. Velocity transects in M4 on July 31, 2006.

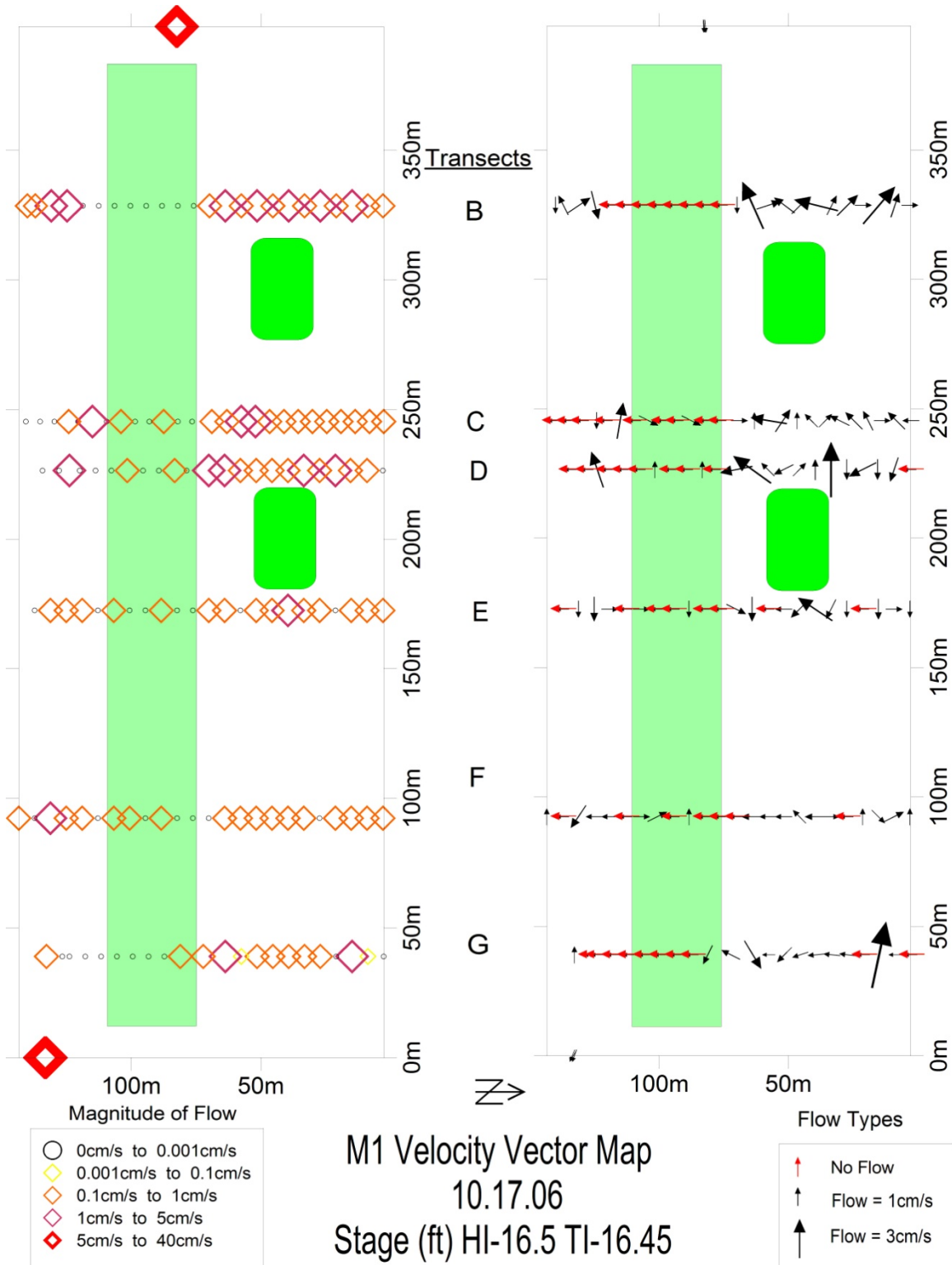

Figure 6.12. Velocity transects in M1 on October 17, 2006.

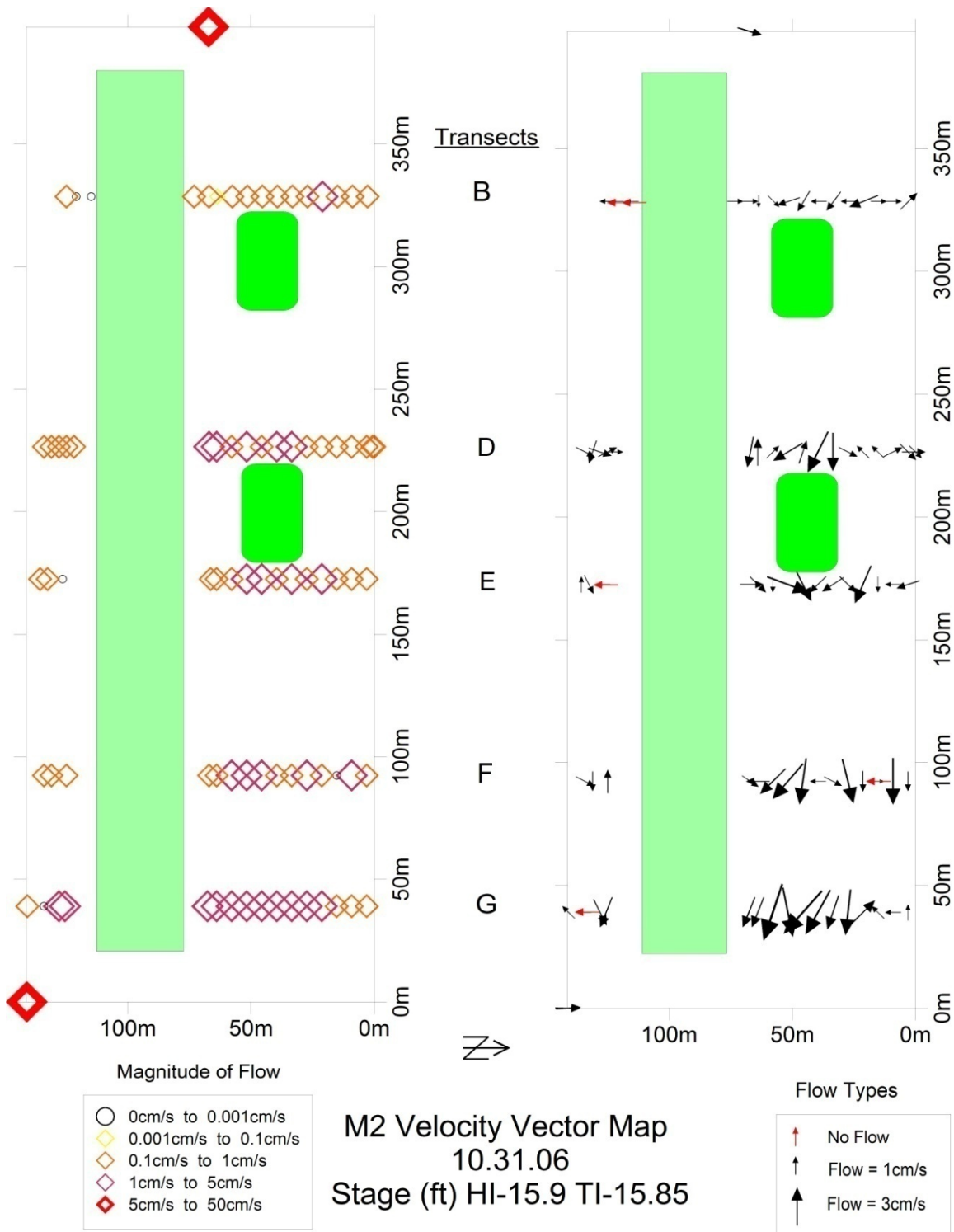

Figure 6.13. Velocity transects in M2 on October 31, 2006.

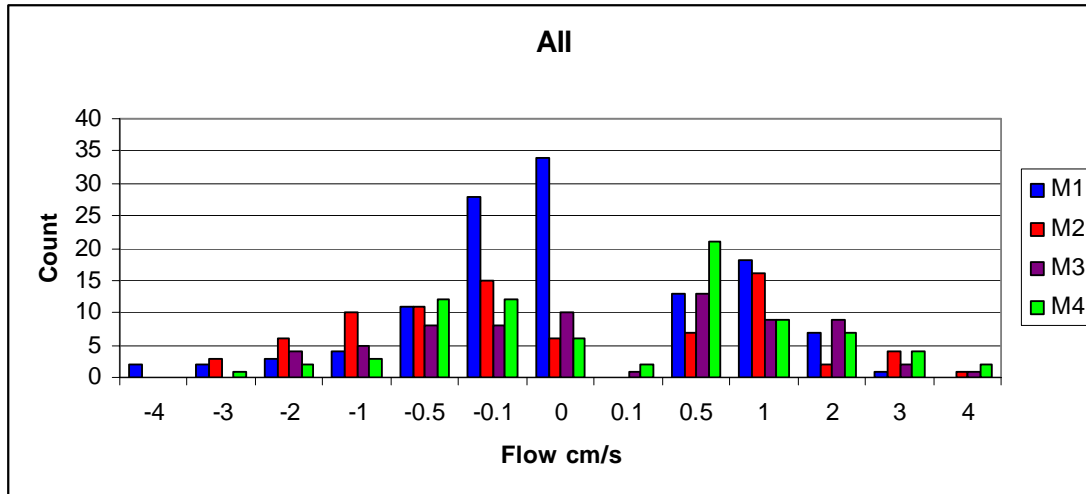

Figure 6.14. Histogram of all flow velocities measured along the transects in all cells.

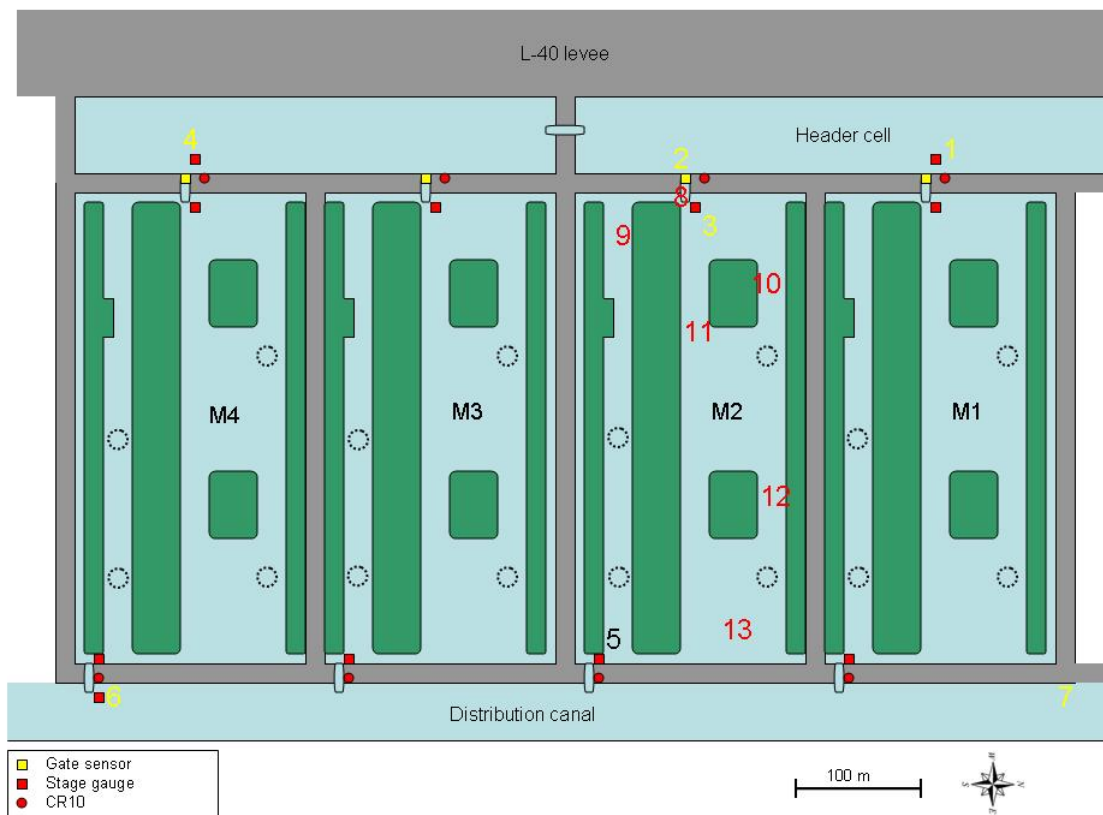

Figure 6.15. Location of Sonteks placed in M2. Numbers 5 and 8 were uplookers placed inside of the culverts. Number 9 was a side looker attached to the SET platform. Numbers 10 through 13 were downlookers.

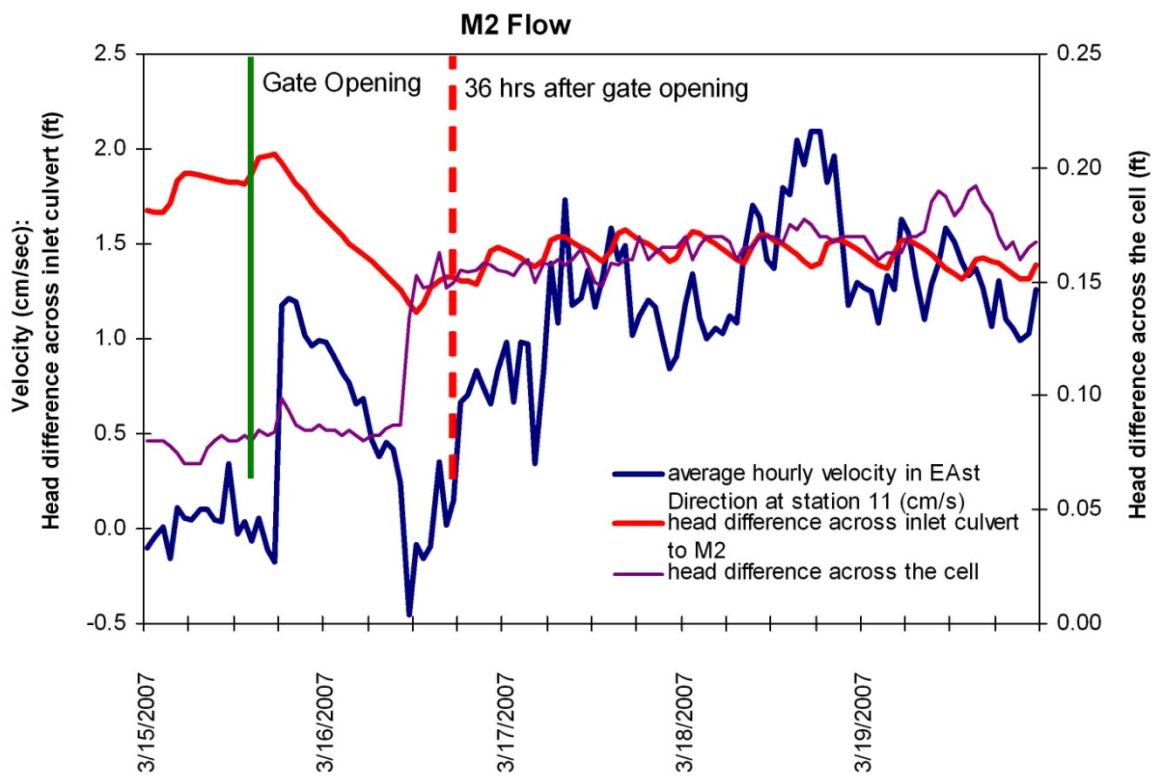

Figure 6.16. Graph of mean daily difference in head level across the inlet culvert and cell in M2, along with the mean daily flow velocity as measured by the downlooking SONTEK placed at location 11 on Figure 6.15.

6.2.4 Culvert flow analysis

Flow velocities and discharge rates were determined in both the cells' inlet and outlet culverts during each of the velocity transects performed between January and October 2006. Discharge from both the inlet and outlet culverts in all 4 cells were combined onto one graph to indicate that the highest discharge rates through the culverts that could be obtained when a head difference across the culvert was about 0.3 m or 1.2 ft (Fig. 6.17). Water flow was highest through a culvert when the culvert was half full. With water levels higher than the diameter of the culvert, water flow through the culvert was decreased due to frictional drag along the sides of the culvert. Discharge from the culverts tends to decrease with the average head level inside the cell from 15 to 16.5 ft (Fig. 6.18a), but increased with an increase in head difference across the cell from 0 to 0.2 ft (Figure 6.18b).

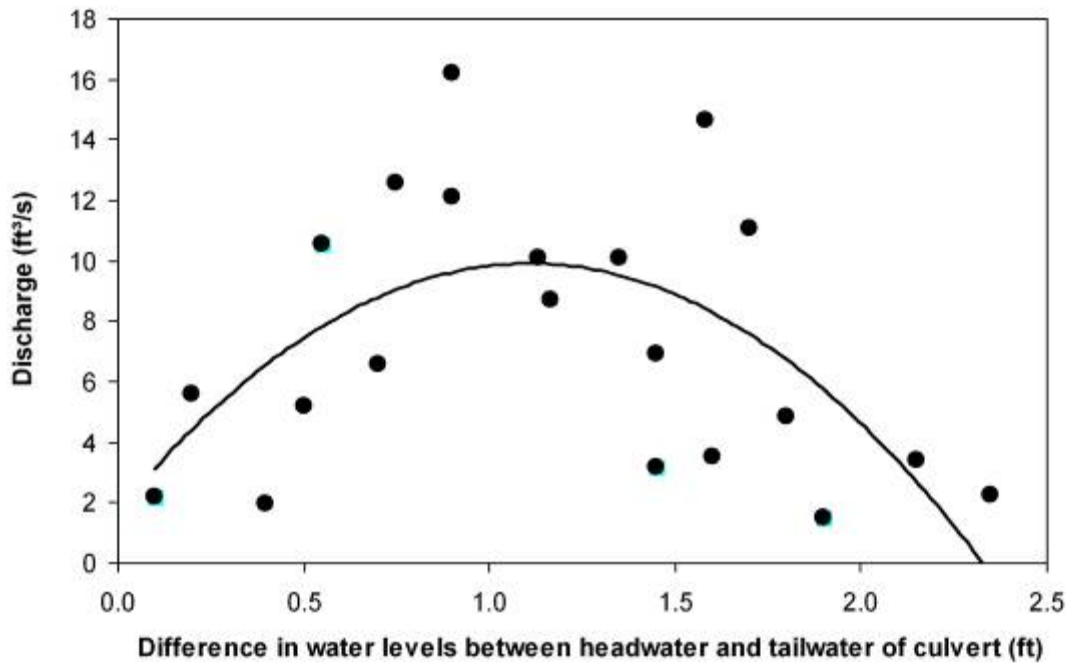

Figure 6.17. Discharge rates measured from culverts under varying water level conditions. Highest discharge through the culverts occurs when there is about a 0.3 +/- 0.05 m (1.0 +/- 0.2 ft) difference in the water levels on either side of the culvert.

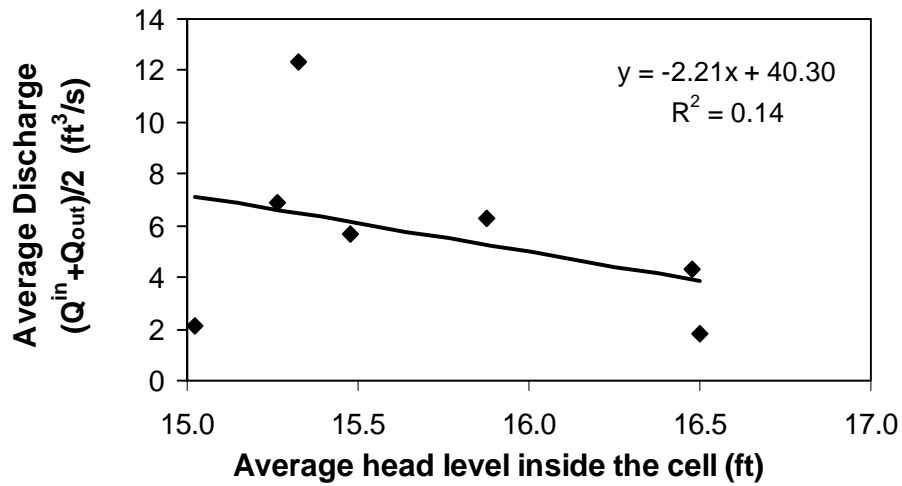

Figure 6.18a Average discharge from the outlet culvert compared with average head level inside of a cell.

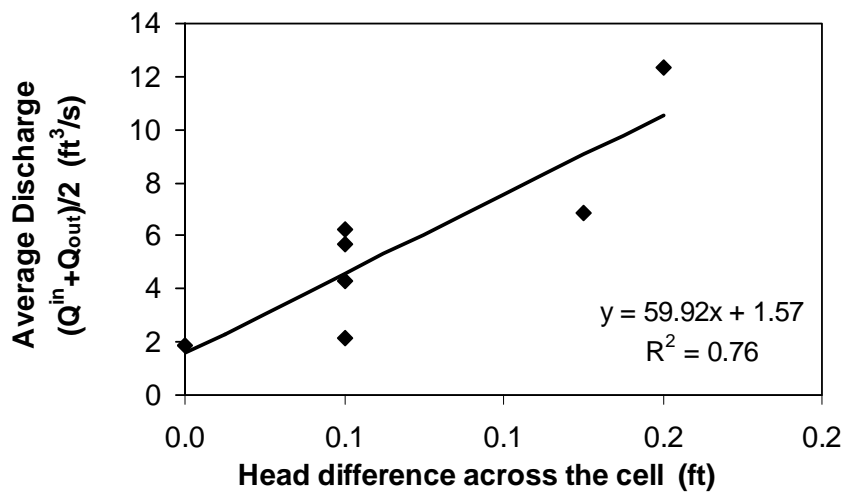

Figure 6.18b. Average discharge from the outlet culvert compared with average head difference across the cell.

6.2.5. Dye Tracer Study

Our initial water velocity measurements made along transects showed that there are regions within LILA macrocosms where flows are reversed or highly diminished as a function of the surrounding levees or vegetation structure or the location of inflow and outflow culverts. This has made it difficult to determine where to locate sentinel velocity meters so as to capture the average hydrologic behavior of each macrocosm. We therefore conducted, with additional financial and logistic support from the SFWMD, an amendment study involving the use of Rhodamine derivative dyes to further assess water flow patterns in the LILA cells (Tasks 4h 1-4).

Cells M1 (non-flowing) and M2 (flowing) were subjected to Rhodamine WT fluorescent dye experiments on October 3, 2007 while Cells M3 (non-flowing) and M4 (flowing) were tested on August 7, 2008. Dyes injected into a flowing body of water behave in the same manner as the water particles within that body of water (Hubbard et al. 1982). Many of the projects proposed in the LILA work plan require water flow as a treatment condition.

M1 and M3 are designated as “non-flowing” meaning that water flow will not be generated within that macrocosm during the life of the LILA project. M2 and M4 are designated as a “flowing” macrocosms; water flow will be generated in these cells utilizing LILA’s water control system. Approximately five gallons of dye was injected into each cell during each of the two studies; in M2 and M4 the dye was injected into the headwaters of the inlet culvert (Fig. 6.2.5.1) to ensure good mixing using a holding tank specifically designed for this purpose (Fig. 6.2.5.2), in M1 and M3 dye was poured in five locations (Fig. 6.2.5.3). Acoustic doppler velocity meters (ADV) capable of measuring sub-centimeter per second flows were stationed within the flowing cells (M2 and M4) in order to quantify flow rates during the dye studies. Six or seven (M4) sample points were designated within each of the flowing cells from which water samples were drawn and analyzed for the concentration of the dye (arbitrary fluorescent units, AFU) using an Aquafluor™ portable fluorometer (Turner Designs, Sunnyvale CA). A series of hourly aerial photos were taken to provide a visual record of the dye’s path and time of travel over the course of the eight hour study.

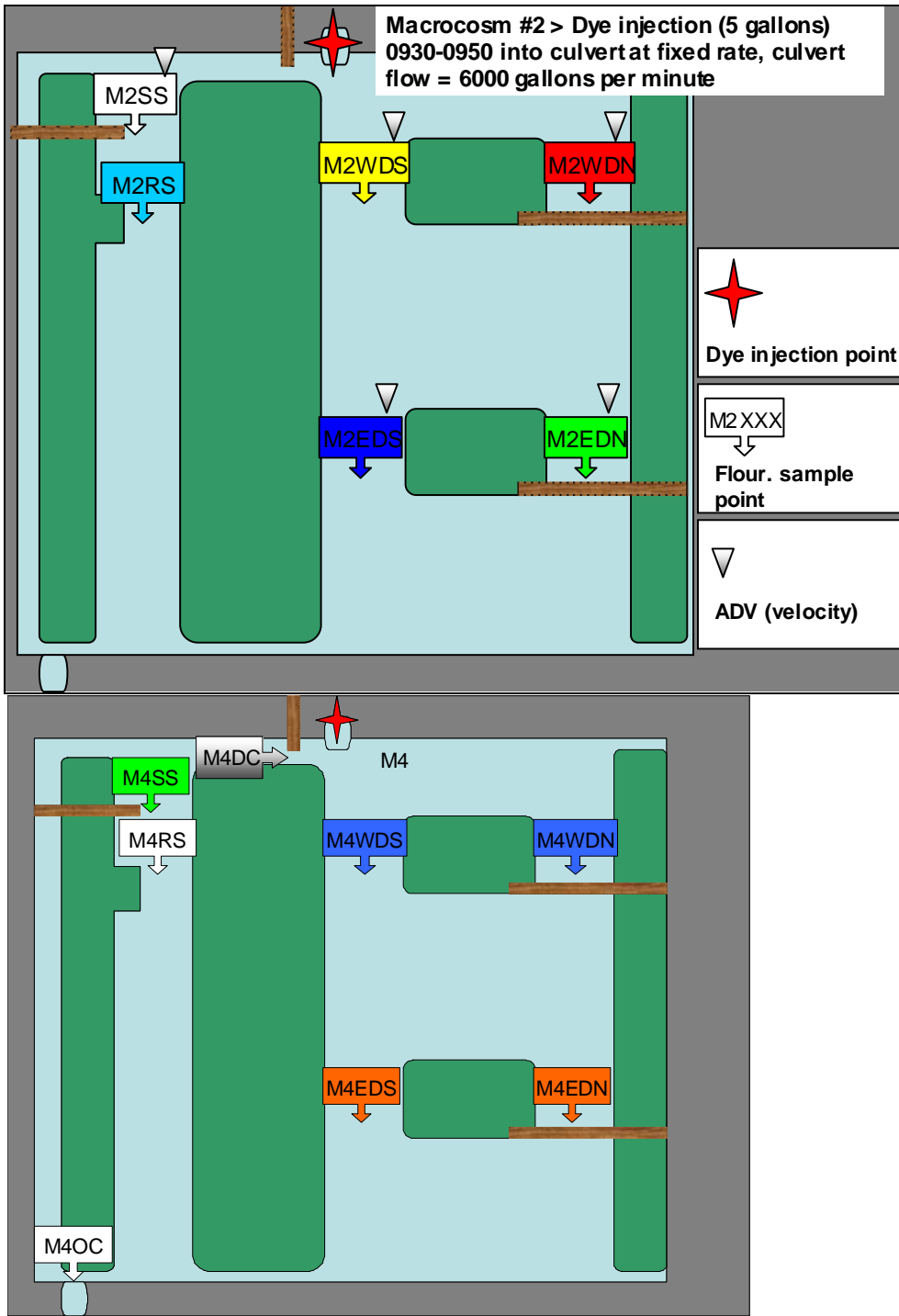

Figure 6.2.5.1. Approximate locations of dye-containing water samples. Dye was fed into the inlet culverts and allowed to move through the cells with time. ADV locations in M4 were similar to those of M2.



Figure. 6.2.5.2. Dye injector - note valve below mixing tank that allows for constant flow.

A visual summary shows that there were distinct differences in water velocity in the flowing vs. the non-flowing cells as expected. This is a main treatment effect of the LILA project and is important to show (Figure 6.2.5.4, using M1 and M2 as examples – similar results were observed in M3 and M4, not shown). Treatments generally behaved similarly in both dye studies. That is, flowing cells showed dye movement while non-flowing cells showed some dispersion with time but no directed downstream movement. The flowing cells M2 and M4 also acted similarly with time (Figure 6.2.5.5) especially in the deep slough and around tree islands. The water level in M4 was at a stage about 6 inches higher than the water level in M2 which seemed to have the greatest effect on the water velocity in the shallow slough where the water seemed to move much further down the shallow slough in M4 vs. M2 (Figure 6.2.5.6). We originally thought that water velocity would more a function of cross channel morphology. That is the smaller volume and shallower depth of the shallow slough would cause relatively greater water velocities. However, it now appears that the vegetation influences flow to a larger extent than does channel depth or width. Additional effects of vegetation density on water flow should be studied.

Hubbard, E.F., Kilpatrick, F.A., Martens, L.A., and Wilson, J.F., Jr. 1982. Measurement of time of travel and dispersion in streams by dye tracing: U.S. Geological Survey Techniques of Water-Resources Investigations, Book 3, Chapter A9, 44 p.

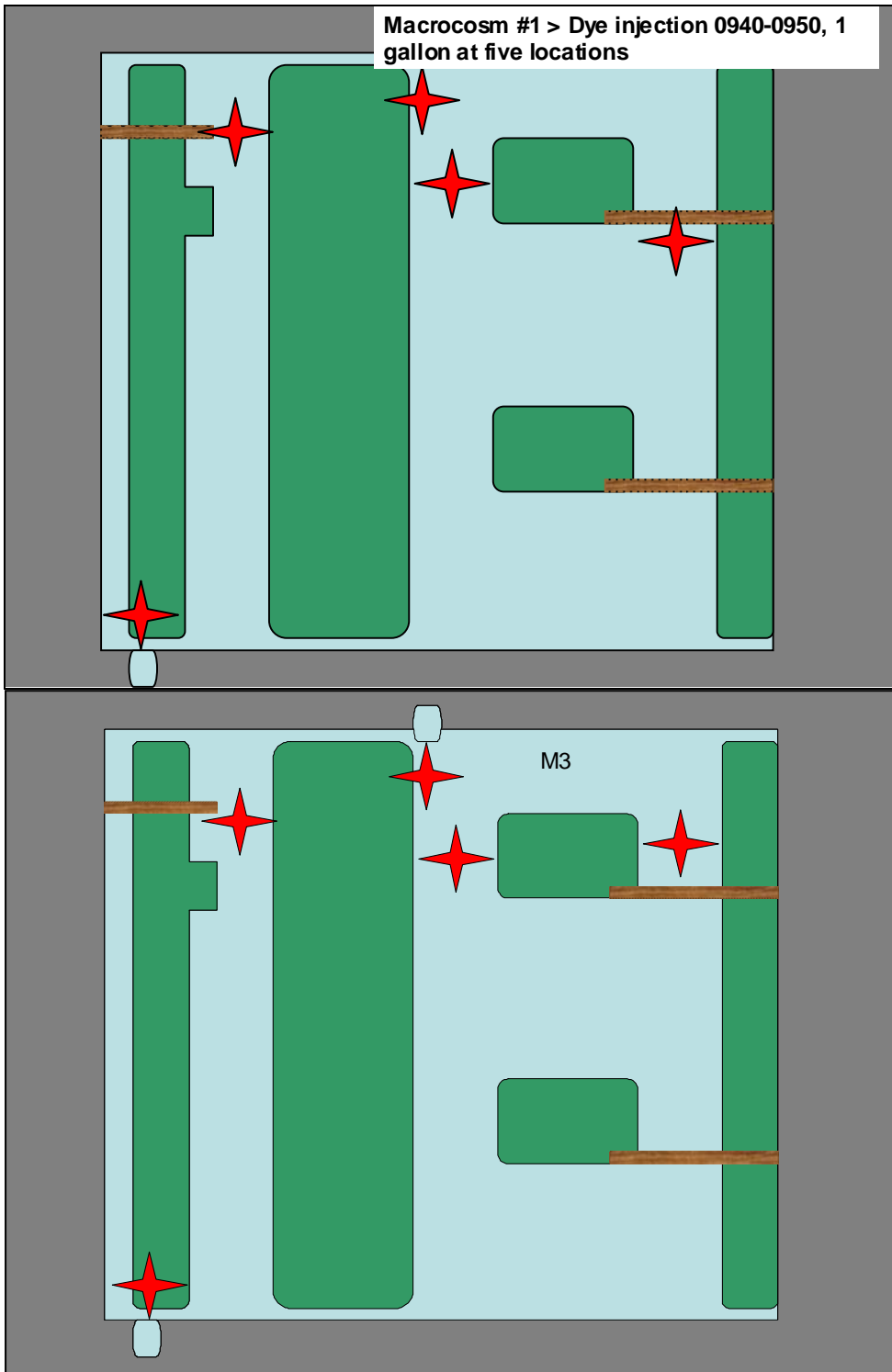

Figure 6.2.5.3. Approximate locations in cells M1 (top) and M3 (bottom) where dye was poured.



Figure 6.2.5.4. Comparison between flowing M2 (top of picture) and non-flowing M1 (lower), 1 hour after dye release.



Figure 6.2.5.5. Photograph showing “similar” behavior in M2 (bottom) at 244 minutes into the dye study and M4 (top) at 224 minutes.

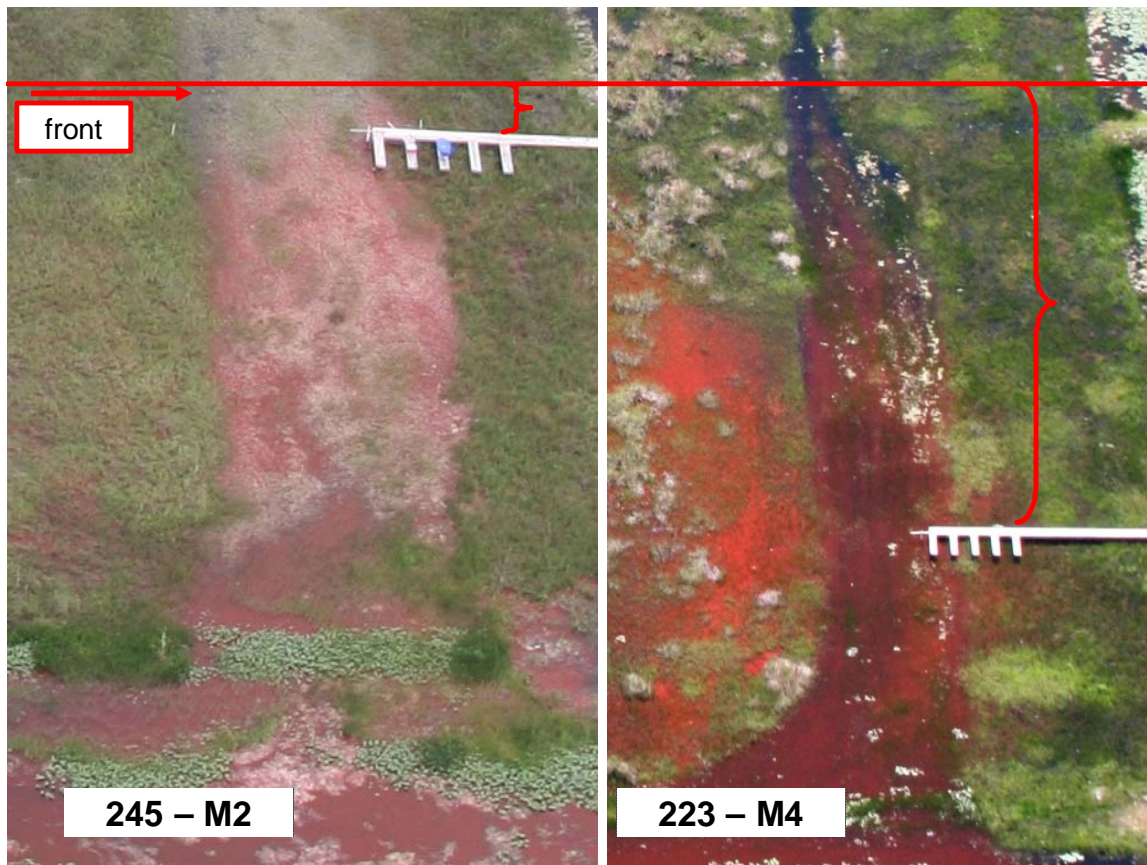

Figure 6.2.5.6. Photograph showing dye location in shallow sloughs of M2 (left) after 245 minutes and M4 (right) after 223 minutes. Note the further distance that dye travelled in M4 within a shorter time. The stage was six inches greater in M4 during dye studies than in M2.

6.3 Groundwater Monitoring

6.3.1 Water Levels

The short-term test of the water levels in all of the wells in the M1 peat island, conducted in September 2006, indicated no clear difference in the water levels along the outside of the tree islands (Figure 6.3.1). When water levels were low (Figure 6.3.1 left), the water table in the center of the tree island was depressed. In that configuration, groundwater flow was from the edges to the center of the tree island. Depressed water level conditions still persisted in the center of the island, during rising water levels (Figure 6.3.1 right). Note that the contours depicted in Figure 6.3.1 include groundwater levels in the well points only, and do not include the surrounding surface water levels.

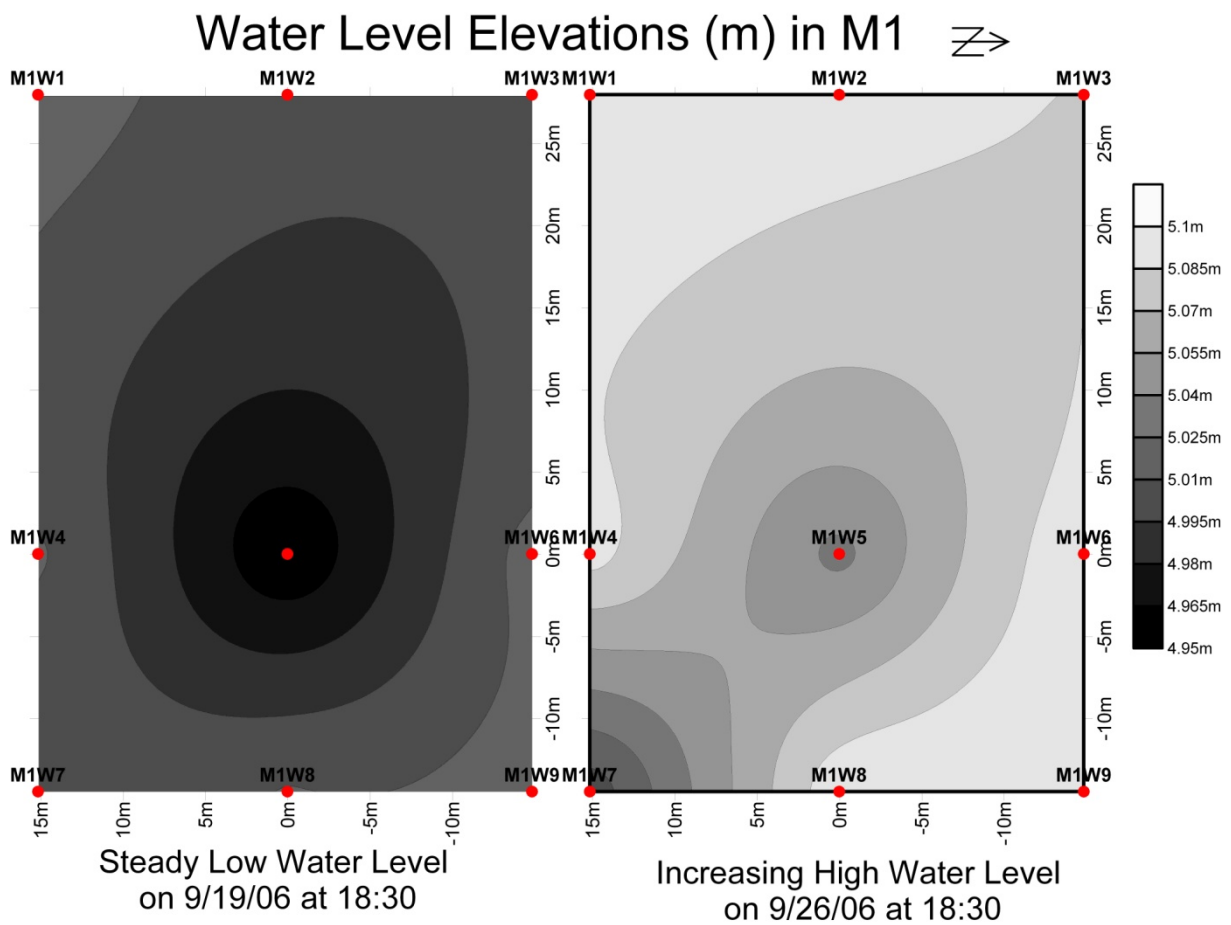

Figure. 6.3.1. Water level contours in tree island M1W as measured in all of the wells during low water levels (left plot) and high water levels (right plot) during September 2006.

Year round the groundwater levels in the center of the peat based islands were on average 8 cm higher than the surface water levels, except for island M3E (Figures 6.3.2, 6.3.3,

6.3.4 and 6.3.5). In addition, the groundwater levels in the limestone core tree islands were on average lower than the surface water levels between the end of December and the June when precipitation inputs were low. The response of the water table to precipitation events varied between tree island type with the largest response detected in the limestone based islands in M1 and M4 and the peat islands in M2 and M3. All of these islands were located near the tail canal. The response of the groundwater levels to precipitation events was greatest during 2006 through Sept. 2008. After Sept. 2008, the response of the groundwater levels to precipitation events was dampened. This dampened response to precipitation events may be due to increased interception of the rain by the trees on the islands as the trees continued to grow.

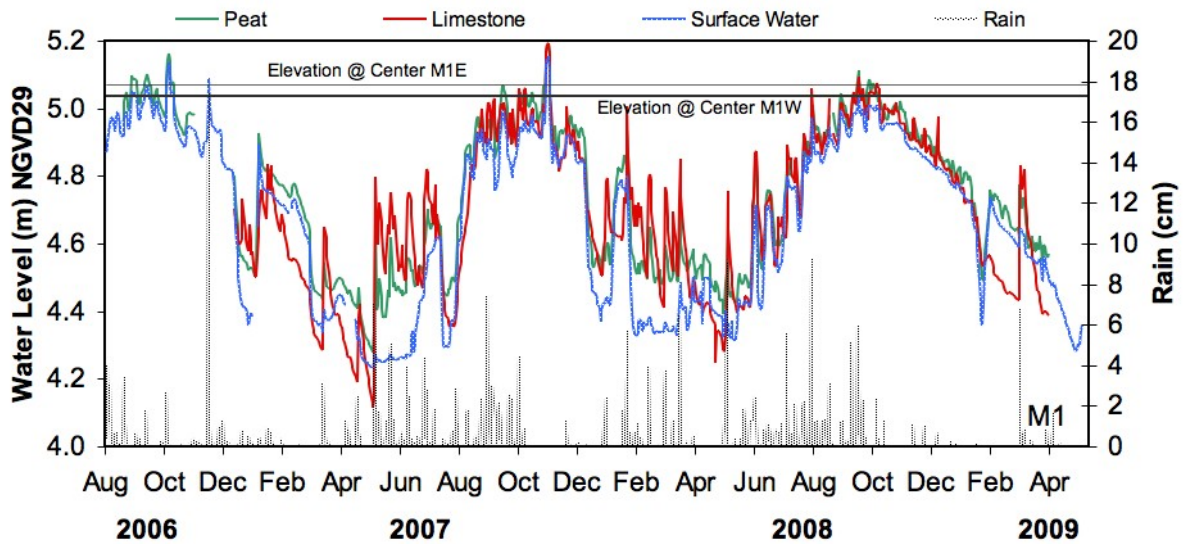

Figure 6.3.2. Daily average surface water levels (blue) and hourly average groundwater level for the center of the peat (green) and limestone (red) based tree islands in M1 from September 2006 to May 2009.

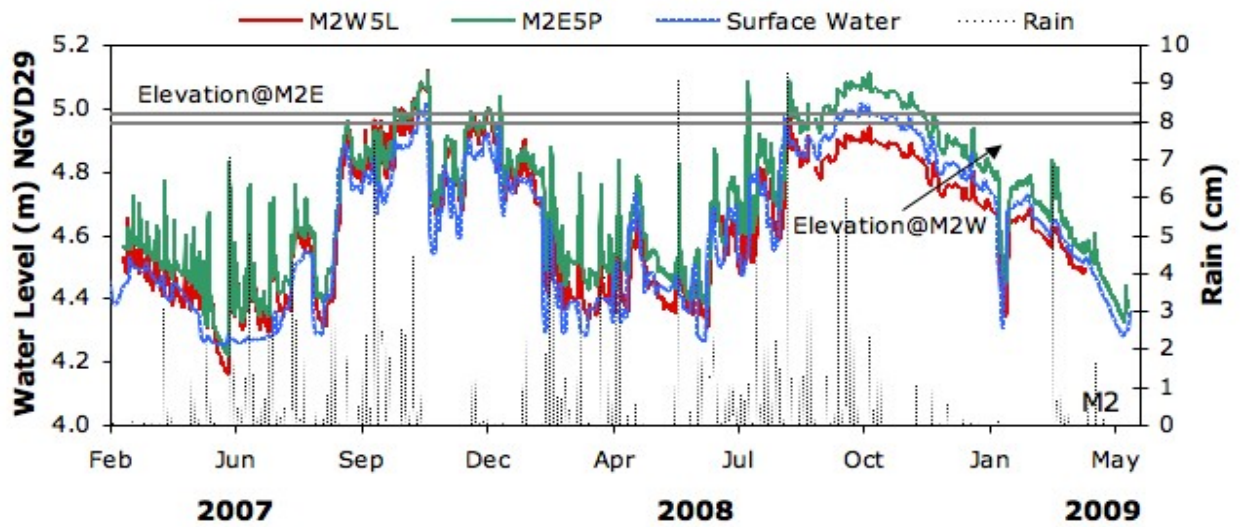

Figure 6.3.3. Daily average surface water levels (blue) and hourly average groundwater level for the center of the peat (green) and limestone (red) based tree islands in M2 from February 2007 to May 2009.

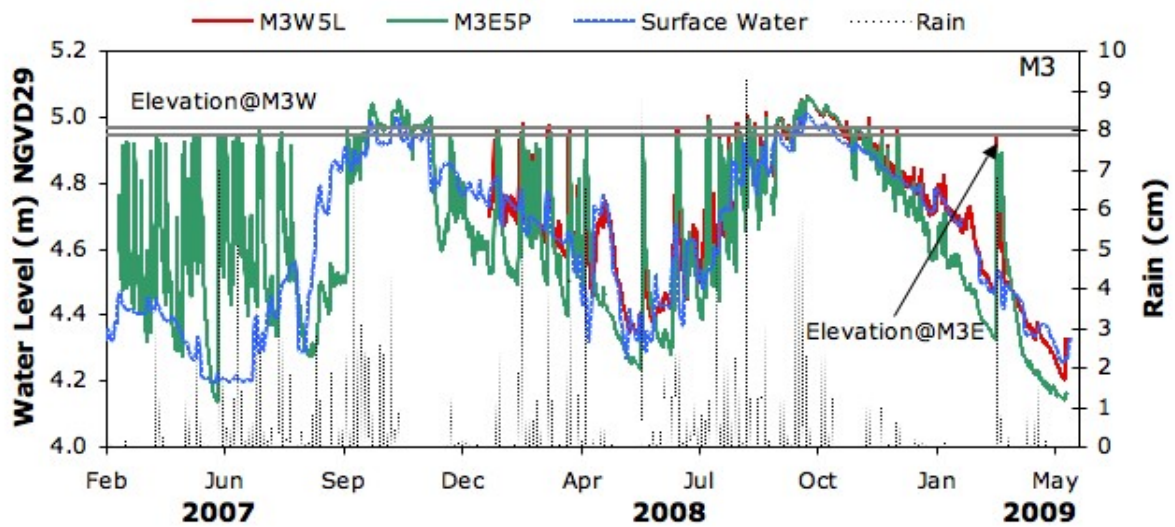

Figure 6.3.4. Daily average surface water levels (blue) and hourly average groundwater level for the center of the peat (green) and limestone (red) based tree islands in M3 from February 2007 to May 2009.

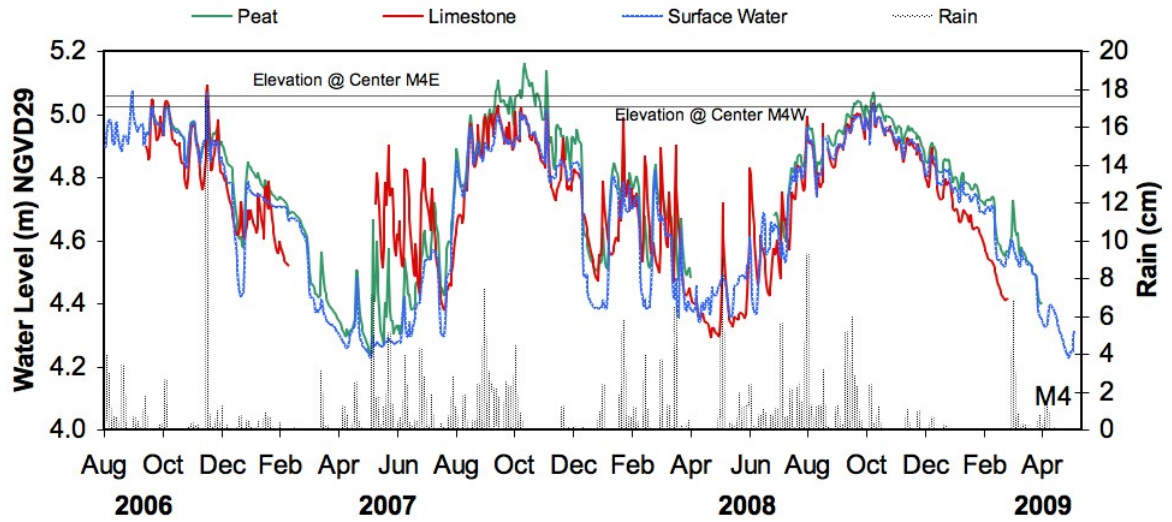

Figure 6.3.5. Daily average surface water levels (blue) and hourly average groundwater level for the center of the peat (green) and limestone (red) based tree islands in M3 from August 2006 to May 2009.

6.3.2. Temperature

6.3.2.1 Groundwater in the Center of Islands

The groundwater temperature in the center of the peat and limestone based tree islands varied between 20.9 °C and 28.8 °C with an average of 24.8 °C (Figures 6.3.2.1.1-4). In general, there was a 1-1.5 °C difference between the peat and limestone based islands in each macrocosm from November to March and June to September. Typically the limestone base tree islands had cooler groundwater temperatures from November to March as compared to the peat based island. Conversely, from June to September the groundwater temperature in the center of the limestone islands is warm as compared to the peat islands. The islands in M3 did not exhibit this same seasonal relationship between temperature and island substrate, instead the groundwater temperature in the center of both islands were almost the same.

6.3.2.2. Surface Water Transects

In general, the average surface water temperature at a distance of 4 m and 8 m from the M1E tree island was about 0.5-1.0 °C cooler than that surface water at 12 m, 16m, and 20m between February 17th 2009 and April 6th 2009 (Figure 6.3.2.3a). In addition, the average daily surface water temperature adjacent to M2E at a distance of 8 m fell between the average surface water temperatures at all other locations and the groundwater temperature in the slough between February and mid March (Figure 6.3.2.3b). At the beginning of May when surface water levels were very low, the surface water temperatures adjacent to M2E became stratified with the coolest surface water temperatures at 4 m and the warmest surface water temperatures at 16 m and 20 m (Figure 6.3.2.3b). When the surface water temperatures were compared to the groundwater temperatures in the sloughs, and edge and center of the tree islands, the groundwater temperature in the sloughs was more similar to the surface water temperatures as compared to the groundwater in the edge or center of the islands. Groundwater temperatures measured at the edge of the tree islands were monitored under a separate contract between FIU and the SFWMD (PO #4500013487).

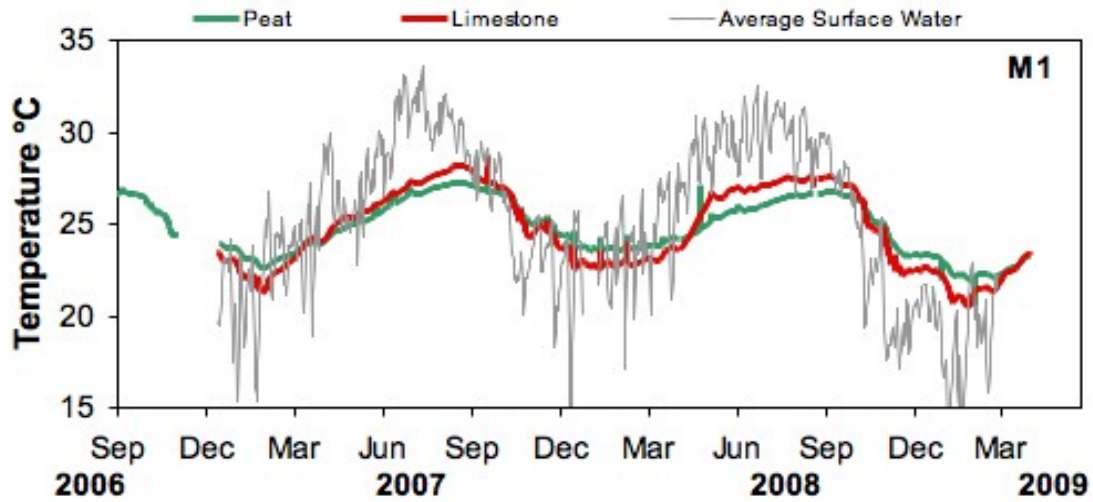

Figure 6.3.2.1.1. Daily average surface water temperature (gray) and hourly average groundwater temperature for the center of the peat (green) and limestone (red) based tree islands in macrocosm 1 from September 2006 to March 2009.

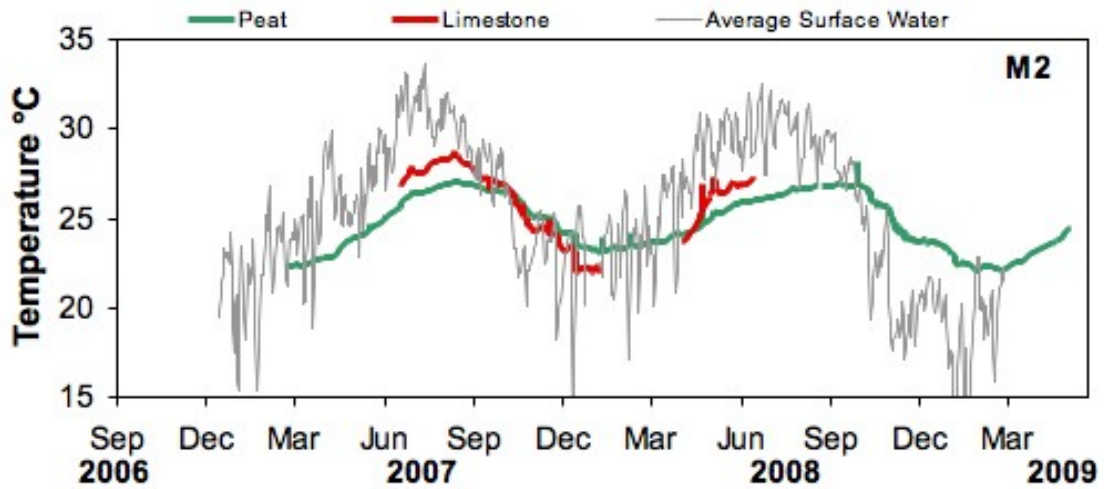

Figure 6.3.2.1.2. Daily average surface water temperature (gray) and hourly average groundwater temperature for the center of the peat (green) and limestone (red) based tree islands in macrocosm 2 from September 2006 to March 2009.

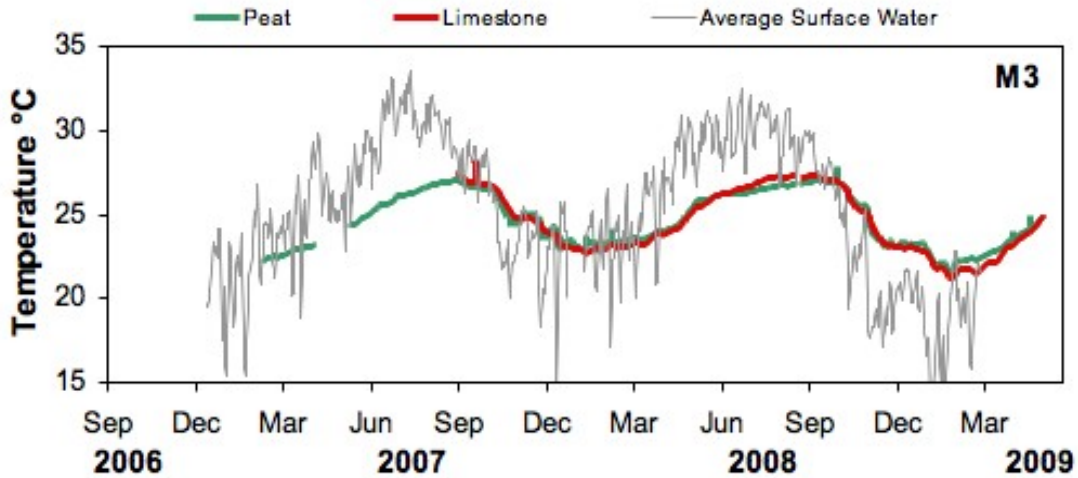

Figure 6.3.2.1.3. Daily average surface water temperature (gray) and hourly average groundwater temperature for the center of the peat (green) and limestone (red) based tree islands in macrocosm 3 from September 2006 to March 2009.

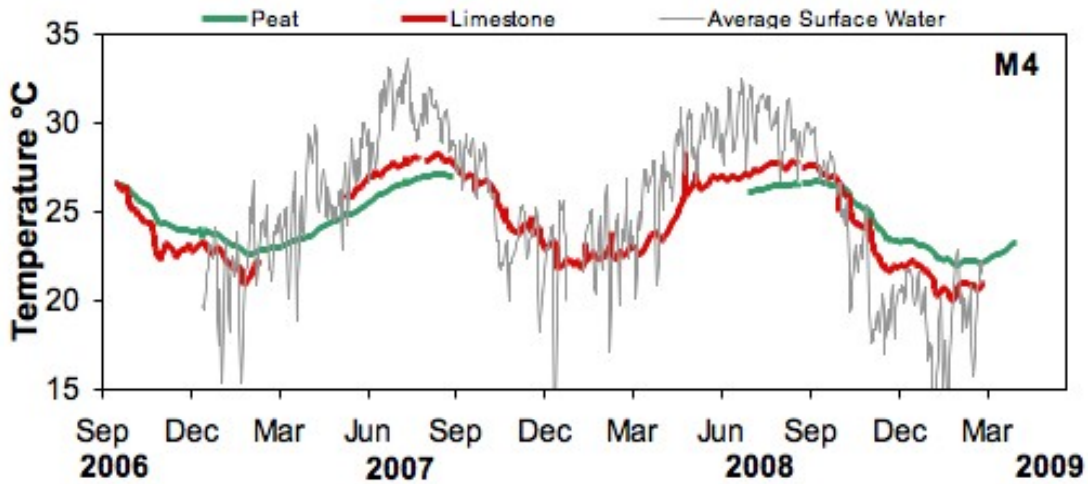

Figure 6.3.2.1.4. Daily average surface water temperature (gray) and hourly average groundwater temperature for the center of the peat (green) and limestone (red) based tree islands in macrocosm 4 from September 2006 to March 2009.

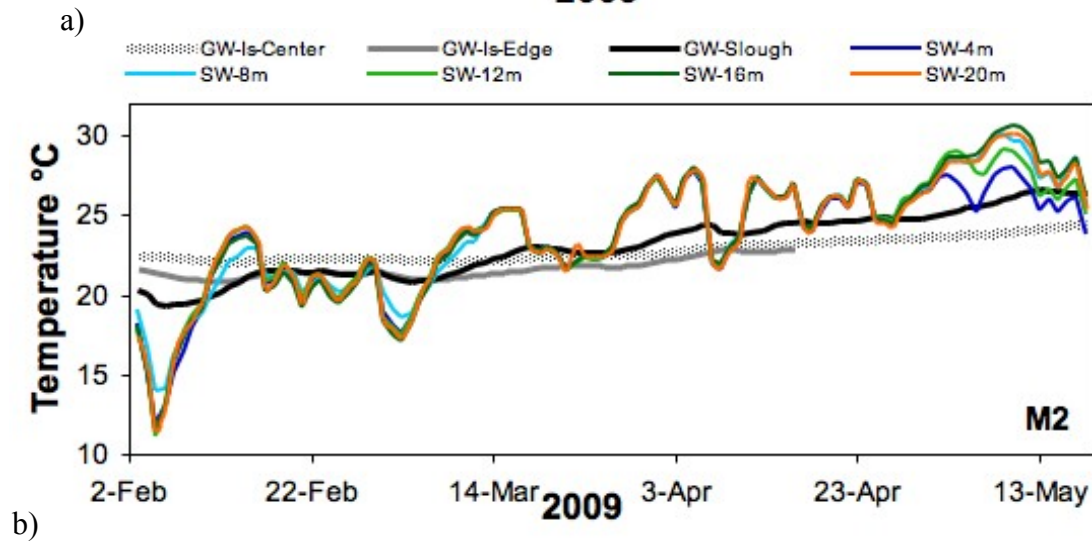
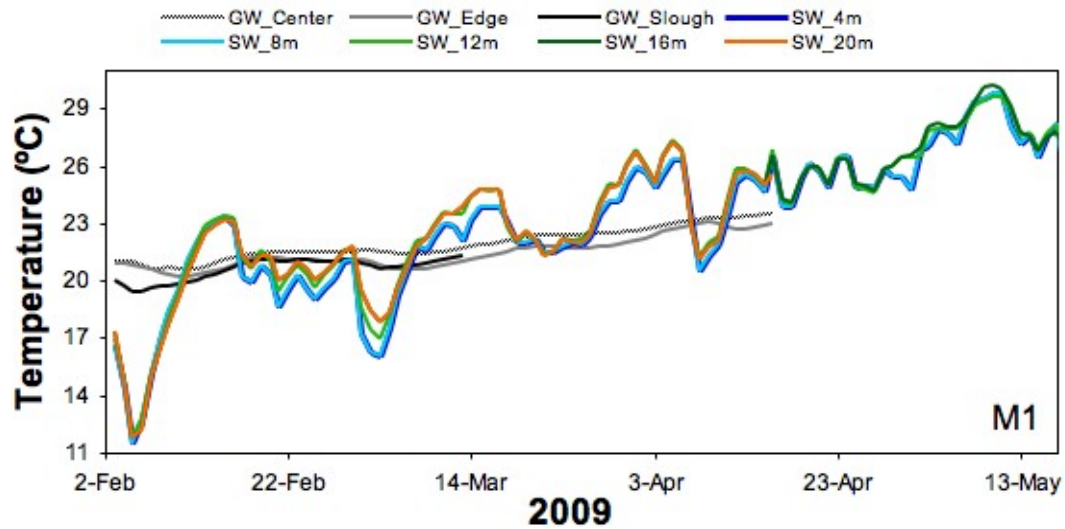

Figure 6.3.2.3.1. The average surface water temperature (colored lines) in the slough adjacent tree islands a) M1E and b) M2E, each measurement is taken 4m increments from the islands edge. Groundwater temperatures from the center (light gray) and edge (dark gray) of the tree islands, as well as the slough (black) help to indicate groundwater surface water interactions.

Task 4 Deliverables included the installation of stage recorders (4a) and the purchase and installation of well points in all 4 cells (4b and d). This equipment was then used for continuous water level monitoring; a summary of which has been included here and in each of the previous annual reports (4 b, c, d, e, f, and g). Task 4c required that initial velocity transects be conducted. Results of these experiments showed that they would not be adequate to characterize the complex flow patterns of LILA. Therefore, Task 4e, Final Velocity was not done by the transect method but rather was done by conducting dye studies in all four cells. This change in approach was done with consultation, agreement, and an amended contract with the SFWMD thus satisfying Tasks 4e (amended) and Tasks 4h (1-4). Finally, Task 4k required the installation of water temperature loggers which was completed (see section 6.1.3 above). A letter report was required after the installation of the temperature loggers which was submitted and accepted by the SFWMD in July 2009. Therefore all deliverables associated with Task 4 have been accomplished. In addition to contracted deliverables we, in concert with SFWMD staff and scientists, have expended time and energy developing an operational hydrograph, working on culvert settings and velocity measures, and installing and monitoring a weather station, all for the purpose of more adequately understanding the hydrology of LILA.

7. Task 5. Vegetation Studies

This section as presented is in preparation for publication and therefore does not follow the conventions of the previous sections.

The present vegetation studies report is arranged in three sections. Section 1 describes tree survival and growth in response to hydrology and different substrate types over the first 30 months of the FIU LILA study (March 2006 to September 2008) in cells M1 and M4. This section will be submitted for publication in a peer-reviewed journal later this summer. In Section 2, we present a complete analysis of tree survival and growth analysis through the most recent sampling event (March 2009). Section 2 is divided into two subsections, the first extending M1 and M4 responses from 30 to 36 months post-planting, and the second describing tree responses in Macrocosms M2 and M3 through 24 months of outplanting. Finally, section three summarizes the habitat analysis of other vegetation on the tree islands. Once tree were established this vegetation was controlled by several techniques to insure tree seedling survival.

Section 1

Survival and growth responses of eight Everglades tree species along an experimental hydrologic gradient on two tree island types

Introduction

In the broadest sense, tree islands are clumps of woody vegetation embedded in a matrix of contrasting vegetation type (Tomlinson 1980). However, most often the term has been applied where the surrounding matrix is freshwater marsh, in places like the Florida Everglades (Wetzel et al. 2005), the Okavango Delta (Gumbrecht et al. 2004), and the Pantanal of Brazil (Prance & Schaller 1982). Tree islands in these ecosystems occupy modestly elevated locations in slightly inclined, flooded landscapes over which surface water has flowed slowly in a consistent direction for centuries, at least prior to any human modification of the hydrologic regime. The presence of tree islands in such systems, despite divergent climatic and sedimentary conditions, raises questions about common biological and physical mechanisms in their formation and maintenance (Wetzel 2002a). During the early stages of tree island development, facilitative processes by which biological agents, e.g., nurse trees (Duarte et al. 2006) or termitaria (McCarthy et al. 1998) serve as nucleation sites may be critical. Later in development the roles of animals as seed or nutrient vectors (Givnish et al. 2007) can also be important in maintaining tree island function in the landscape. Concurrently, the biogeochemistry of the rooting environment, which emerges from the interaction of substrate with local hydrology, exerts an overriding influence on tree growth and forest composition. Hydrologic conditions can influence chemical and physical properties such as nutrient availability, degree of substrate anoxia, sediment properties, and pH (Mitsch & Gosselink 2007) which in turn have a direct impact on wetland plants. Experiments have demonstrated that competition from neighbors of similar or different growth form can exert a significant influence upon plant performance (Keddy 2000), as

the growth of individuals rises toward limits imposed by their own physiology when competition is reduced.

Among the most distinctive features of the Everglades landscape, tree islands were described in some detail by early explorers, naturalists, and ecologists (e.g., Willoughby 1898; Harshberger 1914, Harper 1927). Tree islands can form on flat limestone surfaces, or above depressions or outcrops in the bedrock, but in most cases soil-forming processes cause surfaces to build up tens or hundreds of centimeters above the surrounding terrain. Several modes of tree island formation have been noted. Battery islands, common in the Loxahatchee National Wildlife Refuge, form when a large peat mat detaches and rafts downstream, finally attaching to form a local high point favorable to colonization by woody plants. In most of the Everglades, however, tree islands form in place, in edaphic and physiographic settings that somehow favor woody plant establishment and survival. Once formed, accretionary processes within the tree islands modify the substrate on which they became established. Everglades tree island soils display high variability, with sediments in the center of the drainage and along its immediate flanks ranging from nearly pure peats to highly calcareous mucks.

Sharp declines in the number and area of tree islands have been reported for some portions of the Everglades (Hofmockel et al. 2008, Wetzel 2005). Tree island loss has generally been attributed to management-related changes in hydrologic regime, either prolonged periods of high water, which can cause death in all but the most flood-tolerant woody species, or excessively dry conditions, which increase the likelihood of catastrophic peat fires. Of course, less dramatic hydrologic influences, for instance impacts on stand composition or forest productivity, are pervasive. Several studies have described the hydrologic affinities of woody species common to Everglades tree islands, based on their field distributions (Armentano et al. 2002; Wetzel 2002b) or their performance under experimental conditions (Gunderson 1988; Jones et al. 2006). One element absent from the above studies was an explicit consideration of the underlying soils, which may shape species responses to hydrology through their capacities to store water or nutrients, or to supply them to plants. More recently, van der Valk et al. (2007) tested the effect of elevation and substrate on seedling survival and growth in a field experiment.

In 2006, we established mixed tree communities on artificially created islands in the Loxahatchee Impoundment Landscape Assessment (LILA) site, where van der Valk and colleagues (2007) had performed their earlier experiment. LILA's replicated design and controlled hydrology allowed us to investigate the initial development of these forests in a robust experimental framework. Our research objective was to analyze the effects of hydrology and soils on seedling growth and survivorship during the first 2.5 years of stand development.

Methods

Experimental design

The Loxahatchee Impoundment Landscape Assessment or LILA project is an experimental complex constructed at the Arthur R. Marshall Loxahatchee National Wildlife Refuge (LNWR) in Boynton Beach, Florida. LILA was created through a partnership between the South Florida Water Management District, the U. S. Fish and Wildlife Service and the U. S.

Army Corps of Engineers. LILA consists of four identical, 20-acre “macrocosms” that were established in 2002-2003 from existing LNWR impoundments. In each macrocosm, a landscape comprising the key features of the interior Everglades, i.e., ridges, sloughs and tree islands, was constructed. The hydrology within LILA is managed by a large electric pump (65 cfs), a series of water control structures and recording stage gauges, allowing scientists to manage water levels and flow rates within each macrocosm. LILA serves as a landscape-scale physical model of the Everglades and allows investigators to precisely measure environmental responses to restoration strategies as hydrology and other critical processes are controlled and replicated.

At LILA, tree island construction began in October 2002 and was completed by February 2003. Two islands were constructed in each macrocosm: a peat-based island that mimicked the “battery” islands common in LNWR, and a limestone-core island that represented the “fixed” islands that form around bedrock highs throughout the Everglades (Sklar & van der Valk 2002). Referred to hereafter as peat and limestone islands, both types were 71 x 43 m, with a flat center portion elevated 0.9 m above the surrounding slough surface. Peat islands were constructed wholly from the organic sediments that characterized the pre-construction marshes, while the core of the limestone island consisted of a 14 x 49 m strip of locally-mined limestone along the central axis, capped by 0.3 m of peat. The slopes from the central plateau of both island types were graded to 16:1 along the long north and south sides, and 12:1 along the shorter east and west edges.

The islands were planted initially in 2004, but survival was less than 10% for all but three of the eight planted species, and survivors were harvested after 18 months (van der Valk et al. 2007). By 2006, infrastructural changes allowed for improved planting success. Herbicide applications (glyphosate 2%), followed by prescribed fire, were used to prepare the islands for planting. An irrigation system was installed to mitigate seedling moisture stress during the first three months after planting. Seedlings were watered three times a week during the first month, and twice a week through the remainder of the establishment period. Nuisance vegetation was treated periodically for eighteen months after planting, through a combination of herbicide and manual treatments.

A planting scheme was implemented on each island that included four densities, with trees arranged on 1.00, 1.66, 2.33, and 3.00 m centers. Each quadrant of the plantable area was randomly assigned to one of the four planting densities. Buffers of two meters (E-W direction) or three meters (N-S direction) were retained between density treatments, which provided space for the irrigation system, groundwater wells, and foot traffic. To ensure representative placement in all hydrologic environments, eight species common to Everglades tree islands were randomly assigned to planting locations within the relatively high, interior 18 x 10 m of each quadrant, and the lower surrounding areas separately. Species planted were *Annona glabra*, *Acer rubrum*, *Bursera simaruba*, *Chrysobalanus icaco*, *Ficus aurea*, *Ilex cassine*, *Morella cerifera*, and *Persea palustris*. The planting arrangement called for 89 trees of each species per tree island. Planting stock was from local seed sources, grown for ~9 months in 1-gal pots at a local commercial nursery prior to out-planting in March of 2006 (macrocosms M1 and M4) and 2007 (macrocosms M2 and M3) (Figure 1). In this paper, our analyses focus on the responses of the 2006 cohort.

Survival and total height of each planted seedling was assessed at 2-month intervals during the first year after planting, and subsequently at 6-month intervals. During May-July 2006, new seedlings were replanted at ~50 locations where the originally-planted individual had died soon after planting. Replanted individuals were not included in the survival and growth analyses from the first two years, but were included thereafter.

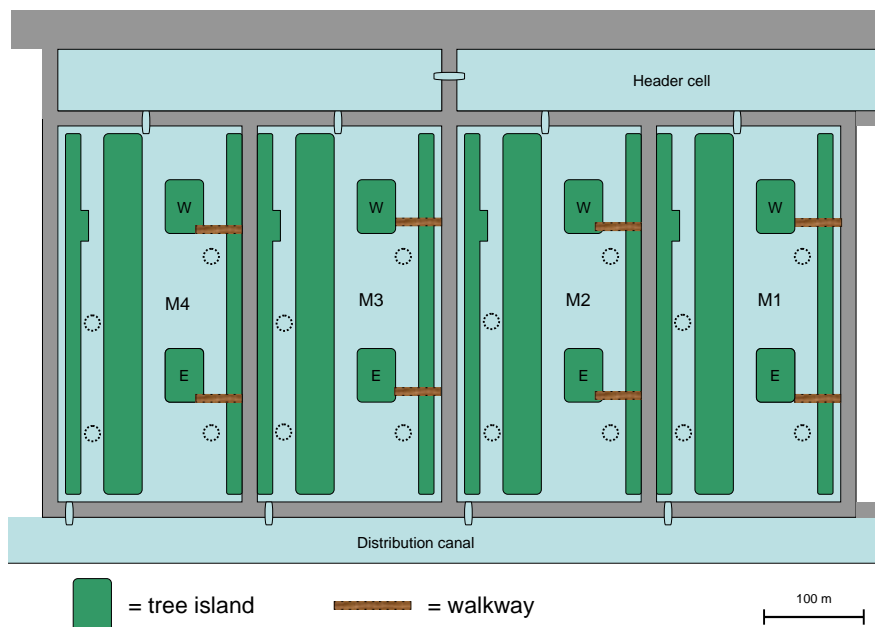

Figure 1: Schematic of the LILA site

Hydrologic and Soil Data

A continuous record of surface and groundwater stage was available for the period May 2007 – August 2008. Surface water level at each island was derived from stage recorders maintained by the SFWMD at the east and west ends of each macrocosm; stages for each tree island were estimated from a linear interpolation between water level at the western (Input) and eastern (Output) ends.

Tree island elevations were established by (1) surveying with an auto-level (3 mm accuracy) from vertical control benchmarks established by the South Florida Water Management District in each macrocosm to a temporary benchmark established in the center of each island, (2) surveying from the temporary benchmark to the base of ~150 newly planted trees of known horizontal location, (3) developing a contour plot of elevation from these data through ARC-GIS 9.2, and (4) applying the Spatial Analyst Extension in ARC-GIS to determine an elevation for each planted tree. Relative Elevation (RE), i.e., cm above or below the mean surface water adjacent to the island over the period May 1st, 2007 to April 30th, 2008, was calculated as an indicator of each tree's position along the hydrologic gradient.

Groundwater monitoring wells were also installed at the center of each island. Wells were

cased at the top with Schedule-40, 3.8 cm diameter PVC pipe, and along the bottom 0.6 m with 0.010 slotted well screen. Mean (\pm s.d.) well depth was 1.34 ± 0.15 m. The top of each well was surveyed from the benchmark established at the center of each island, and groundwater levels were recorded at 15 minute intervals using an In-Situ 500-Troll™ pressure transducer (accuracy ± 3.5 mm) fixed in the well. Two of the pressure transducers (M1E and M4E) failed for short periods of time, which led to a 6% loss in data. Of this lost data, 71% was estimated using a linear regression ($R^2=0.98$) relationship between the data collected in the center well and a nearby well on the same tree island. The groundwater levels were then referenced to interpolated surface water levels. Monthly means of the referenced groundwater levels were calculated for each island. Then the monthly mean of the two center wells were combined to calculate a mean-monthly referenced water level by island type. Surface water levels are managed at LILA to mimic the temporal pattern of surface water in the Everglades, where seasonal precipitation typically causes levels to decline from the end of November to the end of May, then rise from June through November. Precipitation data from a SFWMD weather station in close proximity to LILA was used to correlate large change in groundwater levels and rain events (site: LOX WS).

Data Analysis

The effects of RE and underlying substrate type (peat or limestone) on species survival and growth in height were analyzed through the first two and a half years after planting. The effect of planting density was not examined, because individuals were too small to have interacted meaningfully during at least the early part of the study period. Logistic and linear regressions were applied to explore the effect of RE on cumulative species survival and total height through September 2008, i.e., 2.5 years after planting, in limestone and peat tree islands. ANOVA was used to assess the effect of substrate on species survival and growth. In this case, analysis was restricted to trees planted in the high, flat 14 meter-wide central strip, because this was the only area underlain by limestone in islands of that type. Compliance with the assumptions of least-square regression and ANOVA were examined through normal probability plots of residuals, plots of standard residuals versus predicted values, and plots of standardized residuals against fitted values of independent variables. All analyses were done in Statistica Version 7.1.

Results

Substrate Type

Sediment profiles at the centers of peat and limestone islands are illustrated in Figure 2. Both island types featured a sand unit at 70-80 cm depth, and extended down through at least 1.4 m. The substrate above this unit differed in limestone and peat islands. A peat unit at the surface of the limestone-core islands averaged only 11 cm depth. Below it, the limestone used in construction extended down to the sand layer. In the peat-based islands, a peat substratum extended from the surface to the sand unit.

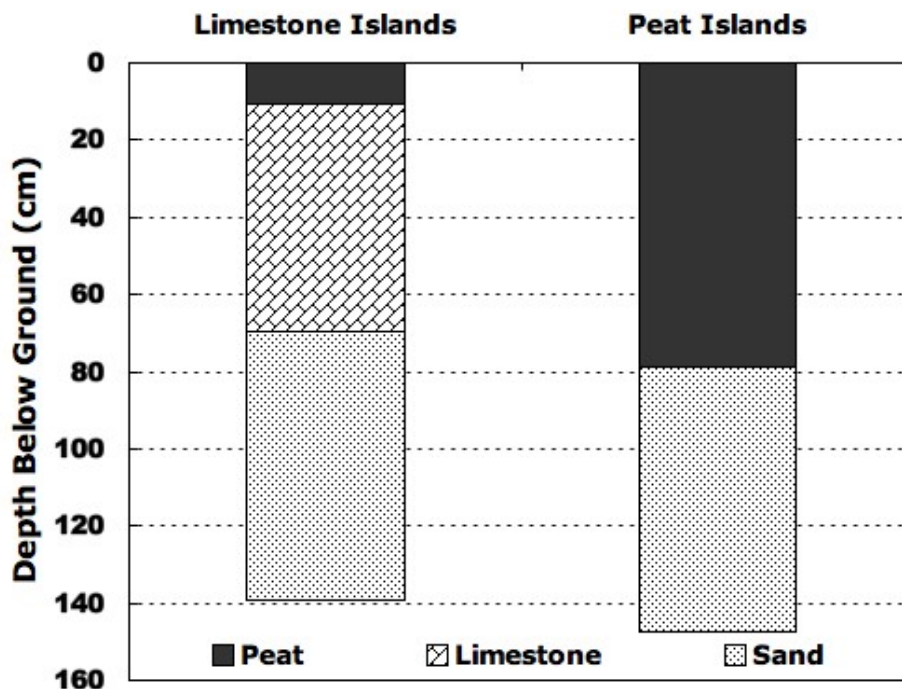

Figure 2. The average below ground depth (m) of sediment detected at the center of the peat and limestone tree islands when the groundwater wells were installed.

Groundwater - Surface Water Interactions

Mean daily surface water level in the adjacent sloughs ranged from 4.29 m to 5.0 m (Figure 3). The high water period of September - January matches the seasonal pattern found in much of the Everglades, as does the low water period of March - July. Several interruptions (in the cycle of flooding and recession (e.g., August 2007, January and March 2008) were operational artifacts of short wildlife experiments at LILA.

During the period of study, groundwater levels in the limestone tree islands had greater within- and among-month variation compared to peat islands. Mean-monthly groundwater levels in the limestone islands varied from 12.7 cm below the surface water to 27.5 cm above it (Figure 3). Mean groundwater levels in the limestone islands were at their lowest compared to surface water in May 2007. This period, which coincided with very low surface water levels and minimal precipitation inputs, was one in which groundwater was recharged by surface water. During the next two months, monthly-mean groundwater levels rose to their highest relative position, more than 20 cm above surface water. Though surface water in June-July 2007 remained low, there was much more input of precipitation, which impacted the direction of groundwater flow and led to groundwater discharging to the surface water (Figure 3). In general, for most of the period of record, the monthly mean groundwater levels in the limestone islands were similar to surface water. Conversely, groundwater levels in peat islands were elevated (by 2.0 - 13.4 cm) relative to surface water year round. From October through December the monthly-mean referenced groundwater levels in the peat based islands were significantly greater than in the limestone islands (Figure 3).

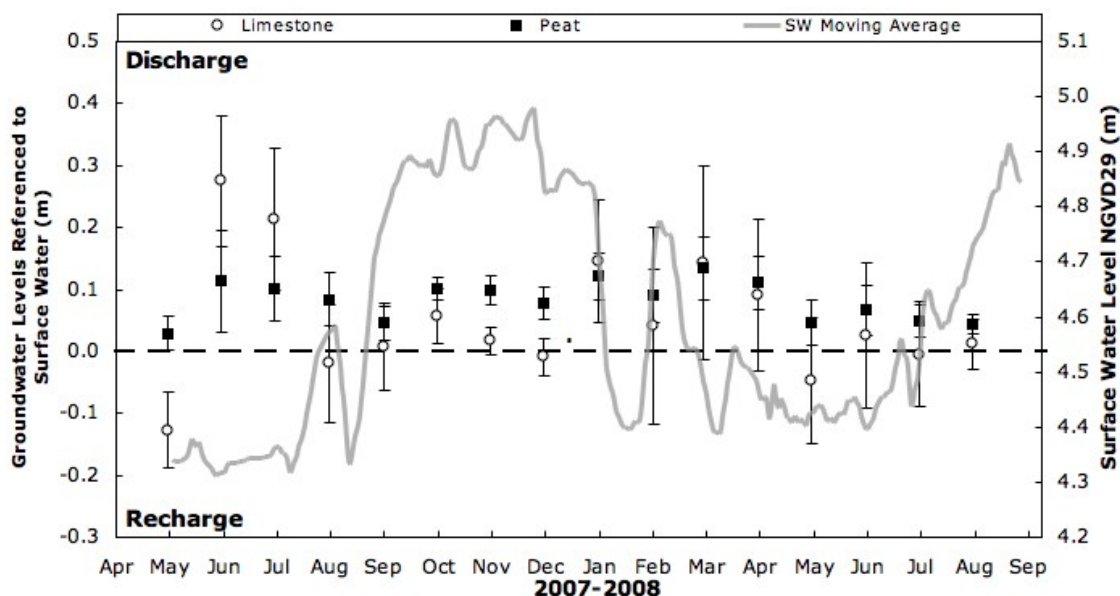

Figure 3. Mean-monthly referenced groundwater levels and standard deviation for the peat (black) and limestone (open) based tree islands compared to the mean daily surface water levels (gray) from May 2007 to August 2008.

Survival

Survival showed a significant response to RE on limestone tree islands where the survival of all species except *A. glabra* increased with increasing RE (Table 1). On peat islands, only *C. icaco* and *P. palustris* showed a survival response to RE. *C. icaco* survival rate decreased as RE increased, while *P. palustris* survival was higher at higher slope positions. Especially on peat islands, the magnitudes of the slope coefficient for the logistic regression models are notable. The highest coefficients were associated with the *B. simaruba*, *P. palustris*, and *F. aurea* models, suggesting the most positive responses to higher slope positions. *M. cerifera*, *C. icaco*, *A. rubrum* and *I. cassine* responses to RE were less marked and *A. glabra* was unaffected. The ranking of these responses roughly approximates the hydrologic niches that these species occupy in the Everglades (e.g., Jones et al. 2006)

Species	Limestone	p-value	Peat	p-value
<i>Annona glabra</i>	0.01	NS	0.0004	NS
<i>Acer rubrum</i>	0.04	<0.05	0.03	NS
<i>Bursera simaruba</i>	0.20	<0.01	-0.0009	NS
<i>Chrysobalanus icaco</i>	0.06	<0.01	-0.02	<0.05
<i>Ficus aurea</i>	0.18	<0.01	0.02	NS
<i>Ilex cassine</i>	0.03	<0.01	0.006	NS
<i>Morella cerifera</i>	0.07	<0.01	0.007	NS
<i>Persea palustris</i>	0.20	<0.01	0.04	<0.01

The dynamics of survival from time of planting through September 2008 is illustrated for limestone and peat tree islands in Figures 4a and 4b. Mortality of many species was concentrated during the spring - summer period (March – September), but was not always equally distributed among islands of the same substrate. For instance, an outbreak of eastern lubber grasshoppers (*Romalea guttata*) in 2006 was responsible for extremely high mortality among newly planted *B. simaruba*, *A. glabra* and *F. aurea* on one peat tree island, but much lower mortality on the second, thereby accounting for the high within-species variability in Figure 4b. High mortality in March-September 2007 was distributed more evenly across tree islands, affecting particularly *Bursera simaruba* and *Ficus aurea* in both limestone (Figure 4a) and peat (Figure 4b) tree islands.

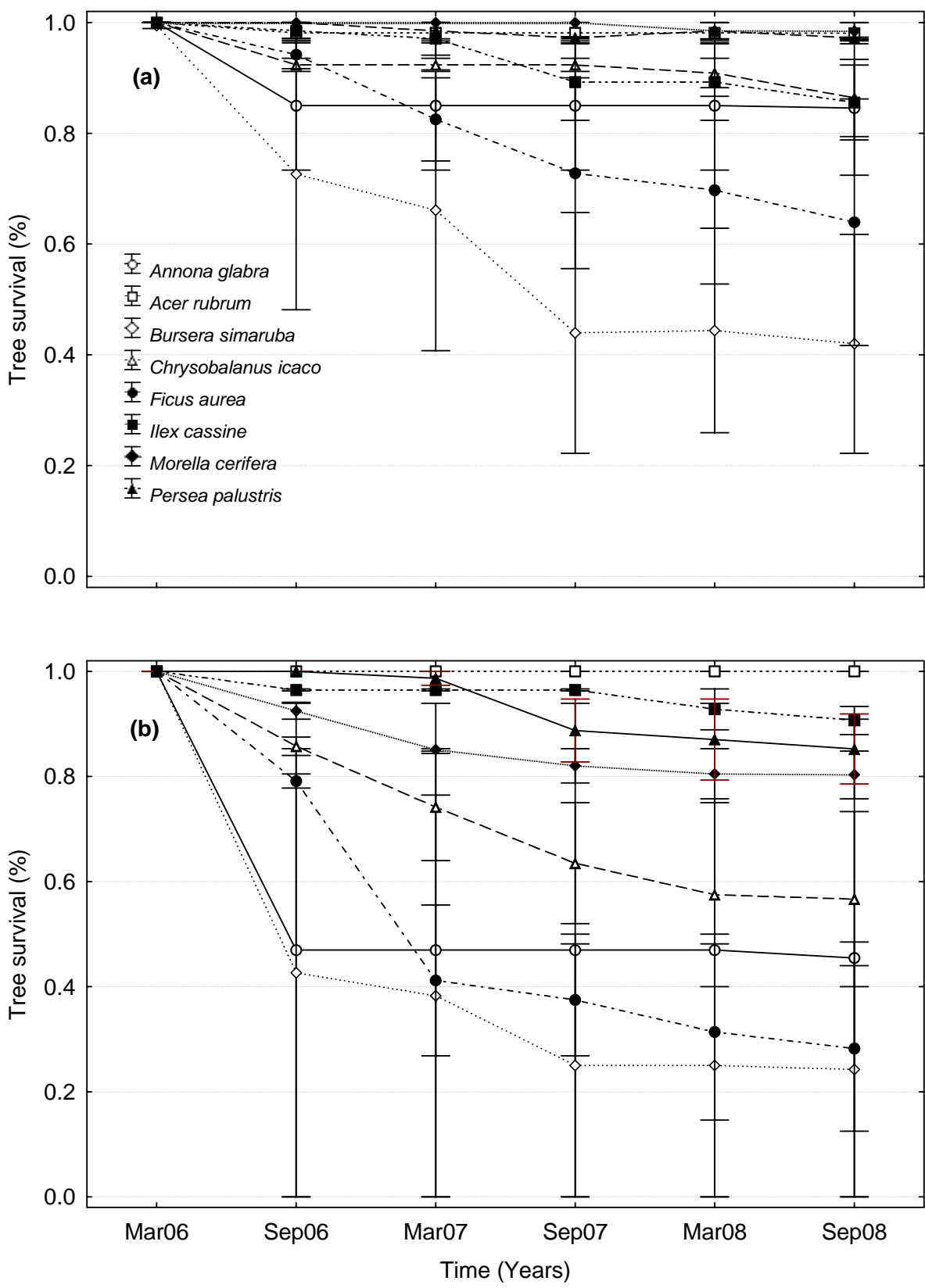

Figure 4: Mean (\pm SE) survival of all tree species in limestone (a) and peat (b) tree islands.

ANOVA results comparing species survival in limestone and peat tree islands through September 2008 are shown in Table 2. All species except *A. rubrum* and *I. cassine* showed significantly higher survival on limestone than peat tree islands.

Species	Limestone	Peat	p
<i>Annona glabra</i>	85	48	<0.01
<i>Acer rubrum</i>	98	100	NS
<i>Bursera simaruba</i>	45	25	<0.05
<i>Chrysobalanus icaco</i>	86	55	<0.01
<i>Ficus aurea</i>	63	24	<0.01
<i>Ilex cassine</i>	85	91	NS
<i>Morella cerifera</i>	98	80	<0.01
<i>Persea palustris</i>	97	86	<0.05

Height growth

The effect of RE on height growth was most pronounced on peat tree islands where six species were taller at higher slope positions (Table 3). *B. simaruba* and *F. aurea*, the two species that did not show a significant response, are typically found on upland sites in the Everglades, and experienced high mortality at LILA, particularly on the peat islands (Figure 4b). Three species exhibited significantly greater height growth on limestone islands, but slope coefficients for all species were lower than on peat islands.

Species	Limestone	p-value	Peat	p-value
<i>Annona glabra</i>	0.19	NS	1.76	<0.01
<i>Acer rubrum</i>	-0.44	NS	1.56	<0.01
<i>Bursera simaruba</i>	-0.25	NS	1.09	NS
<i>Chrysobalanus icaco</i>	1.19	<0.01	1.31	<0.01
<i>Ficus aurea</i>	-1.86	NS	1.36	NS
<i>Ilex cassine</i>	0.65	<0.01	1.16	<0.01
<i>Morella cerifera</i>	1.15	<0.01	2.29	<0.01
<i>Persea palustris</i>	-0.10	NS	1.96	<0.01

Changes in mean height from time of planting to September 2008 are shown for all species across all islands in Figure 5. Since some individuals were eliminated by mortality, these means are not based on precisely the same set of stems, and therefore the progression between sampling periods only approximates growth *per se*. However, the figure demonstrates that tree growth was concentrated in March-September, the season in which most mortality was also experienced (Figure 4).

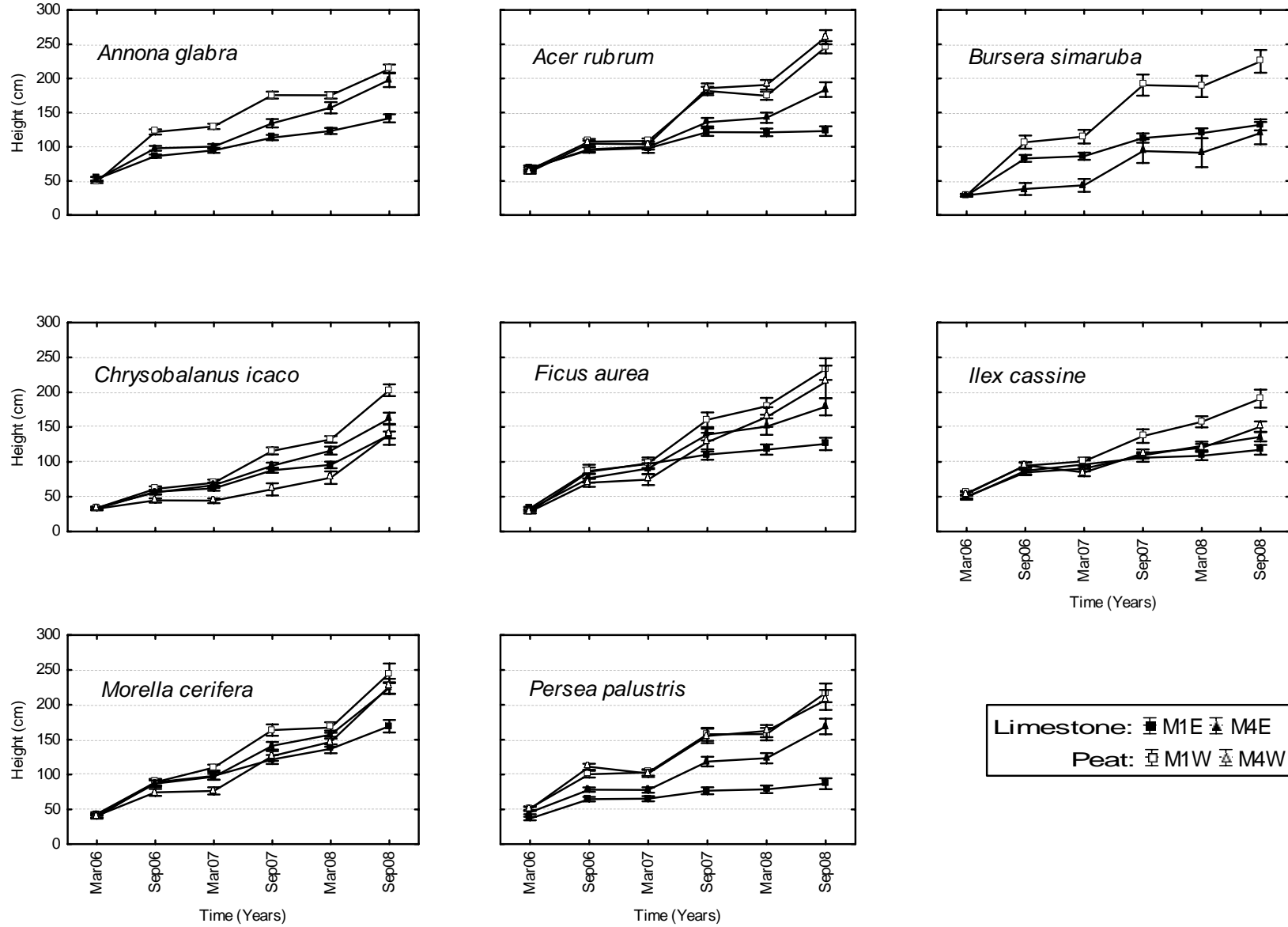

Figure 5. Mean plant height (\pm SE) of eight species in two peat and two limestone tree islands, March 2006-September 2008

The effect of substrate type on the height achieved by individuals during the 2.5 year study period is illustrated in Table 4. All species were significantly taller in peat than in limestone tree islands.

	Limestone	Peat	p
<i>Annona glabra</i>	165	211	<0.01
<i>Acer rubrum</i>	150	253	<0.01
<i>Bursera simaruba</i>	129	225	<0.01
<i>Chrysobalanus icaco</i>	150	183	<0.01
<i>Ficus aurea</i>	160	227	<0.01
<i>Ilex cassine</i>	127	168	<0.01
<i>Morella cerifera</i>	198	236	<0.01
<i>Persea palustris</i>	130	213	<0.01

Discussion

Hydrology has been recognized as the main driver of landscape organization in the Everglades ecosystem through its direct impact on vegetation dynamics and its influence on edaphic patterns and processes (Gunderson 1994). The relationship of hydrology and vegetation is mediated by interactions with dynamic environmental factors, including soil characteristics and disturbance regime (Duever et al. 1986, Olmstead & Armentano 1997). Hydrologic changes have been cited as the primary cause of the reduction in tree island size and number in south Florida, especially in the central and northern Everglades (Wetzel 2005, Hofmockel et al 2008). In response to tree islands loss, many restoration projects have been proposed under the Comprehensive Everglades Restoration Plan framework, spanning from the re-establishment of trees lost to prolonged flooding, fire or exotic invasion, to the wholesale creation of functioning tree islands where they no longer exist. Whatever the goal, restoring tree island communities requires a more comprehensive understanding of the factors that interact with hydrology to shape and maintain ecosystem structure. Critical is the understanding of interactions between hydrology and soil variables, which is fundamental to tree island restoration efforts.

The two types of LILA tree islands represent substrate types common in the Everglades: those comprised purely of peat and those in which predominantly organic soils build up around a central limestone core. At LILA, these two types displayed clear differences in hydrology, driven by the composite effect of their substrates on the local water table, relative to the surface water bathing them on all sides. The peat islands consistently maintained water levels several centimeters above the surrounding surface water, while the water table in the limestone islands, which appeared to be more rapidly drained and flashier in response to large precipitation events, was generally lower and hovered near surface water level. In the latter case, the limestone core presumably provided little capacity to store water, while serving as a near-direct conduit for precipitation to recharge the porous sand unit below. Organic soils such as those present

on the peat islands generally hold more water than mineral soils, and prevent water from passing through rapidly (Mitsch & Gosselink 2007). The result was a higher water table and, very likely, wetter soils within the rooting zones of the planted trees.

On both island types, survival and growth improved with increasing elevations. Flooding is generally the primary stress on bottomland forest tree species of the United States (Mitsch & Rust 1984) as well as on Everglades tree species (Gunderson et al. 1988, Guerra 1997, Jones et al. 2006). Even at the highest elevations at LILA, groundwater rarely dropped more than 0.5 m below the surface, and supplemental irrigation in Year 1 prevented soils from becoming entirely desiccated. However, on high, exposed islands in the Everglades, growth and survival of small seedlings of drought-sensitive species may be limited by drought.

In this study, we were only able to test the effect of substrate on seedling performance at relatively high elevations in the centers of the islands. In these settings, the survival and growth of seedlings growing on the two substrate types differed, but in markedly different directions. In most species, survival was higher on limestone tree islands, while trees were taller on their peat-based counterparts. Both responses may be attributed, directly or indirectly, to contrasting soil moisture conditions. On the droughty upper platform of the limestone islands, water availability was very likely restricted due to lower and more variable groundwater levels, especially during the dry season. Interestingly, these conditions did not have an adverse affect on seedling survival, but instead reduced the cover of competing vegetation. Field observations and aerial photos from the LILA site both clearly demonstrate that the cover of ruderal herbaceous species was considerably less in the centers of limestone tree islands than in similar positions on peat tree islands, resulting in less competition for light. The importance of competition from neighbors in controlling species distributions in wetlands has been demonstrated through experiments (Keddy 2000) and was suggested by van der Valk et al. (2007) as a possible explanation for higher biomass and height of *I. cassine* on limestone cores. Apparently, the chemical and manual weed control applied to prevent competition for light was insufficient to prevent it entirely on the more lush peat tree islands. It is also worth noting that herbivory from lubber grasshoppers was more prevalent on peat tree islands, leading to extensive mortality among selected species. Irrigation probably played a positive role in limestone tree islands by mitigating seedlings moisture stress, but in peat tree islands supplementary water may have created wetter conditions that made seedlings more susceptible to disease (Kozlowski 1984).

Water level data indicate that the groundwater levels in the peat based tree islands remained elevated above the surface water level throughout most of the year. The higher soil moisture content that should result is particularly important from March to September, when most height growth was observed (see Figure 5). In addition, even at the high center of the peat islands, the muted fluctuation in water stage (Figure 3) may lead to equable and well-drained conditions within the rooting zone of trees during late spring droughts. According to Mitsch & Gosselink (2007), such conditions are typically associated with high primary productivity in wetland forests. Besides the direct effect of providing more water for growth, more persistent groundwater inflow could act as a

hydrologic pathway that brings nutrients into the system. Groundwater upwelling has been suggested as a possible way of P transport in Everglades tree islands (Wetzel et al 2005). Even on the young LILA sediments, soil P content in the surface 10 cm was higher in peat (9.01 g/m²) than limestone tree islands (7.33 g/m²) (Scinto pers. comm.).

Most species in the present paper showed a survival increase as RE increased and the degree of flooding tolerance appeared to be reasonably estimated by the slope coefficient of the logistic regression model. Our results mimics species field distribution along natural hydrologic conditions. *F. aurea*, *P. palustris* and *B. simaruba* are more flood-intolerant species typically restricted to the higher parts of tree islands commonly referred as “head”, followed by more flood-tolerant species like, *M. cerifera*, *C. icaco*, *A. rubrum* and *I. cassine* which performed better along the “tail” located downstream the head at lower elevations. Species like *A. glabra* did not show any preference regarding flooding conditions. Several authors have reported similar seedling survival results for matching species although they used different related hydrological measures. Gunderson (1988) ranked *F. aurea*, *C. icaco*, *I. cassine* and *M. cerifera* from least to most tolerant to flooding. Armentano et al. 2002 used data from the distribution of trees along transects from three tree islands in Shark River Slough and water depth from nearby gauging stages to estimate species flooding tolerances. These species were from the least to the most flooding tolerant: *B. simaruba*, *C. icaco*, *P. borbonia*, *F. aurea*, *A. glabra* and *M. cerifera*. Conner et al. (2002) reviewed all the literature published about the flooding tolerances of several species and concluded that *B. simaruba* was the less tolerant, *P. palustris* and *A. rubrum* were moderately tolerant and *A. glabra* the most tolerant to flooding conditions. Jones et al. (2006) ranked the species in order of increasing flood tolerance (increasing water depth): *B. simaruba*, *P. palustris*, *I. cassine*, *C. icaco*, *M. cerifera* and *A. glabra*. Two broad flooding tolerance classes: less flood tolerant (*A. rubrum* and *C. icaco*) and most flood tolerant (*A. glabra*, *I. cassine* and *M. cerifera*) were defined by van der Valk et al. (2007). They also reported about the effect of core type on seedling survival and growth, concluding that there was no effect of core type on survival while growth response was better in limestone than in peat based tree islands for *I. cassine*.

The present study complemented and extended earlier work characterizing survival responses along a soil moisture gradient. In general, quantified responses of seedlings during the first 2.5 years after planting matched species distributions along natural hydrologic conditions in the Everglades. The dependence of species responses to hydrology on soil conditions, particularly their capacity to store water or nutrients, is a major contribution of the present study. This knowledge could have profound implications for the restoration of existing landforms and artificial creation of tree islands. At early stages of development and especially during dry periods, limestone tree islands may provide a more beneficial environment for seedling survival, with less competition than peat tree islands. However, the latter seem to offer better conditions for growth. Nevertheless, both substrate types may be affected by flooding stress so that it becomes critical to anticipate any hydrologic modification in that direction to avoid tree islands loss.

Literature Cited

- Armentano, T.V., Jones, D.T., Ross, M.S. & Gamble, B.W. 2002. Vegetation pattern and process in tree islands of the southern Everglades and adjacent areas. p. 225-282. In: Sklar, F.H. & van der Valk, A. (eds.) *Tree islands of the Everglades*. Kluwer Academic Publishers, Dordrecht, The Netherlands.
- Conner, W.H., Doyle, T.W. & Mason, D.. 2002. Water depth tolerances of dominant tree islands species: what do we know? P. 207-223. In: Sklar, F.H. & van der Valk, A. (eds.) *Tree islands of the Everglades*. Kluwer Academic Publishers, Dordrecht, The Netherlands.
- Duarte, L. DA S., Dos-Santos, M.M.G., Hartz, S.M. & De Patta Pillar, V. 2006. Role of nurse plants in Araucaria forest expansion over grassland in south Brazil. *Austral Ecology* 31: 520-528.
- Duever, M.J., Carlson, J.E., Meeder, J.F., Duever, L.C., Gunderson, L.H., & Riopelle, L.A. 1986. *The Big Cypress National Preserve*. National Audubon Society, New York, USA.
- Givnish, T.J., Volin, J.C., Owen, V.D., Volin, V.C., Muss, J.D. & Glaser, P.H. 2007. Vegetation differentiation in the patterned landscape of the central Everglades: Importance of local and landscape drivers. *Global Ecology and Biogeography*. 17(3):384–402. DOI: 10.1111/j.1466-8238.2007.00371.x
- Guerra, R. 1997. Impacts of the high water period of 1994-95 on tree islands in Water Conservation Areas. p. 47-58. In: Armentano, T. (ed.) *Ecological Assessment of the 1994-1995 High Water Conditions in the Southern Everglades*. South Florida Management and Coordination Working Group, Miami, FL, USA.
- Gumbrecht, T., McCarthy, J. & McCarthy, T.S. 2004. Channels, wetlands and islands in the Okavango Delta, Botswana, and their relation to hydrological and sedimentological processes. *Earth Surface Processes and Landforms* 29: 15-29.
- Gunderson, L.H., Stenberg, J.R. & Herndon, A.K. 1988. Tolerance of five hardwood species to flooding regimes. p. 119-132. In: Wilcox, D.A. (ed.) *Interdisciplinary Approaches to Freshwater Wetlands Research*. Michigan State University Press, East Lansing, MI, USA.
- Gunderson, L.H. 1994. Vegetation of the Everglades: determinants of community composition. In: Davis S.M. & Ogden J.C. (eds.) *Everglades: The Ecosystem and its Restoration*. St. Lucie Press, Boca Raton, pp 323-340.
- Harper, R.M. 1927. Natural resources of southern Florida. Eighteenth Annual Report. Florida State Geological Survey, Tallahassee, FL, USA.

- Harshberger, J.W. 1914. The vegetation of south Florida south of 27° 37' north, exclusive of the Florida Keys. *Transactions of the Wagner Institute of Science of Philadelphia* 7 (3): 51-189.
- Hofmockel, K., Richardson, C.J. & Halpin, P.N. 2008. Effects of Hydrologic Management Decisions on Everglades Tree Islands. p. 191-214. In: Richardson, C.J. (ed.) *The Everglades Experiments: Lessons for Ecosystem Restoration*. Springer, New York,
- Jones, D.T., Sah, J.P., Ross, M.S., Oberbauer, S.F. Hwang, B. & Jayachandran, K. 2006. Responses of twelve tree species common in Everglades tree islands to simulated hydrologic regimes. *Wetlands* 26 (3): 830-844.
- Keddy, P.A. 2000. *Wetland Ecology*. Principles and Conservation. Cambridge University Press.
- McCarthy, T. S., Ellery, W.N. & Dangerfield, J.M. 1998. The role of biota in the initiation and growth of islands on the floodplain of the Okavango alluvial fan, Botswana. *Earth surface Processes and Landforms* 23: 291-316.
- Mitsch, W.J. & Rust, W.G. 1984. Tree growth responses to flooding in a bottomland forest in northeastern Illinois. *Forest Science* 30: 499-510.
- Mitsch, W.J. & Gosselink, J.G. 2007. *Wetlands*. John Wiley & Sons, Inc. 4th Edition. 582 pp.
- Olmstead, I. & Armentano, T.V. 1997. Vegetation of Shark Slough, Everglades National Park. SFNRC Technical Report 97-001. South Florida Natural Resource Center, Everglades National Park, Homestead, Florida, USA.
- Prance, G.T. & Schaller, G.B. 1982. Preliminary study of some vegetation types of the Pantanal, Mato Grosso, Brazil. *Brittonia* 34: 228-251.
- Sklar, F.H. & van der Valk, A. 2002. Tree islands of the Everglades: An overview. p. 1-18. In: Sklar, F.H. & van der Valk, A. (eds.) *Tree islands of the Everglades*. Kluwer Academic Publishers, Dordrecht, The Netherlands.
- StatSoft, Inc. 2006. STATISTICA (data analysis software system), version 7.1. www.statsoft.com.
- Tomlinson, P.B. 1980. *The Biology of Trees Native to Tropical Florida*. Allston, MA: Harvard University Printing Office.

- van der Valk, A.G., Wetzel, P., Cline, E. & Sklar, F.H. 2007. Restoring tree islands in the Everglades: experimental studies of tree seedling survival and growth. *Restoration Ecology* DOI: 10.1111/j.1526-100X.2007.00311.x.
- Wetzel, P.R. 2002a. Tree islands ecosystems of the world. p. 19-69. In: Sklar, F.H. & van der Valk, A. (eds.) *Tree islands of the Everglades*. Kluwer Academic Publishers, Dordrecht, The Netherlands.
- Wetzel, P.R. 2002b. Analysis of tree islands vegetation communities. p. 357-389. In: Sklar, F.H. & van der Valk, A. (eds.) *Tree islands of the Everglades*. Kluwer Academic Publishers, Dordrecht, The Netherlands.
- Wetzel, P.R., van der Valk, A.G., Newman, S., Gawlik, D.E., Gann, T., Coronado-Molina C.A., Childers, D.L. & Sklar, F.H. 2005. Maintaining tree islands in the Florida Everglades: nutrient redistribution is the key. *Frontiers in Ecology and Environment* 3(7): 370-376.
- Willoughby, H.L. 1898. *Across the Everglades: a canoe journey of exploration*. Florida Classics Library, Port Salerno, FL.

Section 2.

Effects of hydrology and substrate types on tree survival and growth over 36 months (March 2006 to March 2009) in cells M1 and M4.

We assessed the survival of each planted seedling, and measured the total height of each survivor at 2-month intervals from March 2006 through March 2007 and at a six-month interval thereafter, i.e., in September 2007, March 2008, September 2008 and March 2009. During May-July 2006, we replanted seedlings at ~60 locations where the planted seedling had died soon after planting. Replanted individuals were not included in the survival and growth analyses from the first two years, but were included thereafter.

Two types of islands were constructed in each macrocosm; one that consisted wholly of peat, and the other with a limestone core. This design is meant to mimic two types of tree islands found in the Everglades system, battery islands and fixed islands. In M1 and M4 the eastern islands had a peat cover underlain by a limestone layer. The western islands consisted entirely of peat. Islands with the limestone unit are herein referred to as limestone based islands while those that consisted of only peat are considered peat based islands.

Relative Elevation (RE) was used as hydrologic variable indicating ground elevation in cm above or below the mean surface water adjacent to the island over the period May 1st, 2007 to April 30th, 2008. Logistic and linear regressions were applied to survival (Table 1) and growth (Table 2) data respectively to describe their relationship with RE in limestone and peat tree islands. We used the equation coefficients for the logistic regression models as metrics by which to rank the effects of RE on survival, and thus to indicate the relative flood tolerances of the eight study species (Table 1). Most of the species showed an increase in survival as RE increased. *P. palustris*, *F. aurea* and *B. simaruba* showed the highest coefficients indicating a much better response to higher slope positions. *M. cerifera*, *C. icaco*, *A. rubrum* and *I. cassine* response to RE was less marked and *A. glabra* was unaffected.

Table 1: Logistic regression coefficients and p-values of Relative Elevation on Survival through September 2009. NS: Not significant				
Species	Limestone	p-value	Peat	p-value
<i>Annona glabra</i>	0.01	NS	0.0004	NS
<i>Acer rubrum</i>	0.04	<0.05	0.03	NS
<i>Bursera simaruba</i>	0.20	<0.01	0.004	NS
<i>Chrysobalanus icaco</i>	0.06	<0.01	-0.02	<0.05
<i>Ficus aurea</i>	0.17	<0.01	0.02	NS
<i>Ilex cassine</i>	0.04	<0.01	0.005	NS
<i>Morella cerifera</i>	0.06	<0.01	0.008	NS
<i>Persea palustris</i>	0.20	<0.01	0.04	<0.01

Relative Elevation had a significant effect on height growth mainly on peat tree islands where most of the species were taller at higher slope positions (Table 2).

Species	Limestone	p-value	Peat	p-value
<i>Annona glabra</i>	0.40	NS	1.76	<0.01
<i>Acer rubrum</i>	-0.40	NS	1.74	<0.01
<i>Bursera simaruba</i>	-0.40	NS	0.54	NS
<i>Chrysobalanus icaco</i>	1.67	<0.01	1.60	<0.01
<i>Ficus aurea</i>	-2.28	NS	1.23	NS
<i>Ilex cassine</i>	0.80	<0.01	1.37	<0.01
<i>Morella cerifera</i>	1.46	<0.01	2.19	<0.01
<i>Persea palustris</i>	0.15	NS	2.18	<0.01

Changes in survival from time of planting to March 2009 is shown for all species in limestone (Figure 1a) and peat tree islands (Figure 1b). The first mortality episode occurred during the first six months after planting (March to September 2006) and was mainly due to an outbreak of eastern lubber grasshoppers (*Romalea guttata*) which was responsible for extremely high mortality among newly planted *B. simaruba*, *A. glabra* and *F. aurea* on one peat tree islands (M4W), but mortality was far less substantial on the second (M1W), thereby accounting for high within-species variability in Figure 1b. High mortality in March-September 2007 was distributed more evenly across tree islands, affecting mainly *Bursera simaruba*, and *Ficus aurea*, in both limestone (Figure 1a) and peat (Figure 1b) tree islands.

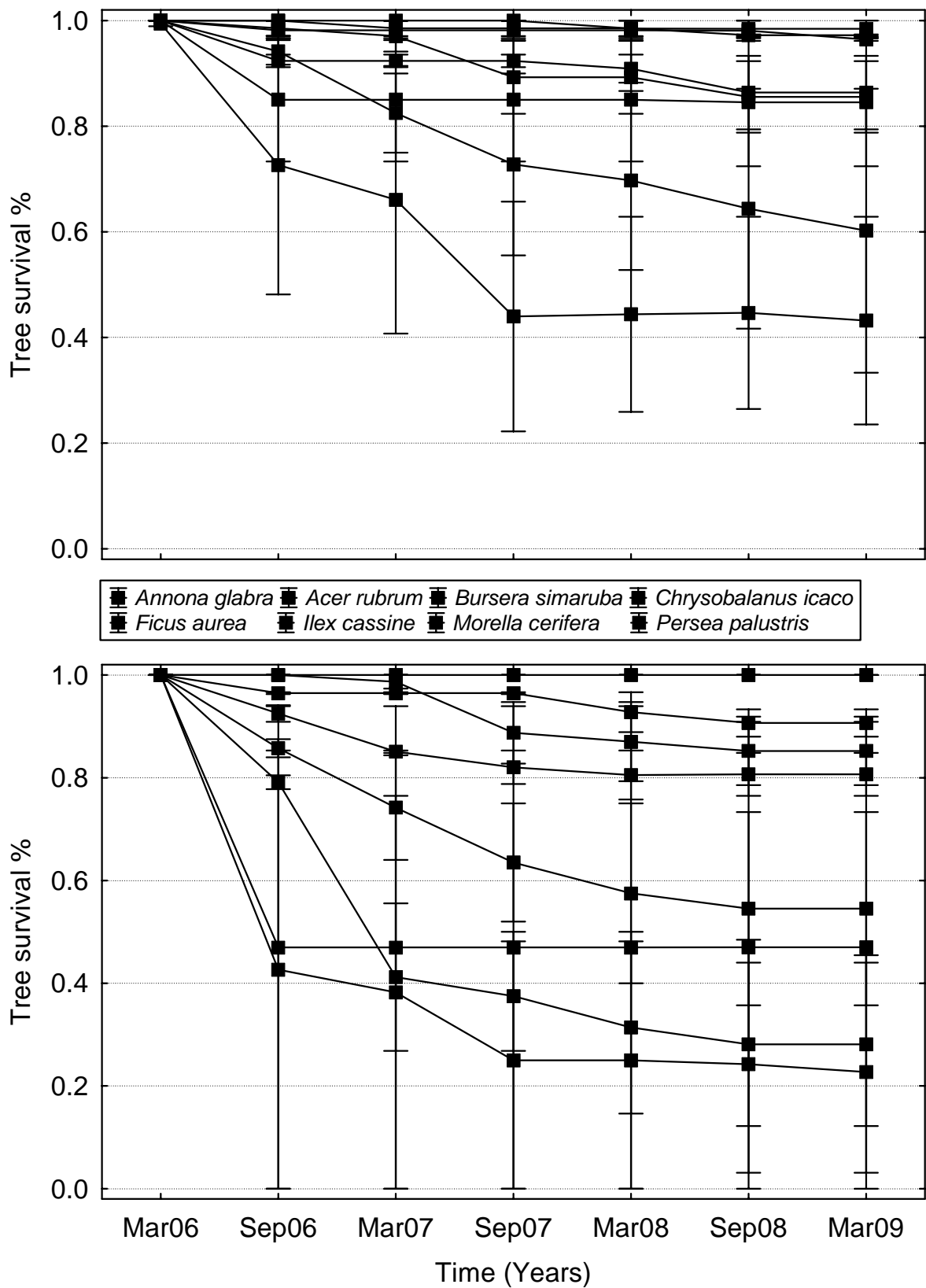

Figure 1: Mean (\pm SE) survival of all tree species in limestone (a) and peat (b) M1 and M4 tree islands.

Mean species height on each island at 6-month intervals are shown in Figure 2. The figure demonstrates that tree growth was concentrated in the March-September period in all three years for all species and for all tree islands. The effect of substrate type is also shown in this figure with trees growing better in peat than in limestone tree islands.

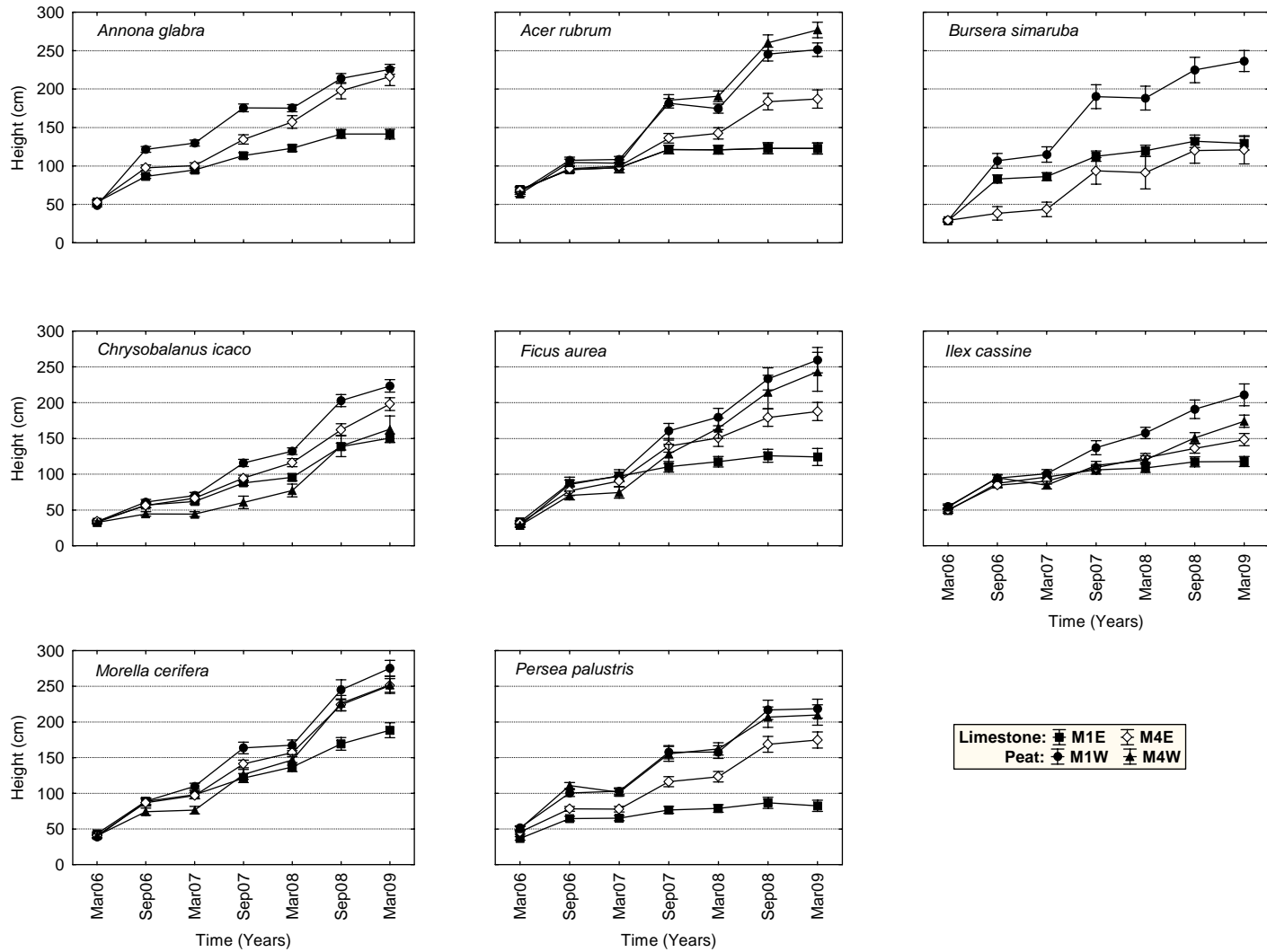

Figure 2: Mean plant height (\pm SE) of eight species in two peat and two limestone tree islands, March 2006-March 2008.

Survival and growth were compared between substrate types using ANOVA. The limestone core was placed below a flat center portion (14 x 49 m) of the total tree island surface (43 x 71 m) so individuals planted within the limestone core area were compared with individuals planted on similar area in peat tree islands. All species except *A. rubrum* and *I. cassine* showed higher survival in limestone than in peat tree islands (Table 3).

Species	Limestone	Peat	p
<i>Annona glabra</i>	85	48	<0.01
<i>Acer rubrum</i>	96	100	0.99
<i>Bursera simaruba</i>	44	24	<0.05
<i>Chrysobalanus icaco</i>	86	55	<0.01
<i>Ficus aurea</i>	58	24	<0.01
<i>Ilex cassine</i>	85	91	0.32
<i>Morella cerifera</i>	98	81	<0.01
<i>Persea palustris</i>	97	86	<0.05

The effect of substrate type on tree height growth during the first 3 years after planting is illustrated in Table 4. All species were significantly taller in peat than in limestone tree islands.

	Limestone	Peat	p
<i>Annona glabra</i>	173	223	<0.01
<i>Acer rubrum</i>	153	264	<0.01
<i>Bursera simaruba</i>	127	237	<0.01
<i>Chrysobalanus icaco</i>	175	204	<0.01
<i>Ficus aurea</i>	168	254	<0.01
<i>Ilex cassine</i>	134	190	<0.01
<i>Morella cerifera</i>	221	264	<0.01
<i>Persea palustris</i>	131	215	<0.01

In general survival and growth results in M1 and M4 three years after planting continued the trend established through 30 months, which are presented in the first Section of the present report. Little additional mortality occurred during the period September 2008 - March 2009, and cumulative survival remained at 61%. Tree height increased very little during the September 2008– March 2009 period, which is consistent with the pattern of reduced dry season growth exhibited prior to September 2008. Survival response to RE remained the same with higher survival and growth with increasing RE. Higher survival in limestone and taller trees in peat tree islands also matched results obtained six months before.

Effects of hydrology and substrate types on tree survival and growth over 24 months (March 2007 to March 2009) in cells M2 and M3.

Our initial intent was to use identical experimental and analytical procedures on all eight islands. However, a few changes were made from the original selection of tree species due to limitations in nursery availability. *B. simaruba* was not available and was replaced by *Eugenia axillaris*. *P. palustris* seedlings received from the grower were sufficient for only two islands (M3E & W), so *Myrsine floridana* was substituted in the other two (M2E & W). *Myrcianthes fragrans* was planted in spots in M2W and M3E to solve a similar shortage of *F. aurea*, but was not included in the present analysis.

Survival and height of each planted seedling were recorded at 2-month intervals from March 2007 through March 2008 and at a six-month interval thereafter, i.e., in September 2008 and March 2009. During June 2007, we replanted seedlings at ~40 locations where the planted seedling had died soon after planting. Growth and survival among this “replanted” cohort is not included in the summary of plant response below.

Most of the species showed an increase in survival (Table 5) and/or growth (Table 6) as RE increased in both limestone and peat tree islands. Equation coefficients for the logistic regression model were used as metrics by which to rank the effects of RE on survival (Table 5), and thus to indicate the relative flood tolerances of the nine study species. *F. aurea*, *P. palustris*, *E. axillaris* and *M. floridana* were less tolerant to flooding conditions as indicated by their higher performance at higher RE. *I. cassine* and *C. icaco* were more tolerant to flooding than the previous species and *A. glabra*, *A. rubrum* and *M. cerifera* did not show any response to RE.

Species	Limestone	p-value	Peat	p-value
<i>Annona glabra</i>	0.005	NS	-0.02	<0.05
<i>Acer rubrum</i>	-0.02	NS	0.00	NS
<i>Chrysobalanus icaco</i>	0.02	<0.05	0.02	<0.05
<i>Eugenia axillaris</i>	0.10	<0.01	0.09	<0.01
<i>Ficus aurea</i>	0.20	<0.01	0.10	<0.01
<i>Ilex cassine</i>	0.07	<0.01	0.05	<0.01
<i>Morella cerifera</i>	0.01	NS	0.04	<0.01
<i>Myrsine floridana</i>	0.10	<0.01	0.05	<0.01
<i>Persea palustris</i>	0.15	<0.01	0.16	<0.01

Table 6: Linear regression coefficients and p-values of Relative Elevation on Growth through September 2009.				
Species	Limestone	p-value	Peat	p-value
<i>Annona glabra</i>	0.78	<0.01	0.92	<0.01
<i>Acer rubrum</i>	1.29	<0.01	1.24	<0.01
<i>Chrysobalanus icaco</i>	0.90	<0.01	1.50	<0.01
<i>Eugenia axillaris</i>	0.57	<0.01	0.36	<0.05
<i>Ficus aurea</i>	0.38	NS	1.57	NS
<i>Ilex cassine</i>	1.15	<0.01	1.37	<0.01
<i>Morella cerifera</i>	1.17	<0.01	1.23	<0.01
<i>Myrsine floridana</i>	2.13	<0.01	0.75	<0.05
<i>Persea palustris</i>	0.96	NS	1.27	<0.05

The time sequence of survival for all species is presented for limestone (Figure 3a) and peat (Figure 3b) tree islands. In M2 and M3, substrate in the eastern tree islands is wholly peat and the western islands are limestone based. *A. glabra* suffered high mortality in both peat and limestone tree islands, probably due to the poor quality of nursery plants. *F. aurea* and *M. floridana* also showed high mortality in both types of substrate. The lower survival could be attributed to accidental damage due to herbicidal and mechanical weed control used to reduce competition at the early stages of tree development.

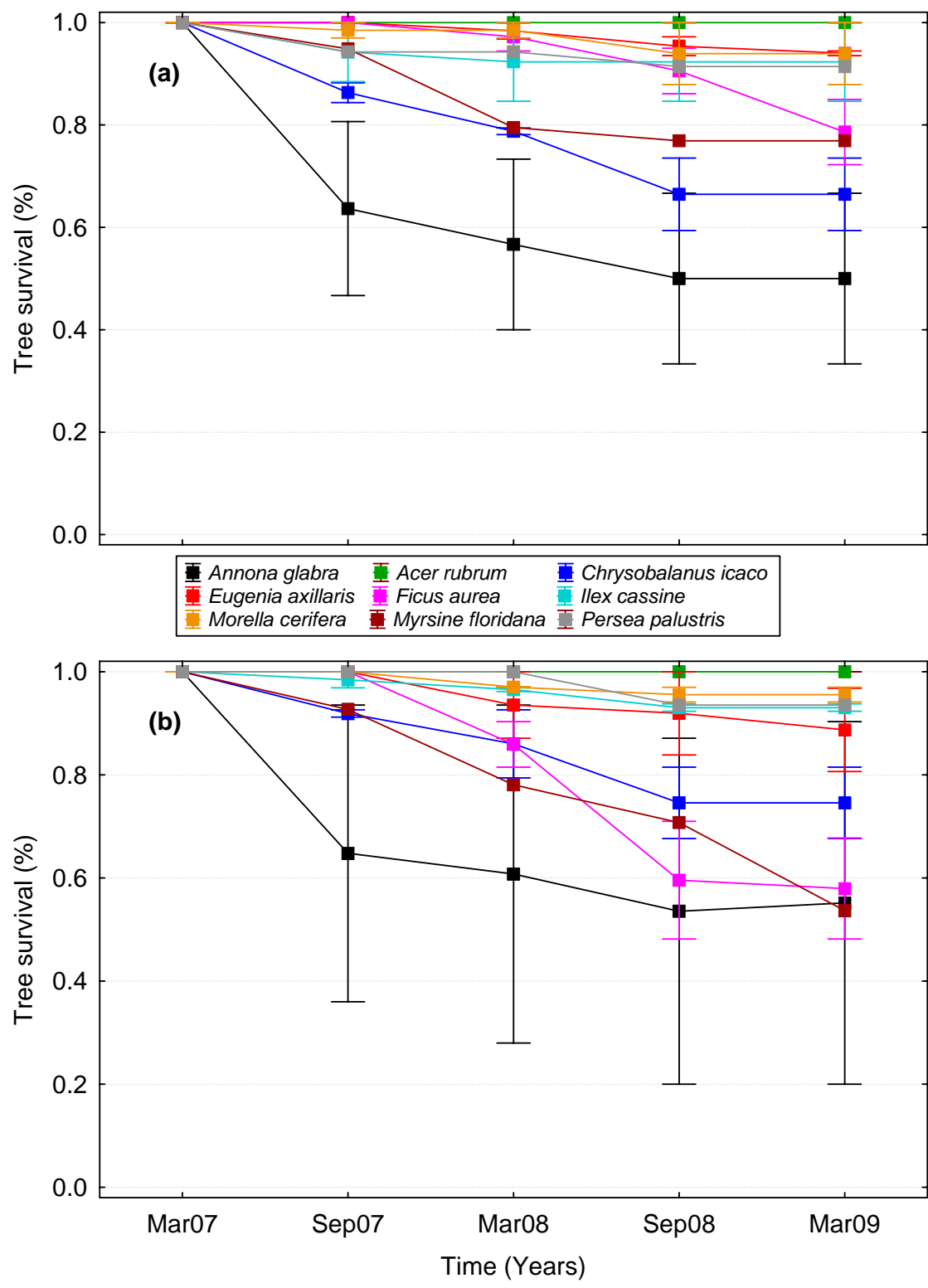

Figure 3: Mean (\pm SE) survival of all tree species in limestone (a) and peat (b) M2 and M3 tree islands.

Cumulative mean species height on limestone and peat tree islands at 6-month intervals is shown in Figure 4. In general two periods of growth acceleration can be distinguished, the first corresponding to the initial six-month period after planting (March to September 2007) and the second between March and September 2008. Tree height increased very little during the September 2007– March 2008 and September 2008– March 2009 periods. It is of interest that the same seasonal pattern i.e., rapid in the wet season, slower during the dry season, was observed for three year-old individuals in cells M1 and M4. A relationship between species and substrate is suggested in Figure 4, with *A. glabra*, *F. aurea* and *I. cassine* growing better on peat substrate.

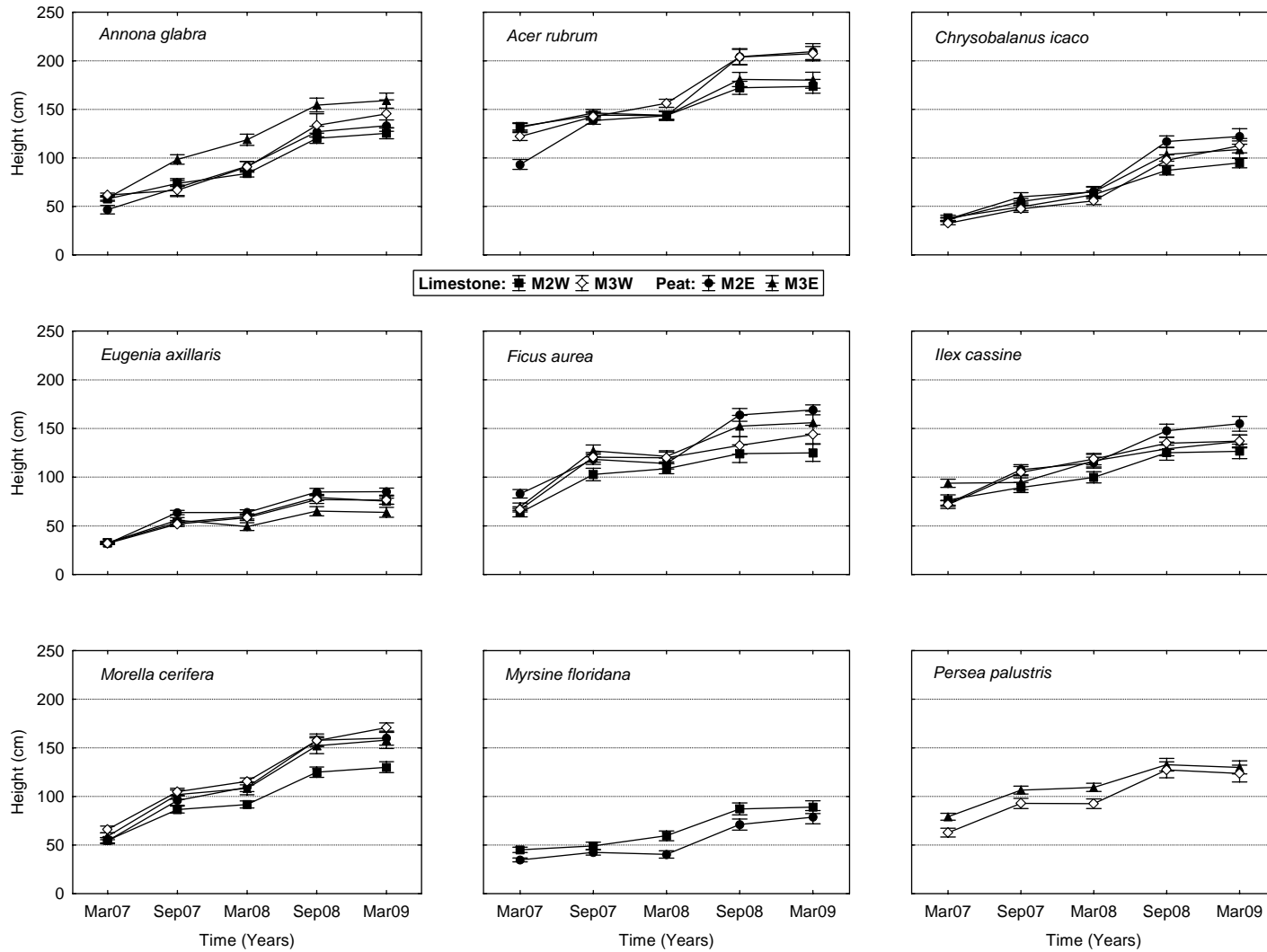

Figure 4: Mean plant height (\pm SE) of nine species in two peat and two limestone tree islands, March 2007-March 2009.

Survival and growth were compared between substrate types using ANOVA. The limestone core was placed below a flat center portion (14 x 49 m) of the total tree island surface (43 x 71 m) so individuals planted within the limestone core area were compared with individuals planted on similar area in peat tree islands. *F. aurea* and *M. floridana* were the only species with higher survival in limestone than in peat tree islands in March 2009 (Table 7).

Table 7: ANOVA (p-values) of survival percentages in M2 and M3 limestone and peat tree islands through March 2009.			
Species	Limestone	Peat	p
<i>Annona glabra</i>	49	57	0.42
<i>Acer rubrum</i>	100	100	0.99
<i>Chrysobalanus icaco</i>	66	74	0.40
<i>Eugenia axillaris</i>	94	89	0.29
<i>Ficus aurea</i>	77	59	<0.05
<i>Ilex cassine</i>	92	91	0.86
<i>Morella cerifera</i>	94	95	0.67
<i>Myrsine floridana</i>	77	54	<0.05
<i>Persea palustris</i>	89	93	0.51

In March 2009, two years after planting, only three species, *A. glabra*, *F. aurea* and *I. cassine* were taller in peat than in limestone tree islands (Table 8).

Table 8: ANOVA (p-values) of survival percentages in M2 and M3 limestone and peat tree islands through March 2009.			
Species	Limestone	Peat	p
<i>Annona glabra</i>	132	152	<0.05
<i>Acer rubrum</i>	188	193	0.60
<i>Chrysobalanus icaco</i>	102	115	0.08
<i>Eugenia axillaris</i>	76	75	0.92
<i>Ficus aurea</i>	136	165	<0.01
<i>Ilex cassine</i>	131	147	<0.05
<i>Morella cerifera</i>	152	158	0.36
<i>Myrsine floridana</i>	89	77	0.29
<i>Persea palustris</i>	123	130	0.57

As described in Section 1, in M1 and M4 both survival and growth increased with RE, but the response for these two life history parameters differed in magnitude on the two island types; the survival response was most notable on limestone tree islands, while growth responded most positively on peat-based islands. The 24-month survival and growth in M2 and M3 also increased with RE, but the response was equally strong and consistent in both island types. Little mortality occurred between September 2008 and March 2009, except among *F. aurea* seedlings on limestone and *M. floridana* individuals on peat tree islands. As such, only these species showed a decline in survival during the last six month period. The seasonal patterns of height growth displayed on both limestone and peat tree islands were similar for both planting cohorts.

Except for *F. aurea* and *M. floridana*, which survived better on limestone tree islands, variation in survival was not a function of island type. Only three species, *A. glabra*, *F. aurea* and *I. cassine*, were taller on peat islands than limestone islands, a pattern exhibited by all eight species in the 2006 planting cohort.

Section 3

Tree Islands' vegetation survey and habitat analysis

The LILA project consists of four pairs of tree islands (eight total). Each 35m x 50m island is roughly divided into a high ground area, the plateau, and a slope which descends into the surrounding marsh. Slope and plateau were marked off with PVC poles in each plot (see Figure 5). Within each island and zone, we identified all plant species and estimated their cover. The preliminary data were collected in July 2006, and re-sampling occurred in January and February 2008. The islands in M1 and M4 were planted in 2006 and the islands in M2 and M3 were planted in 2007. As such, when the preliminary cover data were collected in 2006, there were planted trees on the islands in M1 and M4, but not on the islands in M2 and M3.

Over the course of the one and a half years, 114 species were identified on the islands, not including the planted tree species. Of these, 106 were herbaceous plants and eight were woody. The woody plants were *Baccharis halimifolia*, *Cephalanthus occidentalis*, *Salix caroliniana*, *Senna ligustrina*, and seedlings of *Annona glabra*, *Quercus laurifolia*, *Schinus terebinthifolius*, and *Taxodium distichum*.

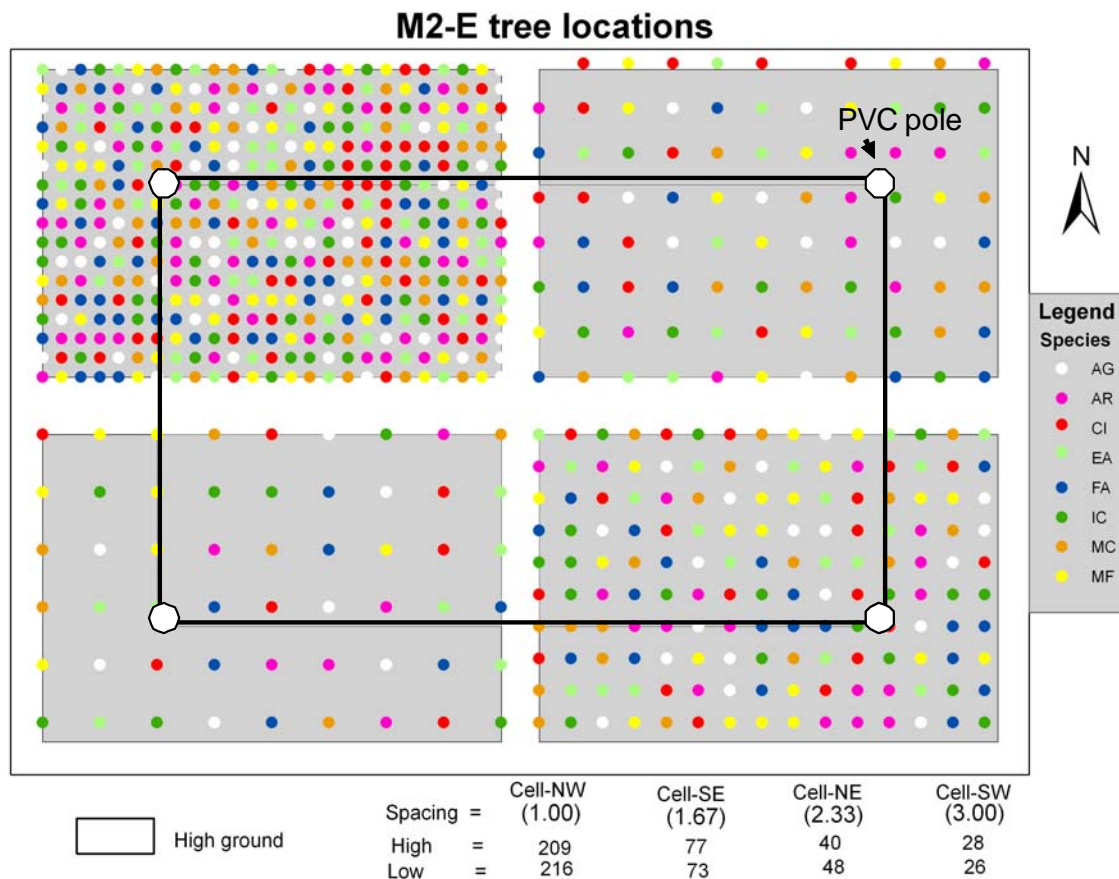

Figure 5: Plateau and slope areas (inside and outside rectangle) marked with PVC poles in M2-E tree island.

Slope – The mean species richness for the slope area (875m²) in 2006 was 35.63. The dominant species occurring at this point in time were *Rhynchospora nitens*, *Pluchea odorata*, *Echinochloa walteri*, *Panicum hemitomon*, and *Eupatorium capillifolium*. Other species that had cover values over 16% on an island were *Eleocharis cellulosa*, *Leersia hexandra*, *Paspalidium geminatum*, *Cyperus odoratus*, *Mikania scandens*, and *Kosteletzkya virginica* (Table 11).

Mean species richness for the slope area (875²) in 2008 was 33.88. The dominant species occurring here were *Pontederia cordata*, *Panicum hemitomon*, *Leersia hexandra*, and *Echinochloa walteri*. Other species with cover values over 16% on an island were *Kosteletzkya virginica*, *Rhynchospora inundata*, *Sagittaria lancifolia*, *Ludwigia repens*, and *Panicum repens* (Table 11).

The dominant species present in the slope area in 2006 represent a flora tolerant of moist to seasonally wet conditions, and dying out under extended inundation. The 2008 census shows a shift to species that are tolerant of extended inundation, or the extension of rooted plants further down the sides of the islands. However, the 2006 data was collected in July near the beginning of the wet season, and the species present may be persistent from the dry season. Conversely, the 2008 data was collected in January and February at the end of the wet season, and may denote a flora persistent after 6 months of inundation. A further sample should be taken in July to compare for seasonal fluctuations.

M1 Slope – There were 63 species recorded on the slope of the islands in M1. Of these, 32 species that were present in 2006 remained present in 2008. There were 19 species occurring on the islands in M1 in 2006 that were not present in 2008. By contrast, there were 12 species that were not present in 2006 that are now present in 2008 (Table 13). Seedlings of *Annona glabra* are now a recent volunteer, and may be progeny of the planted trees. Four grass species present in 2006 (*Setaria parviflora*, *S. magna*, *Panicum rigidulum*, *Dichanthelium dichotomum*) were absent from the flora in 2008. The loss of these species may be due to the area becoming wetter, or seasonality in species growth. Some of the new species found in 2008 not present in 2006 were *Nymphaea odorata*, *Eleocharis elongata*, and the algae *Chara* sp. These are species tolerant of extended inundation and indicative of long hydroperiod.

M2 Slope - There were 57 species recorded on the slope of the islands in M2. Of these, 26 species that were present in 2006 remained present in 2008. There were 8 species occurring on the islands in M2 in 2006 that were not present in 2008. By contrast, there were 23 species that were not present in 2006 but present in 2008. New species present in 2008 include the exotic grass *Panicum repens* and a few species such as *Nymphaea odorata*, *Utricularia foliosa*, two species of *Typha*, and the algae *Chara* sp. that are indicator of wetter habitat (Table 13).

M3 Slope - There were 50 species recorded on the slope of the islands in M3. Of these, 27 species that were present in 2006 remained present in 2008. There were 11 species occurring on the islands in M1 in 2006 that were not present in 2008. By contrast, there were 12 species that were not present in 2006 but present in 2008. Defining a wetter habitat, new species present in 2008 include *Utricularia foliosa*, *U.gibba*, *Nuphar lutea*, *Typha domingensis*, and the algae *Chara* sp. (Table 13).

M4 Slope - There were 59 species recorded on the slope of the islands in M4. Of these, 24 species that were present in 2006 remained present in 2008. There were 20 species occurring on the islands in M1 in 2006 that were not present in 2008. By contrast, there were 15 species that were not present in 2006 but present in 2008 (Table 13). The nature of species in these two groups gives little indication of changing hydrologic conditions.

Table 11: Slope dominant plant species recorded on the LILA tree islands in 2006 and 2008. For dominant species codes see Table 13

Plot	Year	# Species	Dominant species codes
M1W-Slope	2006	45	RHYNIT, ECHWAL, PLUODO
M1W-Slope	2008	37	SAGLAN, PONCOR RHYNIT, PANHEM, ECHWAL, ELECEL, LEEHEX PASGEM, PLUODO
M1E-Slope	2006	45	
M1E-Slope	2008	38	PANHEM, PONCOR, SAGLAN
M2W-Slope	2006	33	RHYNIT, PLUODO, PANHEM, LEEHEX
M2W-Slope	2008	38	PONCOR, LEEHEX
M2E-Slope	2006	26	RHYNIT, PLUODO, PANHEM, EUPCAP, CYPODO
M2E-Slope	2008	38	ECHWAL, PANHEM, PONCOR, RHYINU
M3W-Slope	2006	24	RHYNIT, PANHEM, MIKSCA, EUPCAP
M3W-Slope	2008	34	LEEHEX, PANHEM, ECHWAL, PONCOR
M3E-Slope	2006	39	PANHEM, ELEGEN, EUPCAP, KOSVIR, RHYNIT
M3E-Slope	2008	34	PONCOR, KOSVIR, LUDREP
M4W-Slope	2006	35	RHYNIT, ECHWAL
M4W-Slope	2008	22	PONCOR, LEEHEX
M4E-Slope	2006	38	RHYNIT, ECHWAL, PLUODO, KOSVIR
M4E-Slope	2008	30	PANHEM, PANREP, PANRIG
2006 Avg. # species on slope	35.63		
2008 Avg. # species on slope	33.88		

Plateau – The mean species richness for the plateau area (875m²) in 2006 was 22.13, a full 13 species less than encountered on the slope. The disparity in diversity is due to the wide range of wet to dry habitat in the slope area. The plateau encompasses only the highest ground of each island, while the slope consists of the low lying, wet areas plus part of the higher and drier upper areas of the slope. Therefore, the slope will have species that occur in the wet areas as well as species occurring on drier ground, thus, adding to species diversity. The dominant species occurring on the plateau in 2006 were *Pluchea odorata*, *Rhynchospora nitens*, *Kosteletzkya virginica*, and *Echinochloa walteri*. Other species occurring with cover values over 16% on an island were *Mikania scandens* and *Eupatorium capillifolium* (Table 12).

Mean species richness on the plateau area (875m²) in 2008 was 25.38, which was eight species lower than that encountered on the slope. The edges of the plateau experienced inundation during the wet season and, thus, species more tolerant of wet conditions (*Pontederia cordata*, *Sagittaria lancifolia*, *Ludwigia repens*, and *Panicum hemitomen*) expanded their range from the slope into the plateau. This could explain the more evenly distributed diversity in the slope and plateau in 2008. The dominant species encountered on the plateau in 2008 were *Pluchea odorata*, *Echinochloa walteri*, *Kosteletzkya virginica*, and *Ambrosia artemisiifolia* (Table 12).

M1 Plateau – There were 61 species recorded on the plateau of the islands in M1. Of these, 17 species that were present in 2006 remained present in 2008. There were 20 species occurring on the islands in M1 in 2006 that were not present in 2008. By contrast, there were 24 species that were not present in 2006 but present in 2008 (Table 13). Seedlings of *Annona glabra* also appeared on the plateau, much as they did on the slope. Seedlings of the exotic shrub *Schinus terebinthifolius* appeared in 2008. These seedlings were found around the bases of the planted trees and may have been brought in with the potted trees in 2006. Five grass species

present in 2006 (*Sacciolepis striata*, *Setaria magna*, *Panicum rigidulum*, *Cenchrus echinatus*, *Cynodon dactylon*) were not found in 2008. These grasses may be pioneer species that are now being outcompeted or are susceptible to repeated spraying. Some of the new species (*Pontederia cordata*, *Ludwigia repens*, *Polygonum hydropiperoides*, *Saururus cernus*) found in 2008 are adapted to a longer hydroperiod and may be indicative of a wetter trend in the lower plateau areas.

M2 Plateau – There were 49 species recorded on the plateau of the islands in M2. Of these, 12 species were present in both years. Ten species were only observed on the M2 islands in 2006. By contrast, 27 species that were absent in 2006 appeared in 2008 (Table 13).

M3 Plateau – There were 46 species recorded on the plateau of the islands in M3. Of these, seven species that were present in 2006 remained present in 2008. Seventeen species were present only in 2006, and that were only observed in M3 in 2006, and 22 species were observed for the first time in 2008 (Table 13). Both M2 and M3 showed the same progression from 2006 to 2008: occupation by grass species characteristic of dry sites to a predominance of species tolerant of a wetter, longer hydroperiod. This trend was evident on all four pairs of islands and may be attributable to the season in which the census was conducted (see above).

M4 Plateau – There were 53 species recorded on the plateau of the islands in M4. Of these, 14 species present in 2006 remained in 2008. Eleven species present in 2006 were absent in 2008. By contrast, 28 species that were absent in 2006 were observed in 2008 (Table 13). Many of these species (*Ludwigia repens*, *Peltandra virginica*, *Pontederia cordata*, *Prosepinaca palustris*, *Saururus cernus*) are characteristic of long hydroperiod marshes. Two exotic species (*Schinus terebinthifolius*, *Panicum repens*) were found in 2008.

Table 12: Plateau dominant plant species recorded on the LILA tree islands in 2006 and 2008. . For dominant species codes see Table 13

Plot	Year	# Species	Dominant species codes
M1W-Plateau	2006	29	RHYNIT, PLUODO
M1W-Plateau	2008	33	ECHWAL, PASGEM
M1E-Plateau	2006	29	PLUODO, RHYNIT, PANREP, KOSVIR, ECHWAL
M1E-Plateau	2008	26	PLUODO, PONCOR, PANHEM, KOSVIR, ECHWAL
M2W-Plateau	2006	22	PLUODO, KOSVIR
M2W-Plateau	2008	30	PLUODO, ECHWAL, AMBART
M2E-Plateau	2006	13	MIKSCA, PLUODO, EUPCAP, ECHWAL
M2E-Plateau	2008	21	ECHWAL, PLUODO
M3W-Plateau	2006	23	ECHWAL, PLUODO, MIKSCA
M3W-Plateau	2008	14	ECHWAL, PLUODO
M3E-Plateau	2006	20	PLUODO, EUPCAP, MIKSCA
M3E-Plateau	2008	23	PLUODO, KOSVIR, LUDREP
M4W-Plateau	2006	20	KOSVIR, RHYNIT
M4W-Plateau	2008	20	PLUODO, KOSVIR, ECHWAL
M4E-Plateau	2006	21	RHYNIT, PLUODO
M4E-Plateau	2008	36	PLUODO, KOSVIR, SAGLAN, AMBART
2006 Avg. # species on plateau	22.13		
2008 Avg. # species on plateau	25.38		

Table 13: Present/Absence table. X indicates presence at time of census and blank absence.																
Species Scientific Name, Codes	M1 (2006)		M1 (2008)		M2 (2006)		M2 (2008)		M3 (2006)		M3 (2008)		M4 (2006)		M4 (2008)	
	Slope	Plateau	Slope	Plateau	Slope	Plateau	Slope	Plateau	Slope	Plateau	Slope	Plateau	Slope	Plateau	Slope	Plateau
<i>Acrostichum danaeifolium</i>							X									
<i>Alternanthera philoxeroides</i>	X	X					X			X						
<i>Amaranthus australis</i>					X	X							X	X		
<i>Ambrosia artemisiifolia</i> , AMBART	X	X	X	X		X	X	X	X	X	X	X	X	X	X	X
<i>Ammannia latifolia</i>			X	X				X							X	X
<i>Andropogon glomeratus</i>			X					X			X				X	X
<i>Andropogon virginicus</i>	X				X				X	X				X		
<i>Annona glabra</i>			X	X												
<i>Aster subulatus</i>		X					X									
<i>Baccharis halimifolia</i>	X			X												
<i>Bacopa monnieri</i>			X	X			X	X			X		X		X	X
<i>Bidens alba</i>	X	X	X	X	X	X	X	X					X	X		
<i>Boehmeria cylindrica</i>	X		X	X	X	X	X	X	X			X	X	X	X	X
<i>Cardamine pensylvanica</i>				X			X	X			X	X				X
<i>Centalla asiatica</i>				X												
<i>Cenchrus echinatus</i>		X														
<i>Cephalanthus occidentalis</i>	X		X		X	X	X		X	X			X	X	X	X
<i>Chamaesyce blodgettii</i>	X	X			X								X	X		
<i>Chamaesyce hirta</i>	X	X														
<i>Chamaesyce hypericifolia</i>	X	X	X	X				X								X
<i>Chara sp.</i>			X				X				X				X	
<i>Commelina diffusa</i> var. <i>diffusa</i>	X															
<i>Conyza canadensis</i> var. <i>pusilla</i>									X	X			X			
<i>Conoclinium coelestinum</i>	X															
<i>Crinum americanum</i>	X		X	X	X		X	X								
<i>Cynodon dactylon</i>		X														
<i>Cyperus haspan</i>													X		X	
<i>Cyperus odoratus</i> , CYPODO	X	X			X	X	X	X	X	X	X	X	X	X	X	X
<i>Dactyloctenium aegyptium</i>		X				X	X	X					X	X		
<i>Dichanthelium dichotomum</i>	X								X		X					X
<i>Diodia virginiana</i>	X								X	X		X	X			
<i>Echinochloa walteri</i> , ECHWAL	X	X	X	X	X	X	X	X	X	X	X	X	X	X	X	X
<i>Eclipta prostrata</i>								X				X			X	
<i>Eleocharis cellulosa</i> , ELECEL	X		X		X		X		X		X		X		X	
<i>Eleocharis elongata</i>			X		X				X		X					

<i>Eleocharis geniculata</i> , ELEGEN	X		X	X			X	X	X		X	X	X		X	X
<i>Eleusine indica</i>								X								
<i>Eleocharis interstincta</i>	X		X		X				X		X				X	X
<i>Eleocharis vivipara</i>			X				X	X			X	X			X	
<i>Emilia sonchifolia</i>								X								
<i>Erechtites hieracifolia</i>			X	X								X				
	M1 (26)		M1 (28)		M2 (26)		M2 (28)		M3 (26)		M3 (28)		M4 (26)		M4 (28)	
	Slope	Plateau	Slope	Plateau	Slope	Plateau	Slope	Plateau	Slope	Plateau	Slope	Plateau	Slope	Plateau	Slope	Plateau
<i>Eupatorium capillifolium</i> , EUPCAP	X	X	X	X	X	X	X		X	X	X		X	X		
<i>Eustachys petraea</i>			X	X								X				X
<i>Fuirena breviseta</i>								X				X				
<i>Vicia acutifolia</i>				X												
<i>Heliotropium polyphyllum</i>		X														
<i>Hibiscus grandiflorus</i>			X													
<i>Hydrocotyle umbellata</i>								X	X							
<i>Hymenocallis palmeri</i>				X												
<i>Ipomoea sagittata</i>	X	X	X	X	X	X			X	X	X		X		X	X
<i>Justicia angusta</i>	X	X	X		X		X	X								
<i>Kosteletzkya virginica</i> , KOSVIR	X	X	X	X	X	X	X	X	X	X	X	X	X	X	X	X
<i>Lachnanthes caroliana</i>					X	X										
<i>Leersia hexandra</i> , LEEHEX	X	X	X	X	X	X	X	X	X	X	X		X		X	X
<i>Ludwigia alata</i>	X						X									X
<i>Ludwigia leptocarpa</i>							X									
<i>Ludwigia octovalvis</i>			X	X			X	X			X	X			X	X
<i>Ludwigia peruviana</i>							X	X							X	X
<i>Ludwigia repens</i> , LUDREP	X		X	X			X	X	X		X	X	X			X
<i>Luziola fluitans</i>													X			
<i>Lythrum alatum</i> var. <i>lanceolatum</i>	X														X	X
<i>Mikania scandens</i> , MIKSCA	X	X	X	X	X	X	X	X	X	X	X	X	X	X	X	X
<i>Mitreola petiolata</i>	X	X	X	X	X	X	X	X	X	X	X		X	X		X
<i>Nuphar lutea</i>											X				X	
<i>Nymphaea odorata</i>			X				X		X		X	X				
<i>Panicum hemitomon</i> , PANHEM	X	X	X	X	X	X	X		X	X	X		X	X	X	X
<i>Panicum repens</i> , PANREP	X	X	X				X						X		X	X
<i>Panicum rigidulum</i> , PANRIG	X	X					X	X		X	X		X		X	X
<i>Paspalidium geminatum</i> , PASGEM	X	X	X	X	X		X		X		X				X	
<i>Passiflora suberosa</i>								X								
<i>Peltandra virginica</i>	X	X	X	X	X		X	X	X	X	X	X	X		X	X

<i>Physalis angustifolia</i>				X											X	X
<i>Phyllanthus urinaria</i>										X						
<i>Pilea microphylla</i>	X															
<i>Pistia stratiotes</i>												X				
<i>Pluchea odorata</i> , PLUODO	X	X	X	X	X	X	X	X	X	X	X	X	X	X	X	X
<i>Pluchea rosea</i>	X	X	X	X		X										
<i>Polygonum hydropiperoides</i>	X	X	X	X	X		X	X	X		X	X	X	X	X	X
<i>Pontederia cordata</i> , PONCOR	X	X	X	X	X		X	X	X		X	X	X		X	X
<i>Portulaca oleracea</i>	X	X				X							X			
<i>Proserpinaca palustris</i>							X		X		X		X			X
<i>Quercus laurifolia</i>																X
<i>Rhynchospora colorata</i>		X			X				X				X	X		
	M1 (26)		M1 (28)		M2 (26)		M2 (28)		M3 (26)		M3 (28)		M4 (26)		M4 (28)	
	Slope	Plateau	Slope	Plateau	Slope	Plateau	Slope	Plateau	Slope	Plateau	Slope	Plateau	Slope	Plateau	Slope	Plateau
<i>Rhynchospora inundata</i> , RHYINU	X	X			X		X		X		X	X	X		X	
<i>Rhynchospora microcarpa</i>			X													
<i>Rhynchospora nitens</i> , RHYNIT	X	X			X	X	X	X	X	X		X	X	X		
<i>Rhynchospora tracyi</i>									X							
<i>Sacciolepis striata</i>	X	X	X		X		X		X	X	X		X	X	X	X
<i>Sagittaria lancifolia</i> var. <i>lancifolia</i> , SAGLAN	X	X	X	X	X		X	X	X	X	X	X	X	X	X	X
<i>Salix caroliniana</i>	X	X	X		X		X	X	X		X	X	X		X	X
<i>Sarcostemma clausum</i>				X												
<i>Saururus cernuus</i>	X		X	X			X		X		X	X				X
<i>Schinus terebinthefolius</i>				X												X
<i>Scoparia dulcis</i>								X				X			X	X
<i>Senna ligustrina</i>																
<i>Sesbania herbacea</i>									X				X	X		X
<i>Setaria magna</i>	X	X			X	X			X	X			X	X	X	
<i>Setaria parviflora</i>	X	X			X		X							X		
<i>Sida acuta</i>																
<i>Solanum americanum</i>	X	X		X		X			X	X			X	X		
<i>Spermacoce assurgens</i>				X				X								
<i>Taxodium distichum</i>	X	X	X													
<i>Typha domingensis</i>							X	X			X	X			X	
<i>Typha latifolia</i>							X									
<i>Utricularia foliosa</i>							X				X					
<i>Utricularia gibba</i>							X				X	X				

Task 5 Deliverables included conducting vegetation surveys, including tree survivorship until and after planting (Tasks 5a-e). Tasks 5a and 5c also require the planting of trees on the eight tree islands. As the above sections show, all required work for this task has been accomplished.

8. Task 6. Soil/Sediment Transport, Accretion, Loss, and Tree Island Morphology

The objective of this task was to determine the affects water flow would have on the movement of soil materials around tree islands (TI). It is believed that the characteristic teardrop shape of Everglades TI developed because materials (soils) are moved from areas of production around the TI heads towards the tails by flowing water. We originally proposed three methods to attempt to identify the affect of water flow on TI morphology including: 1 - collecting entrained particulate material in conjunction with water velocity transect work (section 6 Task 4 Hydrology), 2 – establishing benchmarks at specific locations around TI, and 3- establishing feldspar markers on tree islands. As previously mentioned, we are not conducting velocity transect experiments as they do not provide information needed to determine the complex flow patterns in LILA. We therefore have also not conducted the particulate trapping experiments. However, in concert with the dye studies that more adequately defined flow patterns in the mesocosms (section 6.2.5) we analyzed the fluorescent signature of the dye plumes as they made their way through the cells.

We used the dye fluorescence as a proxy to the movement of a water molecule or a neutrally buoyant particle (Hubbard et al. 1982). Theoretically, bell-shaped curves should result with the initial increase in slope corresponding to the elapsed time (T_e) of the leading edge of the “plume”. The maximum height corresponds to the elapsed time of the peak of the plume concentration (T_p). The fluorescence, proportional to dye or particle concentration, resulting from our studies (analyzed fluorescence units; AFU) are shown in Figure 8.1. As can be seen from these curves “typical bell-shaped curves” rarely result. This is due to several factors not least of which is hysteresis caused by vegetation. The plotted lines track dye concentrations at specific points (similar arrangement in M2 and M4) where SS = shallow slough, RS = restricted slough, WDS = west deep slough, WDN = west deep slough north side of island, EDS = east island deep slough, and EDN = east island deep slough north side (Fig. 8.2). The resulting curves were used to estimate T_e and T_p at the various locations as shown for the WDS and SS sites of M2 and M4 (Fig. 8.3). The values, in minutes, for T_e are estimated and shown by the first vertical line and the T_p are estimated from the second corresponding vertical line. Estimated values are given in Table 8.1 and generally show slower flow, and therefore particle movement into shallow slough when compared to the deep sloughs. This is consistent with visual estimates as made in section 6.2.5.

In April and May 2007 we established feldspar markers on the corners and along the center line of each of the eight LILA tree islands (Fig. 8.4). Feldspar markers were placed “inline” with the permanently installed corner marker posts approximately half-way up the tree island slope. A marker at the head and tail of the tree islands was placed off-slope on the slough surface. We installed the feldspar with the intention that these markers would appear on the aerial

photographs taken in June 2007. We attempted to revisit the feldspar markers within a few months of putting them down. The feldspar had not remained in place, rather there was evidence that the feldspar washed off the slopes of the TI (Figure 8.5). We were not able to locate any of our feldspar markers by the time of the first six month survey of November 2007.

Although our initial feldspar markers were not effective, we continue to develop methods to determine soil movement and tree island morphological change. During this contract period we designed and installed (through a contractor) Sedimentation and Erosion Tables (SETs) platforms on all eight tree islands. Two SETs are located downstream of the tree islands with one centered downstream on the surface of the deep slough and the other centered at mid-slope of the tree island “tail” (Fig. 8.6). Boardwalks have been constructed to assist in SET access. Two additional SETs are located, one at a high elevation and one on the wet slope of the highest density tree planting, on each island. The locations of the sets have been added to the GIS data base and can be georectified to aerial images (Fig. 8.7 and also Fig. 5.15). Figure 8.8 shows one of the tail tree island boardwalks.

As part of the amended contract RS-050962-A2 we made the first round of SET measurements on all tree islands in the spring 2009 (Table 8.2 as example). This involved measuring nine SET pins along a radial arm extending into four directions totaling 36 measures per SET. There are four SETs per tree island and 8 tree islands totaling 1152 data points. Additionally, and in concert with the establishment of the SET plots we re-installed feldspar markers. This latest set of feldspar used approximately 7.5 kg of feldspar per marker in a circle pattern (shaped by the bottom of a cut off pail) with an area of 0.145 m². This resulted in a marker thickness of about 5 cm, thicker than we originally anticipated and than our original markers of May 2007. We positioned 3 feldspar markers in the vicinity of each SET. We therefore established three markers per SET, four SETs per tree island, and eight tree islands for 96 total markers. We found that placing feldspar markers in flooded conditions was made easier if we made a thick slurry by first mixing the feldspar with a minimum of water and then freezing this mixture in pails in a -40° C freezer. These frozen feldspar disks were then transported to the field in large insulated freezer bags and placed where desired. These disks sank below the water and rested on the soil surface displacing flocculent materials which rapidly covered the markers. As the disks melt they deposit the feldspar in place (Fig. 8.9).

Early in the study we established markers at each of the four corners of each of the eight LILA TI, the locations of which have been georectified. The integration of the georectified aerial photographs on a GIS database, and eventually ground-truthed elevation measures should show large scale morphological changes in tree islands. Although still in nascent stages there may be the development of tails on the M2W Tree Island (Fig. 8.10). This series of images all show the same area and the development of accumulating vegetation downstream of the tree island.

Hubbard, E.F., Kilpatrick, F.A., Martens, L.A., and Wilson, J.F., Jr. 1982. Measurement of time of travel and dispersion in streams by dye tracing: U.S. Geological Survey Techniques of Water-Resources Investigations, Book 3, Chapter A9, 44 p.

Task 6 Deliverables included the installation of several markers and feldspar plots (6a) with measurements of soil change with time (6b-6f). Soil elevation change has not been conducted as our original plots were destroyed. However, we readapted our strategy to again establish feldspar plots and additionally installed, established, and measured soil elevations at 32 SETs at LILA (task 6g not included in original contract but added with amendment 2). Additionally, the entrained particles were not collected as part of the velocity experiments (Task 6b – d), rather fluorescent dyes were used as a proxy for particle movement in the velocity studies. Although the deliverables of this task have been altered (with consultation of SFWMD scientists and project managers), all basic deliverables have been met.

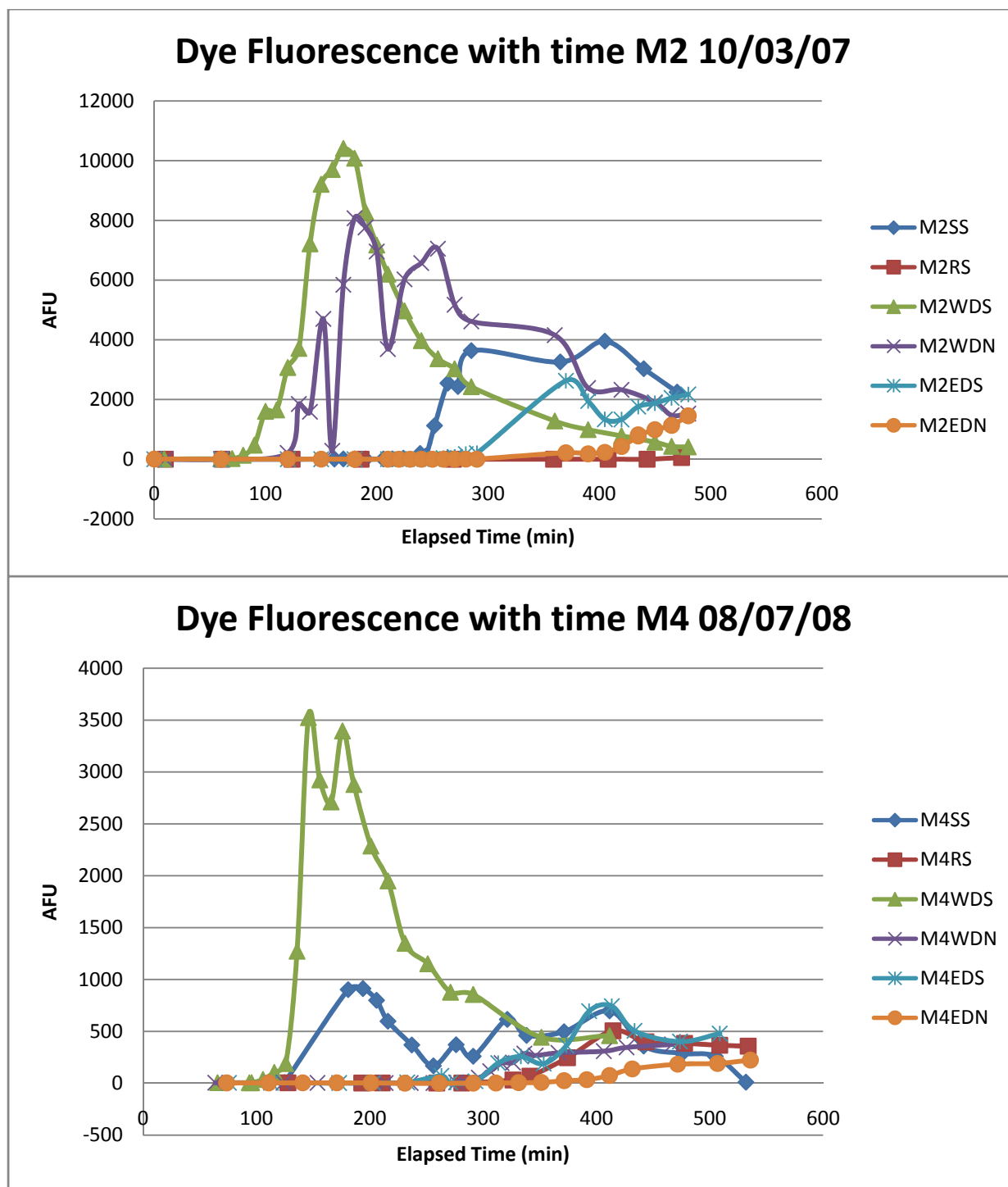

Figure 8.1. Analyzed fluorescence units (AFU) of Rhodamine dyes in dye tests of LILA mesocosms M2 and M4.

Figure 8.2. Locations in either M2 or M4 where water samples containing fluorescent dye were collected.

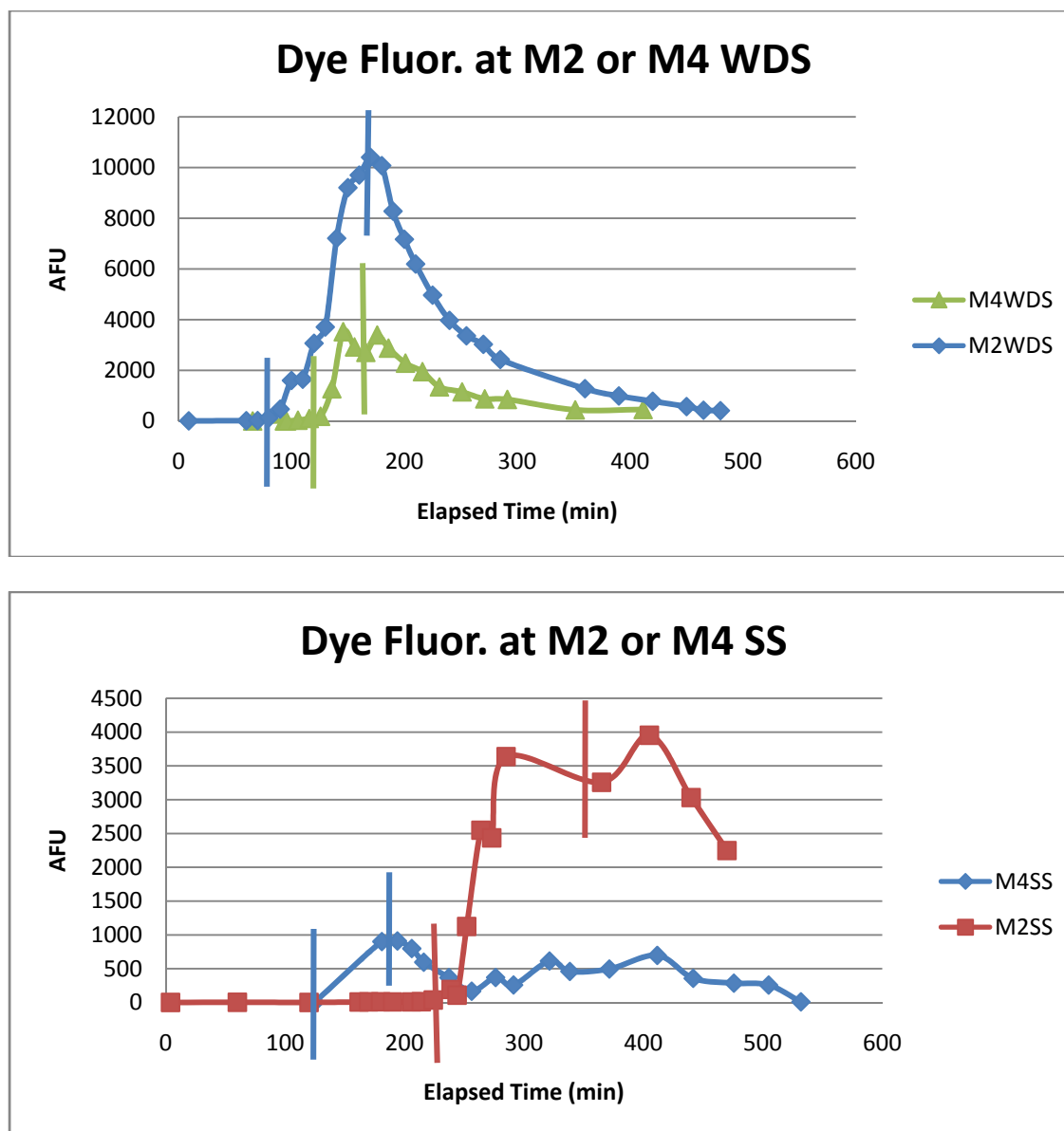

Figure 8.3. “Bell” shaped curves from M2 and M4 at the WDS and SS locations. First corresponding vertical line estimates the elapsed time of travel of a neutrally buoyant particle (T_e), the second vertical line is the elapsed time to the peak (T_p) of a dye or neutrally buoyant particle cloud. Estimates best fit to similar curves were used to derive values in Table 8.1.

Table 8.1. Elapsed time of leading edge and peak concentration of a dye cloud or a neutrally buoyant particle at various location in mesocosms M2 or M4 during dye studies. Greater than signs suggest that the curves were not “complete” and therefore the peak might be at a greater maximum. * suggests a difficult curve to interpret.

Mesocosm	Location	Elapsed time leading edge (T_e , min)	Elapsed time peak concentration (T_p , min)
M2	SS	244	365
	RS	NA	NA
	WDS	80	170
	WDN	120	210*
	EDS	290	370
	EDN	370	>480
M4	SS	125	194
	RS	281	415
	WDS	106	166
	WDN	276	>467
	EDS	293	414
	EDN	351	>536

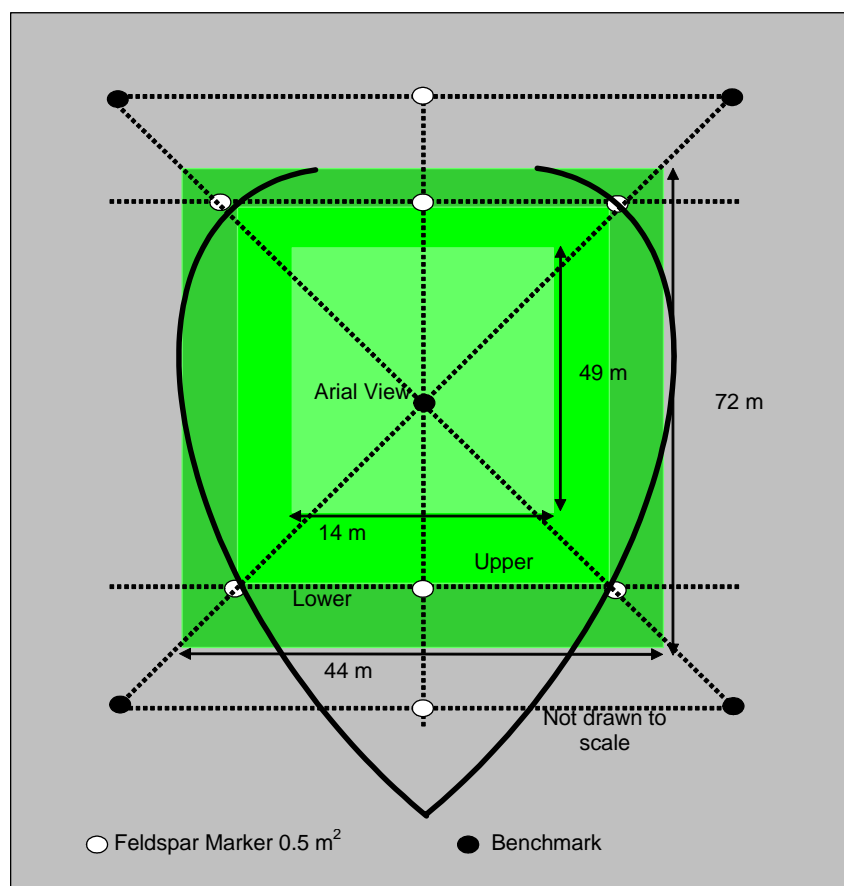

Figure 8.4. Locations of corner markers and Feldspar plot establishment on a representative TI. No feldspar markers remained after 6 months.



Figure 8.5. Degraded remains of a feldspar marker within a few months of placement. By six months these markers could not be located.

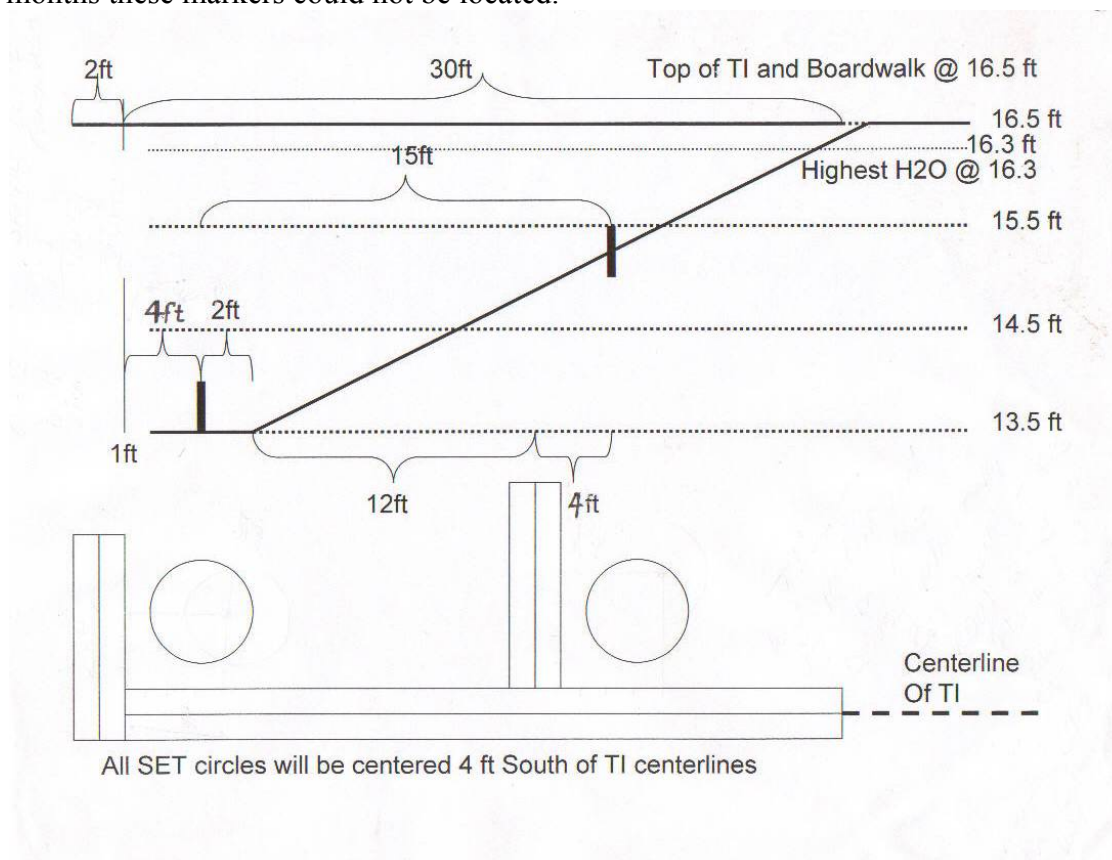

Figure 8.6. Generalized diagram of SET location and boardwalk layout on the tails of each of the eight tree islands.



Figure 8.7. Georectified locations of SETs using M1 tree islands as an example. One SET is located on the “wet” side slope (upper in figure) and one is located on the highest elevation area of each tree island in the highest density plantings. Two other SETs are located in line with the tree island center at midslope and on the slough bottom of tree island tails.



Figure 8.8. Aerial image showing SET boardwalks on one of the tree islands.

Table 8.2. M1WHH SET pin measurements from tree island M1W, head location, high elevation showing pin measurements in cm (± 0.1 cm) for each of 4 radial arm positions (as denoted by compass direction of arm)

Pin #	Direction			
	290 NW	20 NE	110 SE	200 SW
	Cm			
1	22.9	22.9	21.6	22.0
2	23.2	22.4	21.6	21.9
3	22.6	22.3	21.4	21.8
4	22.4	22.0	22.7	21.8
5	22.3	21.9	23.0	21.4
6	22.3	22.0	22.1	21.4
7	22.4	22.2	22.5	21.3
8	22.3	21.9	22.4	21.0
9	22.7	22.2	22.4	21.2

Figure 8.9. Photograph of feldspar marker under water and largely covered by flocculent detrital material immediately after placement.

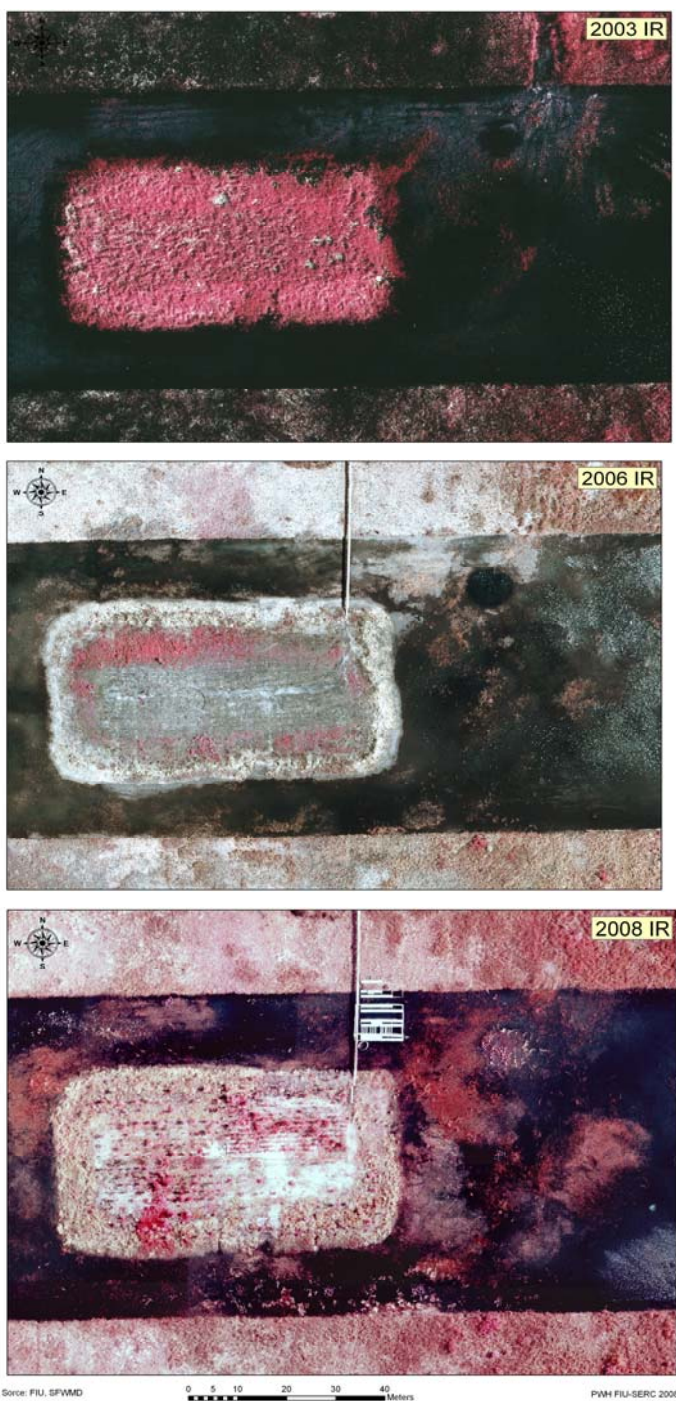

Figure 8.10. Time series of aerial photographs of tree island M2W showing increasing vegetation accumulation in the “tail” area.

9. Task 7. Site Coordination and Public Outreach

Task 7 Deliverables included attending coordination meetings with the SFWMD (7a), the preparation of annual and semi-annual reports (7b – g), conducting monthly conference calls (7h), facilitation of community involvement as opportunities warrant, and update kiosk and site literature (7j).

We have continuously attended the LILA Science coordination meetings, held approximately 4 times per year since the project began. We are continually in contact with SFWMD project management and have maintained close, professional relationships with SFWMD personnel as well as researchers from other institutions. To date we have produced 5 annual reports (including this one) and 4 semi-annual reports. We have been actively involved in promoting LILA to the larger scientific and public communities through numerous tours, 4 years of annual “Everglades Days”, the representation of LILA information at scientific meetings such as the Greater Everglades Ecosystem Restoration (GEER) meetings where several published abstracts have been presented (see below). Additionally, we assisted in producing LILA-based “Splash sheets” that are available as handout at the LILA kiosk and contain updated information about the activities at LILA, and have represented LILA in educational, and demonstration materials (video presentations) on display at the A.R. M. Loxahatchee National Wildlife Refuge Visitors Center.

Published abstracts include:

Cline, E., 2006. A review of research conducted at the Loxahatchee Impoundment Landscape Assessment (LILA) Project. P. 35. *In* 2006 Greater Everglades Ecosystem Restoration Conference. Lake Buena Vista, FL, USA. 5-9 Jun. 2006. USGS.

Scinto, L.J., R. Price, M. Ross, and E. Cline, Future plans and designs for research to be conducted at the Loxahatchee Impoundment Landscape Assessment (LILA) Project. P. 205. *In* 2006 Greater Everglades Ecosystem Restoration Conference. Lake Buena Vista, FL, USA. 5-9 Jun. 2006. USGS.

Cline, E. A review of research conducted at the Loxahatchee Impoundment Landscape Assessment (LILA) project” National Conference on Ecosystem Restoration (NCER), April 23-27, 2007 in Kansas City, MO.