

**HYDROGEOLOGIC INVESTIGATION OF
FLORIDAN AQUIFER SYSTEM AT L-2 CANAL SITE
HENDRY COUNTY, FLORIDA**

Technical Publication WS-3

Michael W. Bennett, P.G.

May 2001



South Florida Water Management District
3301 Gun Club Road
West Palm Beach, FL 33306
(561) 686-8800
www.sfwmd.gov



EXECUTIVE SUMMARY

The Lower West Coast (LWC) Planning Area includes Collier and Lee Counties and portions of Hendry, Charlotte, and Glades Counties in South Florida. A combination of natural drainage basins and political boundaries defines the extent of this planning area. Water supply plans developed for the LWC Planning Area have identified the Floridan Aquifer System (FAS) as a possible water supply alternative. Based on these plans, the South Florida Water Management District (SFWMD or District) initiated a program of exploratory well construction, aquifer testing, and long-term monitoring (water quality and potentiometric heads) to provide data needed to assess the FAS underlying this area.

This report documents the results of three Floridan aquifer test wells constructed and tested under the direction of the District. These wells are located south of the City of Clewiston, near the District's G-150 water control structure on the L-2 Canal in Hendry County. This site was selected to augment existing data and provide broad, spatial coverage within the District's LWC Planning Area.

The scope of the investigation consisted of constructing and testing three FAS wells. The first well (L2-TW) was drilled to a total depth of 2,235 feet below land surface (bls). It was completed into a single distinct hydrogeologic zone within the middle Floridan aquifer between 1,400 and 1,810 feet bls. The second well (L2-PW1) is located 262 feet south of the monitor well (L2-TW) and constructed to corresponding depths to facilitate aquifer testing. At a later date, a third well (L2-PW2) was completed in the upper Floridan aquifer between 810 and 1,150 feet bls.

The main findings of the exploratory drilling and testing program at this site were as follows:

- The top of the Floridan aquifer was identified at a depth of approximately 780 feet bls (as defined by the Southeastern Geological Society Adhoc Committee on Florida Hydrostratigraphic Unit Definition [1986]).
- Based on formation samples and geophysical logs, the Suwannee Limestone of Oligocene age was not identified in the subsurface at this site.
- Lithologic and geophysical logs, specific capacity and packer test results, and petrophysical data indicate limited production capacity of the upper Floridan aquifer. The results of a step-drawdown test on the upper Floridan aquifer (810 to 1,160 feet bls) yielded 6.25 gallons per minute (gpm) per foot of drawdown at a pump rate of 300 gpm.
- Water quality data from reverse-air returns and straddle packer tests indicate that chloride and total dissolved solids (TDS) in the upper Floridan aquifer waters exceed potable drinking water standards. Chloride and TDS concentrations range from 450 to

1,000 milligrams per liter (mg/L) and 1,300 to 2,400 mg/L, respectively.

- The production interval in the middle Floridan aquifer from 1,400 to 1,810 feet bls yielded a transmissivity value of 10,150 gallons/day/foot, a storage coefficient of 1.2×10^{-4} , and a leakage factor (r/B) value of 0.06, with a calculated leakance of 5.3×10^4 gpd/ft³.
- The base of the Underground Source of Drinking Water (USDW), those waters having TDS concentrations less than 10,000 mg/L, occurs at an approximate depth of 2,050 feet bls.
- Reverse-air discharge rates and fluid-type (flowmeter and temperature) geophysical logs show that the majority of natural flow occurs below the base of the USDW, at a depth of 2,070 feet. This flow coincides with the fractured and cavernous dolostones identified as the upper dolostone unit of the lower Floridan aquifer.
- The average measured potentiometric head for the Floridan aquifer monitoring interval (1,400 to 1,810 feet bls) is 57.9 feet mean sea level (msl) (NGVD, 1929) with maximum variations of ± 2 feet. Water levels in the Floridan aquifer respond to external stresses, such as tidal loading and barometric pressure variations.

TABLE OF CONTENTS

Executive Summary i

List of Figures v

List of Tables vii

Acknowledgements ix

Introduction 1

Exploratory Drilling and Well Construction 2

Hydrogeologic Testing Methods and Results 10

Hydrogeology 28

Summary 33

References 35

Appendix A: Geophysical Logs A-1

Appendix B: Lithologic Description B-1

Appendix C: Packer Test Drawdown and Recovery Data C-1

Appendix D: Petrophysical Data D-1

Appendix E: Petrologic Data: Photomicrographs E-1

LIST OF FIGURES

Figure 1. Project Location Map and Site Plan with Detailed Well Locations	1
Figure 2. Well Completion Diagram, Monitor Well (L2-TW)	3
Figure 3. Well Completion Diagram, Production Well No. 1 (L2-PW1)	8
Figure 4. Well Completion Diagram, Production Well No. 2 (L2-PW2)	11
Figure 5. Lithostratigraphic Column	12
Figure 6. Water Quality with Depth -- Reverse-Air Fluid Returns	13
Figure 7. Deuterium versus Oxygen-18 Cross-Plot	19
Figure 8. Core Porosity versus Permeability Cross-Plot	21
Figure 9. Core Porosity versus Depth	21
Figure 10. Aquifer Performance Test -- Well Configuration	23
Figure 11. Time Series Plot of Drawdown Data -- Production Well No. 1 (L2-PW1)	24
Figure 12. Time Series Plot of Drawdown Data -- Monitor Well (L2-TW)	24
Figure 13. Time Series Plot of Pumping Rates during Aquifer Performance Test	25
Figure 14. Time Series Plot of Recovery Data -- Production Well No. 1 (L2-PW1)	25
Figure 15. Time Series Plot of Recovery Data -- Monitor Well (L2-TW)	26
Figure 16. Log-Log Plot of Drawdown versus Time -- Monitor Well (L2-TW)	27
Figure 17. Long-Term Hydrograph -- Monitor Well (L2-TW)	28
Figure 18. Hydrogeologic Section Underlying L-2 Canal Site	29
Figure A-1. Geophysical Log Run No. 1 (L2-TW)	A-3
Figure A-2. Geophysical Log Run No. 2 (L2-TW)	A-4
Figure A-3. Geophysical Log Run No. 1 (L2-PW1)	A-5
Figure A-4. Geophysical Log Run No. 1 (L2-PW2)	A-6
Figure A-5. Geophysical Log Run No. 2 (L2-PW2)	A-7

LIST OF TABLES

Table 1.	Summary of Geophysical Logging Operations	14
Table 2.	Packer Test Results from L-2 Canal Drill Site, Hendry County, Florida.....	17
Table 3.	Stable Isotope and Carbon-14 from L-2 Canal Drill Site, Hendry County, Florida.....	18
Table D-1.	Core Analysis Results for L-2 Canal Drill Site, Hendry County, Florida D-14	
Table E-1.	Summary of Petrologic Analyses	E-3

ACKNOWLEDGEMENTS

The author gratefully acknowledges the many people who aided in the successful completion of this project. I would like to thank those outside the District who reviewed the manuscript or lent technical expertise to the writing of the report. They include Ron Reese, P.G., of the United States Geological Survey and Dr. Charles (Buzz) Walker of Missimer International/CDM.

Appreciation is also extended to the technical and professional staff of the South Florida Water Management District who assisted in the compilation and analysis of data and the production of this report. They include Linda Lindstrom, John Lukasiewicz, Robert Verrastro, Richard Bower, Steven Anderson, and Edward Rectenwald. I appreciate Janet Wise for her graphics capabilities. I thank Felicia Berger and Victor Mullen for their editorial assistance and expertise in bringing this document to publication.

INTRODUCTION

Background

The Lower West Coast (LWC) Planning Area includes Collier and Lee Counties and portions of Hendry, Charlotte, and Glades Counties in South Florida. A combination of natural drainage basins and political boundaries defines the extent of this planning area. Water supply plans developed for the LWC Planning Area have identified the Floridan Aquifer System (FAS) as a possible water supply alternative. Based on these plans, the South Florida Water Management District (SFWMD or District) initiated a program of exploratory well construction, aquifer testing, and long-term monitoring (water quality and potentiometric heads) to provide data needed to assess the FAS underlying this area. These wells will supply information needed to characterize the water supply potential of the FAS and support the development of a groundwater flow model, which will be used in future planning and regulatory decisions. The first site selected under this program was on a District-owned right-of-way proximal to the L-2 Canal located in the Northwest Quarter of Section 4, Township 45 South, Range 34 East, in eastern Hendry County (**Figure 1**).

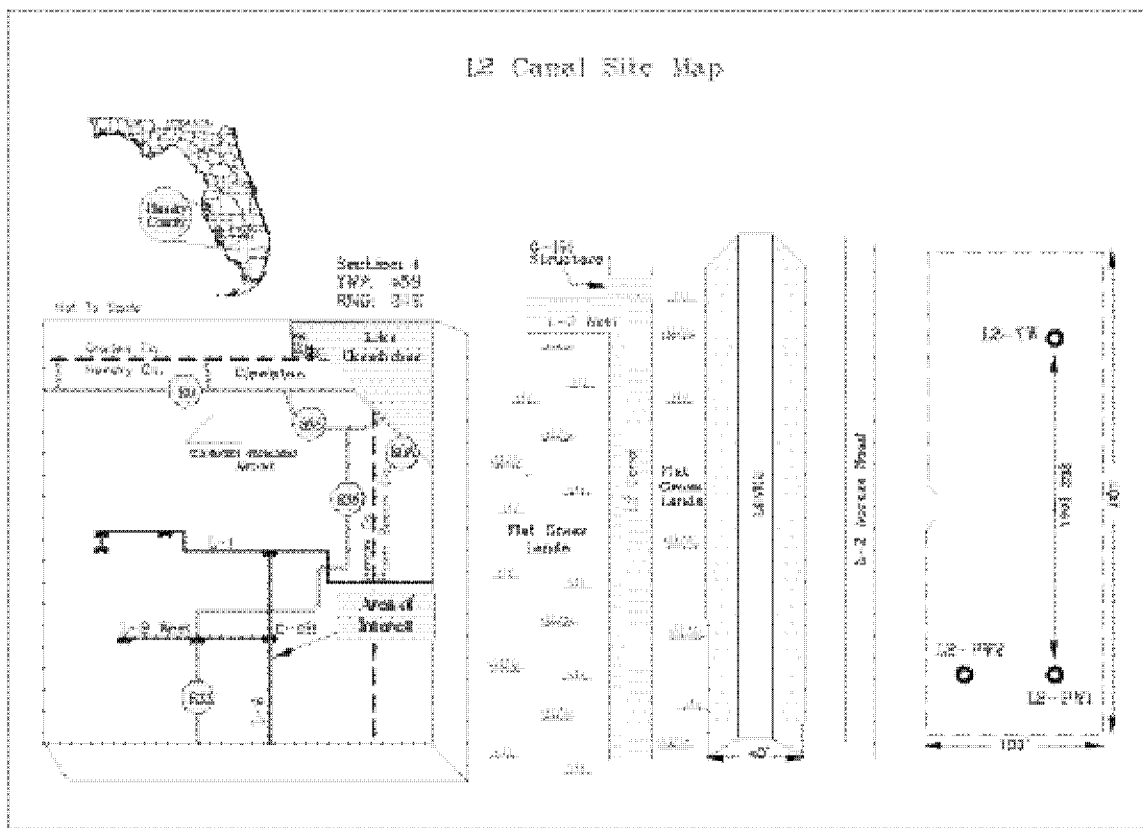

Figure 1. Project Location Map and Site Plan with Detailed Well Locations

Purpose

The purpose of this report is to document the hydrogeologic data collected during the District-initiated well drilling and aquifer testing program at the L-2 Canal site. This report includes a summary of: (1) well drilling and construction details, (2) hydrogeology, (3) water quality and productive capacity, (4) stable isotope and carbon-14 data, (5) petrophysical and petrologic data, (6) aquifer performance test data and analyses, and (7) long-term, potentiometric head data.

Project Description

Three wells were constructed as part of this project. The first Floridan aquifer well (L2-TW) was drilled to a total depth of 2,235 feet below land surface (bls). It was completed into a single distinct hydrogeologic zone within the middle Floridan aquifer between 1,400 and 1,810 feet bls. The second well (L2-PW1) is located 262 feet south of the monitor well (L2-TW) and constructed to corresponding depths to facilitate aquifer testing. The third well (L2-PW2) was completed in the upper Floridan aquifer between 810 and 1,150 feet bls. Youngquist Brothers Inc. (YBI) of Fort Myers, Florida, was selected as the lowest cost, most responsive and qualified contractor to perform the well drilling, construction, and testing services. District Contract C-4172 was executed on May 24, 1993, and YBI was issued a Notice to Proceed on November 22, 1993. Construction of the Floridan aquifer monitor well at the L-2 Canal site began on December 15, 1993.

EXPLORATORY DRILLING AND WELL CONSTRUCTION

L-2 Canal Floridan Aquifer Exploratory/Monitor Well

On November 22, 1993, drilling and support equipment was delivered to the L-2 Canal drill site to facilitate drilling and construction of the Floridan aquifer monitor well (L2-TW). After minor clearing and rough grading the site, the ground surface beneath the drill rig and settling tanks was lined with a buried impermeable 7-millimeter thick plastic liner. A 2-foot thick temporary drilling pad was then constructed using crushed limestone. A 2-foot high earthen berm was constructed around the perimeter of the rig and settling tanks to contain drilling fluids and/or formation waters produced during well drilling, testing, and well construction activities.

Drilling of the pilot hole began on December 15, 1993. Both mud-rotary and reverse-air techniques were used during drilling operations. The mud-rotary method was used to drill the pilot hole from land surface to a depth of 790 feet bls. The pilot hole from 790 to 2,235 feet bls was drilled using the reverse-air method. A completion diagram of the L-2 Canal Floridan aquifer monitor well, identified as L2-TW, is shown in **Figure 2**.

Lithologic (well cuttings), packer test, and borehole geophysical log data were used to determine the actual casing setting depths. The pilot hole was then reamed to specified

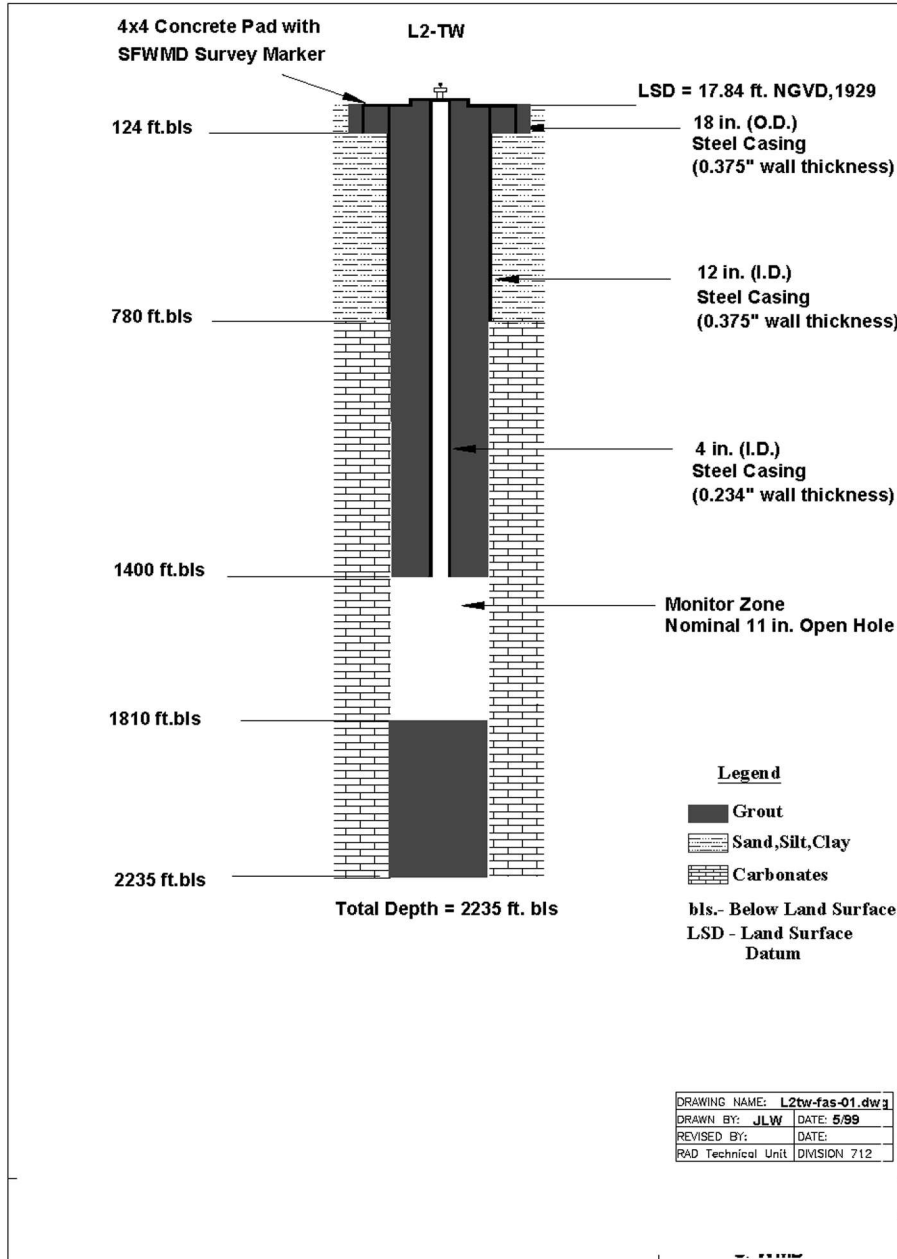

Figure 2. Well Completion Diagram, Monitor Well (L2-TW)

diameters for the selected casing setting. Three concentric steel casings (18-, 12-, and 4-inch diameter) were used in the construction of the Floridan aquifer monitor well.

A 9½-inch diameter pilot hole was initially advanced to a depth of 135 feet bls. The pilot hole was reamed to a diameter of 23 inches to a depth of 120 feet bls, and caliper logged to verify depths and calculate cement volumes for subsequent cement grouting operation. A nominal 18-inch diameter, steel surface casing (ASTM A53, Grade B, 0.375-inch wall thickness) was then installed. The annulus for the surface casing was pressure grouted using 165 cubic feet (ft³) of ASTM Type II neat cement, bringing cement levels to land surface. The purpose of the surface casing is to prevent unconsolidated surface sediments from collapsing into the drilled hole, isolate the surficial aquifer from brackish water contamination, and provide drill rig stability during continued drilling operations.

With the surface casing installed, the pilot hole was advanced using the closed circulation mud-rotary drilling method through the unconsolidated to semi-consolidated Pliocene-Miocene aged sediments. Drilling operations through these sediments were completed to a depth of 790 feet bls on December 30, 1993. That same day, Florida Geophysical Logging Service Inc. ran a suite of geophysical logs within the 9½-inch diameter pilot hole from 120 to 790 feet bls. The logging suite consisted of the following logs: x-y caliper, natural gamma, spontaneous potential (SP), dual induction/laterolog resistivity log (LL3) combination, borehole compensated sonic, and compensated neutron-density. The individual log traces from Geophysical Log Run No. 1 are presented in **Appendix A**. Water production or fluid-type logs (e.g., pumped flowmeter) were not run due to the poorly consolidated nature of the sediments within this interval, requiring the drilling fluids to remain in place to ensure borehole stability during logging operations.

Lithologic and geophysical log data from the 120 to 790 feet bls interval were reviewed to determine a casing-setting depth for the intermediate casing. The intermediate casing was designed to provide borehole stability during subsequent reverse-air drilling operations within the Floridan aquifer. After identifying the base of the Hawthorn Group at 780 feet bls, the pilot hole was reamed to a depth of 785 feet bls and caliper logged to verify depths and calculate cement volumes for grouting operations. A nominal 12-inch diameter, steel casing (ASTM A53, Grade B, 0.375-inch wall thickness) was then installed in the 17-inch diameter borehole to a depth of 780 feet bls. The annulus was pressure grouted using 495 ft³ of ASTM Type II cement, bringing cement levels to 200 feet bls. An additional 175 ft³ of neat cement was pumped by the tremie method, causing cement returns at land surface.

Reverse-air drilling operations began on January 12, 1994 and were used to advance the pilot hole through the Floridan aquifer from 790 to a total depth of 2,235 feet bls. The reverse-air drilling method was chosen because it provides high quality lithologic samples and reduces the potential for formation damage (pore clogging) by invading drilling fluids. It also provides a drilling method that can be continued through highly permeable zones (e.g., lost circulation horizons, well documented throughout the Floridan aquifer).

A nominal 11-inch diameter reverse-air pilot hole was drilled from 790 to 2,057 feet bls without significant problems through the upper Eocene Ocala Limestone and a portion of the middle Eocene Avon Park Formation. However, drilling rates slowed between 2,057 and 2,140 feet bls, with minor drops of 1 to 2 feet of the drill rod, indicating potential cavernous intervals within a predominately dolostone sequence. Also, while drilling through this interval, the reverse-air discharge rates increased and the circulated return fluids began to foam. These two observations indicated that a highly permeable horizon containing formation water of poor quality (elevated sodium chloride and total dissolved solids [TDS] concentrations) was present within this interval. The remaining portion of the pilot hole from 2,140 to 2,235 feet bls drilled without incident through predominantly well-indurated dolostone to a total depth of 2,235 feet bls and was completed on January 27, 1994.

Upon completion of the pilot hole, Florida Geophysical Logging Services ran a second suite of geophysical logs in the 11-inch diameter reverse-air borehole from 742 to 2,235 feet bls on January 28, 1994. The logging suite consisted of the following logs: x-y caliper, natural gamma, SP, dual induction/LL3 combination, borehole compensated sonic, and compensated neutron-density. Production type logs included a high-resolution temperature (gradient and differential) and flowmeter conducted under both static (nonpumping) and dynamic (artesian flow) conditions. While logging this interval, difficulties were encountered near the top of the dolostone horizon at 2,060 feet bls, below which most of the logging sondes could not be lowered due to the highly irregularly shaped borehole. The x-y caliper and natural gamma sonde (first sonde ran) was the only sonde to navigate past the dolostone unit at 2,060 feet bls and record information on the entire open-hole section of the pilot hole. The individual log traces from Geophysical Log Run No. 2 are presented in **Appendix A**.

Using the information provided by the geophysical logs and well cuttings, straddle-packer test intervals were selected, and the first of five tests began on February 1, 1994. The purpose of these tests was to characterize the water quality and production capacities of specific intervals within the larger open-hole interval (780 to 2,235 feet bls). From a water resource perspective, intervals having TDS concentrations greater than 10,000 milligrams per liter (mg/L) were not considered for further aquifer hydraulic characterization or long-term monitoring because they are not considered potential sources of drinking water, as defined in Chapter 62-520 of the Florida Administrative Code. The Underground Source of Drinking Water (USDW) is defined as an aquifer containing water with a TDS concentration of less than 10,000 mg/L. A set of five packer tests was completed on February 9, 1994, and the water quality data obtained were used in tandem with the geophysical logs to identify the base of the USDW at 2,050 feet bls.

With the base of the USDW identified at an approximated depth of 2,050 feet bls and a transition zone of poor water quality occurring from 1,850 to 2,050 feet bls, the pilot hole was back-plugged to 1,810 feet bls. While back-plugging the pilot hole, large volumes of cement slurry were pumped into the fractured/cavernous section between 2,057 and 2,130 feet bls. A combination of 3/8-inch diameter crushed limestone and hydrated neat cement was used to bridge this interval. Once this interval was bridged, back plugging of the pilot hole continued to a depth of 1,810 feet bls. Twenty-two (22) yd³

of 3/8-inch diameter crushed limestone and 815 ft³ of 12 percent bentonite-cement slurry were used in back-plugging operations.

Once back-plugging operations were completed to a depth of 1,810 feet bls, all available information was used to select the upper limit of the open-hole section for the Floridan aquifer monitor well. A review of the lithologic data, geophysical logs, and packer tests results indicated that the proposed monitor horizon from 1,400 to 1,810 feet bls would be moderately productive. Composite water samples collected during packer testing (1,442 to 1,704 feet bls) indicated that TDS concentrations were between 1,370 and 2,160 mg/L. The flowmeter and temperature logs indicated diffuse production over the interval between 1,400 and 1,810 feet bls. Based on this information, a depth of 1,400 feet bls was selected as setting depth for the 4-inch diameter final casing. The nominal 11-inch diameter pilot hole provided the annular space needed to properly install and grout the nominal 4-inch diameter steel casing (ASTM A53, Grade B, 0.237-inch wall thickness). The pilot hole was caliper logged to verify depths and calculate cement volumes for subsequent grouting operation. Three steel cement baskets were attached to the 4-inch diameter casing at 1,385, 1,390, and 1,395 feet bls. The 4-inch diameter casing was cement grouted to land surface by the tremie method in 11 stages with 1,215 ft³ of 12 percent bentonite-cement slurry.

A well head was installed on top of the 4-inch diameter casing flange. It consisted of a 4-inch diameter stainless steel gate valve with a 3/4-inch diameter side port. A 4x4-foot concrete pad was constructed at the base of the monitor well, completing well construction operations on March 13, 1994.

Demobilization of the drilling and support equipment, and site restoration, were completed on March 17, 1994. Upon completion of site restoration at the L-2 Canal site, YBI withdrew from the contract. The remaining scope of work related to District Contract C-4172 was assigned to RST Enterprises, Fort Myers, Florida, on April 6, 1994.

L-2 Canal Floridan Aquifer Test Production Well No. 1

Drilling and support equipment was mobilized to the L-2 Canal site on June 13, 1995 to begin drilling the Floridan aquifer test production well (L2-PW1). This well was constructed to stress the interval between 1,400 to 1,810 feet bls and provide the second of a two-well set needed to conduct composite hydraulic testing operations within the Floridan aquifer. Drilling operations began on June 20, 1995, with Parker Well Drilling providing drilling and well construction subcontracting services to RST Enterprises, Inc. The ground surface beneath the drill rig and settling tanks was lined with a buried impermeable 7-mil thick plastic liner. A 2-foot thick temporary drilling pad was constructed using crushed limestone. A 2-foot high earthen berm was constructed around the perimeter of the rig and settling tanks to contain drilling fluids and/or formation waters produced during well drilling, testing, and well construction.

Four concentric steel casings (24-, 18-, 12-, and 8-inch diameter) were used in the construction of the Floridan aquifer test production well. A 20-foot, 24-inch diameter steel

pit casing was first installed. A nominal 24-inch diameter bit was used to advance the borehole using the mud-rotary drilling method from 20 to 810 feet bls. The nominal 24-inch borehole was caliper logged to verify depths and used to calculate cement volumes for subsequent grouting operations. The intermediate casing was installed to a depth of 800 feet bls, consisting of nominal 18-inch diameter steel pipe (ASTM A53, Grade B, 0.375-inch wall thickness). Once installed, the 18-inch diameter casing was pressure grouted using 300 ft³ of Type II neat cement. Additional stages of neat cement were placed using the tremie method with each stage being hard tagged. Successive cement stages were used to complete the grouting of the 18-inch diameter casing annulus back to land surface. Installation of the 18-inch diameter steel casing was completed on July 25, 1995.

Mud-rotary drilling was used to continue the borehole using a 14-inch diameter bit to a depth of 1,400 feet bls. The borehole was then caliper logged by RST Enterprises before setting the production casing. During the drilling from the 810 to 1,400 feet bls, three representative 4-inch whole-diameter rock cores were obtained. These cores were sent to Core Laboratories in Midland, Texas for detail petrophysical and petrologic analyses (refer to Petrophysical — Petrologic Section for further information).

The production casing consisted of both 8- and 12-inch diameter steel casings. The upper 300 feet of the production casing was constructed using nominal 12-inch diameter steel pipe, reduced to 8-inch diameter steel pipe for the lowermost 1,100 feet. The 1,400 feet of production casing was installed and grouted to land surface with neat cement using both pressure and tremie type methods. A total of 1,500 ft³ of ASTM C-150, Type II neat cement was used to grout the production casing annulus. The open-hole section (1,400 to 1,810 feet bls) of the test production well was drilled by using the mud-rotary method with a nominal 8-inch diameter bit. Four whole-diameter rock cores (4-inch diameter) were obtained from the production interval (1,400 to 1,810 feet bls – Avon Park Formation). These cores were also sent to Core Laboratories in Midland, Texas for petrophysical and petrologic analyses (refer to Petrophysical — Petrologic Section for further information). Drilling of the production interval was completed on October 5, 1995.

Once the production interval was drilled, well development began using both induced compressed air and natural artesian flow methods. This process continued until the formation waters were clear and free of particulate matter. Once developed, RST Enterprises provided geophysical logging services for the 1,400 to 1,810 foot bls open-hole section. The logging suite consisted of the following logs: 3-arm caliper, natural gamma, SP, 16/64-inch normal resistivity, 6-foot lateral resistivity, temperature, and fluid resistivity (**Appendix A**).

A standard 12-inch diameter well head was installed consisting of an iron body, bronze-mounted valves with flanged ends, solid wedge gate, and outside screw and yoke gate valves. A 4x4 foot concrete pad was built at the base to complete the construction of the test production well. Well construction activities were completed on October 15, 1995. A completion diagram of the L-2 Canal Floridan aquifer test production well (L2-PW1) is shown in **Figure 3**.

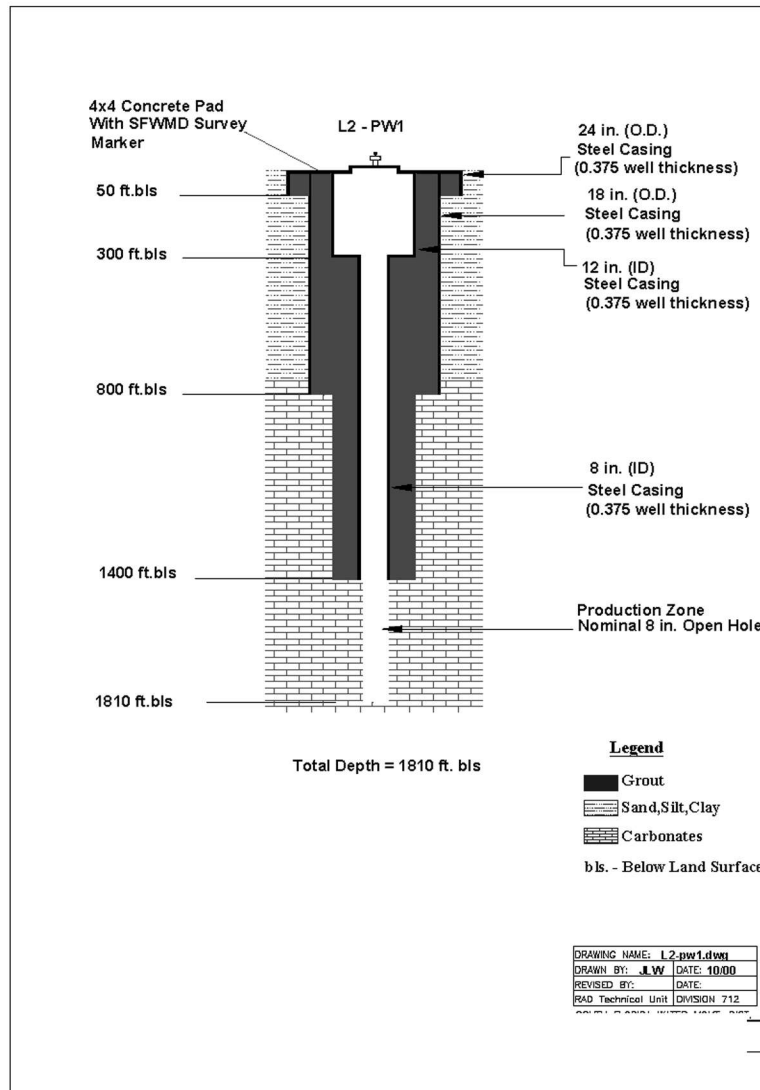

Figure 3. Well Completion Diagram, Production Well No. 1 (L2-PW1)

L-2 Canal Floridan Aquifer Test Production Well No. 2

Under an amendment to District Contract C-7663, a second Floridan aquifer test production well was construction at the L-2 Canal site. On May 28, 1999, drilling and support equipment arrived at the L-2 Canal to begin drilling an upper Floridan aquifer test production well (L2-PW2). This well was constructed to obtain production, water quality, and water level information on an interval between 810 to 1,160 feet bls. A drilling pad was constructed using crushed limestone with an earthen berm built around the perimeter of the rig and settling tanks. The drilling pad was constructed to contain drilling fluids and/or formation waters produced during well drilling, testing, and well construction.

Diversified Drilling Corporation (DDC) of Tampa, Florida began drilling operations on June 6, 1999. Two concentric steel casings (18- and 12-inch diameter) were used in the construction of the second Floridan aquifer test production well. A nominal 23-inch diameter bit was used to advance the borehole using mud-rotary from land surface to 135 feet bls. The nominal 23-inch borehole was caliper logged to verify depths and was used to calculate cement volumes for subsequent grouting operations. The surface casing was installed to a depth of 132 feet bls, consisting of nominal 18-inch diameter steel pipe (ASTM A53, Grade B, 0.375-inch wall thickness). Once installed, the 18-inch diameter casing was pressure grouted to land surface using 189 ft³ of Type II neat cement. Installation of the 18-inch diameter surface casing was completed on June 9, 1999.

With the surface casing installed, a nominal 17-inch diameter borehole was advanced using the closed circulation mud-rotary drilling method to a depth of 926 feet bls. On June 23, 1999, MV Geophysical Logging ran a suite of geophysical logs within the 17-inch diameter borehole from land surface to 926 feet bls. The logging suite consisted of the following logs: x-y caliper, natural gamma, SP, and a dual induction with a shallow normal resistivity log. The individual log traces from Geophysical Log Run No. 1 for L2-PW2 are presented in **Appendix A**.

Lithologic and geophysical log data from the 130 to 926 feet bls interval were reviewed to determine a casing-setting depth for the production casing. After identifying the base of the Hawthorn Group at 785 feet bls, and little evidence of production near the top of the Ocala Limestone, a setting depth of 810 feet bls was selected for the production casing. The borehole was then back-filled to 805 feet bls using 3.5 yd³ of 3/8-inch diameter crushed limestone. The borehole was reamed using a staged bit reamer to a depth of 813 feet bls, and caliper logged to verify depths and calculate cement volumes for the grouting operation. The nominal 12-inch diameter, steel casing (ASTM A53, Grade B, 0.375-inch wall thickness) was installed in the 17 5/8-inch diameter borehole to a depth of 810 feet bls. The annulus was pressure grouted using 567 ft³ of ASTM Type II cement, bringing cement levels to 40 feet bls. An additional 30 ft³ of neat cement was pumped by the tremie method, creating cement returns at land surface. Installation of the 12-inch diameter production casing was completed on July 1, 1999.

Once the production casing was installed, drilling operations resumed on July 6, 1999. The cement plug was drilled out, the backfill material removed, and the borehole advanced through the Floridan aquifer from 926 feet bls to a total depth of 1,160 feet bls. Drilling of the production interval (810 to 1,160 feet bls) was completed on July 8, 1999. The production interval was developed by both airlift and artesian flow methods and geophysically logged by MV Geophysical on July 9, 1999. The logging suite consisted of the following logs: x-y caliper, natural gamma, SP, and a dual induction with a shallow resistivity log. Production type logs included a temperature, fluid resistivity, flowmeter, and borehole video survey. Due to significant particulate material within the fluid column, the flowmeter and video logs were rerun on July 14, 1999. The individual log traces from Geophysical Log Run No. 2 are presented in **Appendix A**.

A standard 12-inch diameter well head was installed consisting of an iron body, bronze-mounted valves with flanged ends, and an outside yoke gate valve. A 4x4 foot concrete pad was built at the base to complete the construction of the test production well. Well construction activities were completed on July 25, 1999. A completion diagram of the L-2 Canal Floridan aquifer test production well (L2-PW2) is shown in **Figure 4**. Once the test production well was completed, a specific capacity test was conducted, which yielded 6.25 gpm/ft of drawdown at a discharge rate of 300 gpm.

HYDROGEOLOGIC TESTING METHODS AND RESULTS

Specific information was collected during the drilling program to determine the lithologic, hydraulic, and water quality characteristics of the FAS at this site. These data were to be used to design the Floridan aquifer monitor and test production wells for use in a site-specific aquifer test and for long-term water level and quality monitoring.

Formation Sampling

Geologic formation samples (well cuttings) were collected, washed, and described (using Dunham classification scheme, 1962) onsite during the drilling of the pilot hole. Formation samples were collected continuously and separated based on their dominant lithologic or textural characteristics, and to a lesser extent, color. If a massively bedded unit was encountered, composite samples were taken at 5-foot intervals. The representative formation samples were split into two sets and distributed to the District and the Florida Geological Survey (FGS).

The lithostratigraphic column, shown in **Figure 5**, was constructed using both the District's onsite drilling log and lithologic descriptions provided by the FGS. A copy of the FGS's detailed lithologic description for the pilot hole/monitor well (FGS Reference No. W-17093) is provided in **Appendix B**. An electronic version of the lithologic description can be downloaded directly from FGS's internet site: www.dep.state.fl.us/geo/data/litholog.htm.

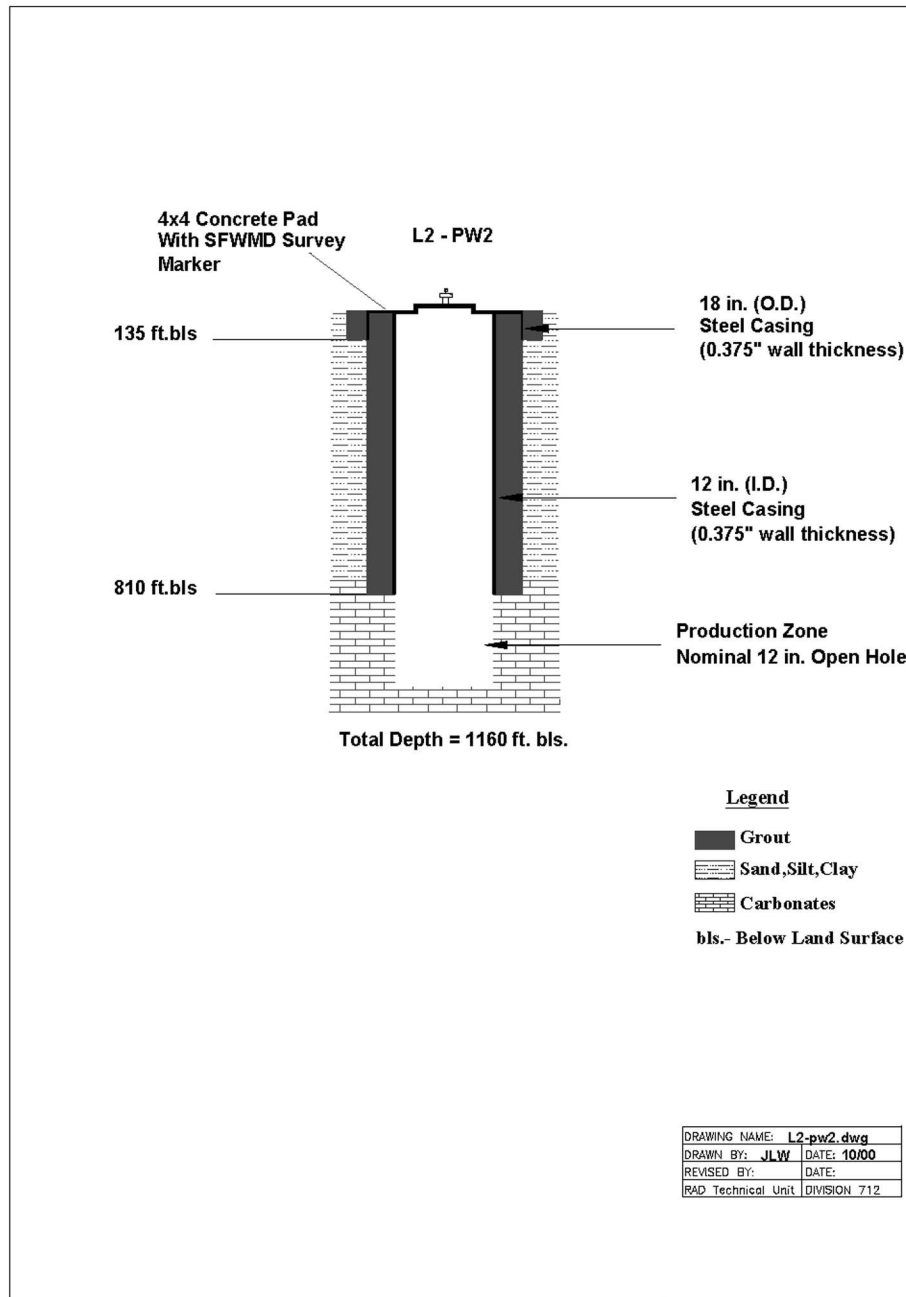

Figure 4. Well Completion Diagram, Production Well No. 2 (L2-PW2)

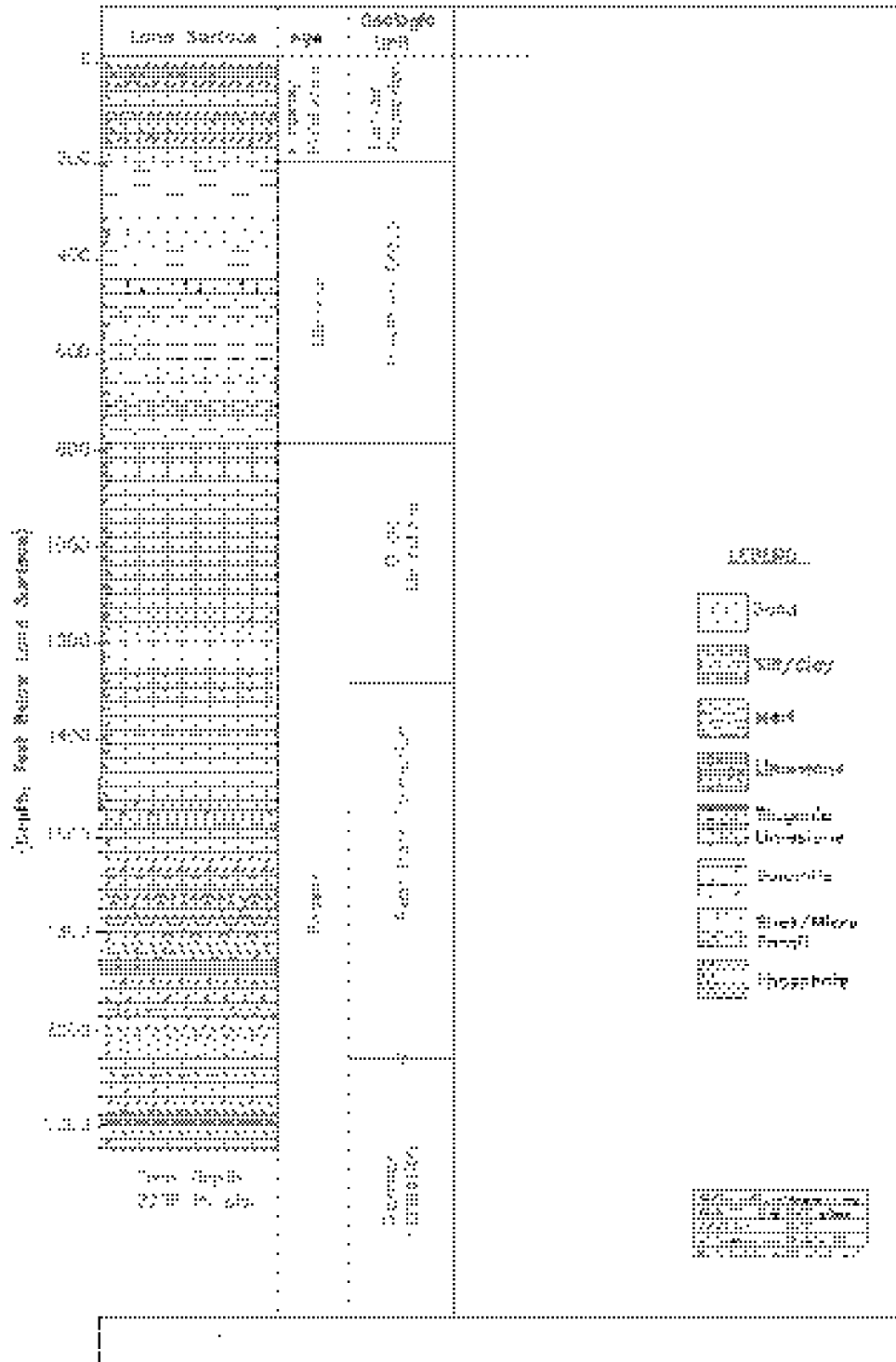

Figure 5. Lithostratigraphic Column

Formation Fluid Sampling

During reverse-air drilling operations, samples of the circulated return fluids (composite formation water) were collected every 30 feet (average length of drill rod) starting at a depth of 836 feet bls and extending to the total depth of pilot hole at 2,235 feet bls. Field parameters that included temperature, specific conductance, and pH were determined on each sample using a Hydrolab multiparameter probe. Chloride concentrations were also determined using a field titration method (Hach Kit). **Figure 6** shows the values for each field parameter with respect to depth. As shown in the diagram, water quality remains fairly consistent between 800 to 1,830 feet bls with average specific conductance values and chloride concentrations of 2,700 microseimens and 900 mg/L, respectively. Below 1,830 feet bls, specific conductance and chloride concentrations begin to increase. A significant hydraulic and water quality change occurs at 2,060 feet bls. At this depth, conductance and chloride values show marked increases, as shown in **Figure 6**. Brackish to saline waters occur from this depth to the total depth of the well at 2,235 feet bls.

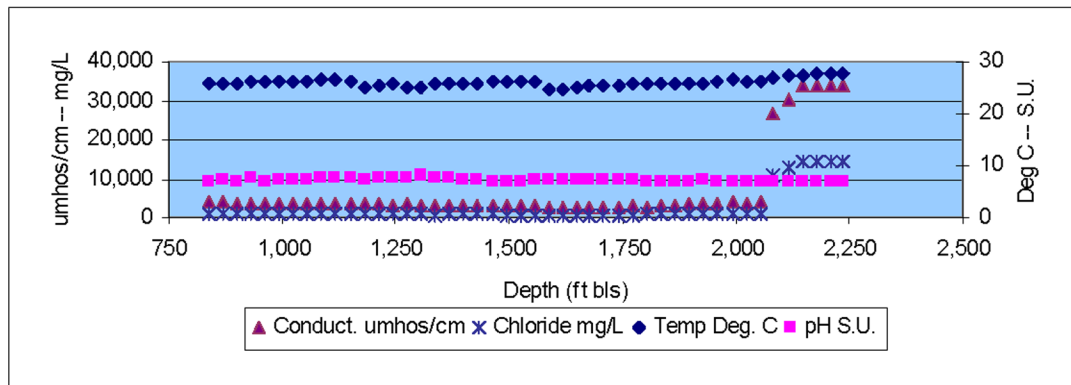

Figure 6. Water Quality with Depth -- Reverse-Air Fluid Returns

Geophysical Logging

Geophysical logs were run in the pilot hole after each stage of drilling and before reaming of the borehole for casing installations. These logs were run to provide a continuous record of the physical properties of the subsurface formations and their contained fluids. These logs were later used to: (1) assist in the interpretation of lithology, (2) provide estimates of permeability, porosity, bulk density, and resistivity of the aquifer, and (3) determine the salinity of the ground water. In addition, the extent and degree of confinement of discrete intervals can be discerned from the individual logs. All geophysical log data were downloaded directly from the onsite logging processor in log ASCII standard (LAS) Version 1.2 or 2.0 format. The District and local slimline logging firms provided supplemental geophysical logging services. The geophysical log traces for Well L2-TW, L2-PW1, and L2-PW2 are presented in **Appendix A**. The original geophysical logs and video surveys are archived and available for review at the District's headquarters in West Palm Beach, Florida.

A summary of the geophysical logging operations conducted at this site is listed in **Table 1**. The neutron and density porosities for both Run Nos. 1 and 2 for L2-TW were derived using a limestone matrix with a density of 2.71 grams per cubic centimeter (gm/cm³).

Table 1. Summary of Geophysical Logging Operations

Well Identifier	SFWMD Geophy-Log	Date	Run	Logging Company	Elevation (ft, NGVD)	Logged Interval (ft bls)	Caliper	Natural Gamma	SP	Induction	Density	Neutron	Sonic	Flow-Meter	Fluid Res	Temp	Video
L-2-TW	051-0000018	12/30/93	1	Florida Geophy.	17.35	120-742	x	x	x	x	x	x	x				
		01/28/94	2	Florida Geophy.	17.35	700-2236	x	x	x	x	x	x	x	x		x	
		02/25/94	3	Florida Geophy.	17.35	720-2010	x							x		x	x
L2-PW1	051-0000057	11/20/98	1	RST Enterprise	16.90	1400-1810	x	x						x	x		
L2-PW2	051-0000058	06/23/99	1	MV Geophysical	16.72	0-928	x	x	x	x							
		07/09/99	2	MV Geophysical	16.72	780-1160	x	x	x	x				x	x	x	x

Packer Testing

The straddle-packer pumping tests were limited to the open-hole section transecting the FAS (1,250 to 2,235 feet bls). The purpose of these tests was to: (1) gain water quality and production capacity data on discrete intervals (25 to 50 feet in length), and (2) establish the depth of the 10,000 mg/L TDS interface. No information could be gained from 780 to 1,250 feet because the reverse-air borehole exceeded the 18-inch diameter expansion limit of the nominal 12-inch diameter inflatable packers. The enlarged borehole above 1,250 feet was a consequence of upward flow during reverse-air drilling, swabbing action of the drill pipe, and well development, all of which eroded the poorly indurated limestones.

The procedures listed below were used to conduct individual packer tests in Well L2-TW at the L-2 Canal site:

1. Run packer assembly to the interval selected for testing based on geophysical and lithologic logs
2. Set and inflate packers and open the ports between the packers to the test interval
3. Install a 4-inch diameter submersible pump to depth of 60 to 120 feet below the drill floor with a pumping capacity of 200 gpm
4. Install one 100-psi pressure transducer inside the standpipe, and one 30-psi transducer in the annulus
5. Purge a minimum of three drill-stem volumes

6. Monitor pressure transducer readings and field water quality parameters (e.g., temperature, specific conductance, and pH) from the purged formation water until stable. These parameters were used to determine the quality of isolation of the “packed-off” interval
7. Perform the constant rate drawdown and recovery tests once the interval was effectively isolated
8. Collect representative formation water samples for laboratory water quality analyses following the District’s QA/QC sampling procedures (SFWMD, 1994)
9. Record recovery data until water levels return to static conditions.

Before ground water sampling, the packer intervals were purged until three borehole volumes were evacuated, or until field parameters of samples collected from the discharge pipe had stabilized. A limit of ± 5 percent variation in consecutive field parameter readings was used to determine chemical stability. The flow of water from the discharge point was adjusted to minimize the aeration and disturbance of the samples. Unfiltered and filtered samples were collected directly from the discharge point into a Teflon bailer. The bailer was then placed on a bailer stand where the sample bottles were filled slowly to minimize aeration. Duplicate samples were collected by sampling from consecutive bailers. Sample splits were collected from the same bailer.

Once samples were collected, the bottles were preserved and immediately placed on ice in a closed container and transported to the SFWMD’s water quality laboratory. The samples were then analyzed for major cation and anions, dissolved trace metals, and total organic carbon using EPA and/or Standard Method procedures (SFWMD, 1994).

The Hazen-Williams equation was used to calculate the friction (head) losses for all drawdown data because of induced flow up the drill pipe. These head losses were used to correct the drawdown data for specific capacity determinations. Curve-matching techniques were not used to determine transmissivity values from the drawdown or recovery data collected from straddle packer tests because they generally violate the analytical method’s basic assumptions, such as partial penetration, friction loss in small pipe, and short pumping period.

Packer Test No. 1 (2,075 to 2,124 feet bls): The purpose of this packer test was to achieve water samples for analyses and determine the interval’s production capacity. The main intent of this packer test was to use the water quality data to confirm the depth of the base of the USDW. This test was conducted on February 1, 1994, and consisted of pumping an interval between 2,075 and 2,124 feet bls (lower FAS with calculated TDS concentration $>10,000$ mg/L derived from the induction logs) in Well L2-TW. This interval was pumped for 2.25 hours at an average discharge rate of 75 gpm. The maximum measured drawdown while pumping was 12.5 feet, but the corrected drawdown was 5.0 feet with 7.5 feet due to friction loss. The specific capacity was calculated as 15 gallons per minute per foot of drawdown (gpm/ft) drawdown. A transmissivity of 30,000 gpd/ft

was estimated by multiplying the specific capacity by 2,000 (Fetter, 1988). The static water level after recovery was measured as 34.91 feet above the National Geodetic Vertical Datum of 1929 (NGVD) and was density corrected to an equivalent freshwater head of 65.95 feet NGVD. The land surface at the site was approximately 17.4 feet above NGVD. Water quality results indicated that the produced formation water exceeded the 10,000-mg/L TDS limit with a concentration of 19,100 mg/L. The results of the complete anion/cation analyses are listed in **Table 2**. Time-series plots (semi-log) of the drawdown and recovery data for Packer Test No. 1 are shown in **Appendix C**.

Packer Test No. 2 (1,890 to 1,910 feet bls): The purpose of this packer test was to identify the base of the USDW and determine the hydraulic properties of the lower intraquifer confining unit identified in the well cuttings and geophysical logs. An interval between 1,890 and 1,910 feet bls was selected, and a drawdown test was conducted on February 4, 1994. This interval was pumped for 3 hours at an average rate of 35 gpm. The static water level was measured at 52.17 feet NGVD (density corrected to a equivalent freshwater head of 60.29 feet NGVD). Maximum drawdown (corrected for friction loss) measured while pumping was 81.86 feet, and the specific capacity was calculated as 0.43 gpm/ft. Chlorides and TDS sampled from the zone were 3,084 and 5,550 mg/L, respectively. The results of the complete anion/cation analyses are reported in **Table 2**. Time-series plots (semi-log) of the drawdown and recovery data for Packer Test No. 2 are shown in **Appendix C**.

Packer Test No. 3 (1,266 to 1,286 feet bls): The purpose of this packer test was to determine the hydraulic properties of an intra-aquifer confining unit within the upper Floridan aquifer based on well cuttings and geophysical log data. The dual packer set up isolated an interval between 1,266 and 1,286 feet bls. A drawdown test was conducted on February 7, 1994 by pumping this interval for 5 hours at an average rate of 4 gpm. The static water level was measured at 56.52 feet NGVD (density corrected to an equivalent freshwater head of 57.39 feet NGVD). The maximum drawdown was 114.25 feet (corrected for friction loss), and the specific capacity was calculated as 0.04 gpm/ft. Chlorides and TDS concentrations from the zone were 491 and 1,370 mg/L, respectively. The results of the complete anion/cation analyses are reported in **Table 2**. A time-series plot (semi-log) of the recovery data for Packer Test No. 3 is shown in **Appendix C**.

Packer Test No. 4 (1,652 to 1,704 feet bls): The purpose of this packer test was to evaluate the hydraulic and water quality characteristics of the potential FAS monitor interval. The dual packer setup isolated an interval between 1,652 and 1,704 feet bls. A drawdown test was conducted on February 8, 1994 by pumping this interval for 5 hours at an average rate of 35 gpm. The maximum measured drawdown was 58.5 feet (corrected for friction loss), and the specific capacity was calculated as 0.6 gpm/ft. The static water level was measured at 56.51 feet NGVD (density corrected to an equivalent freshwater head of 58.54 feet NGVD, 1929). Chlorides and TDS sampled from the zone were 882 and 2,160 mg/L, respectively. The results of the complete anion/cation analyses are reported in **Table 2**. Time-series plots (semi-log) of the drawdown and recovery data for Packer Test No. 4 are shown in **Appendix C**.

Packer Test No. 5 (1,442 to 1,492 feet bls): This packer test was also used to evaluate the hydraulic and water quality characteristics of the proposed FAS monitor interval. An interval between 1,442 and 1,492 feet bls was tested on February 9, 1994. A drawdown test was conducted by pumping this interval for 2 hours at a rate of 35 gpm. The maximum measured drawdown was 92.5 feet (corrected for friction loss) with the specific capacity calculated as 0.4 gpm/ft. The static water level was measured at 56.52 feet NGVD (density corrected to an equivalent freshwater head of 57.42 feet NGVD). Chlorides and TDS sampled from the zone were 445 and 1,370 mg/L, respectively. The results of the complete anion/cation analyses are reported in **Table 2**. Time-series plots (semi-log) of the drawdown and recovery data for Packer Test No. 5 are shown in **Appendix C**. **Table 2** summarizes the water quality, production capacity, and potentiometric head data obtained from the straddle packer tests conducted within the pilot hole for Well L2-TW.

Table 2. Packer Test Results from L-2 Canal Drill Site, Hendry County, Florida

Identifier	Depth Interval (ft bls)	Specific Capacity gpm/ft/d	Static Head (NGVD, 29)	Sample Date	Cations				Anions					Field Parameters		
					Na ⁺ (mg/L)	K ⁺ (mg/L)	Ca ²⁺ (mg/L)	Mg ²⁺ (mg/L)	Cl ⁻ (mg/L)	Alka as CaCO ₃ (mg/L)	HCO ₃ ⁻ (mg/L)	SO ₄ ²⁻ (mg/L)	TDS (mg/L)	Specific Conductance (umhos/cm)	Temp °C	pH (s.u.)
L2-PW#2	810-1150	6.25	57.21	10/27/99	440	22	100	95	832	85	104	351	1,949	3,382	26.18	7.82
L2-PT#3	1266-1284	0.03	56.52	02/07/94	307	16	73	71	491	91	111	366	1,370	2,240	27.30	7.00
L2-PT#1	1442-1494	0.35	56.52	02/09/94	257	12	78	71	445	90	110	322	1,370	2,230	26.40	7.10
L2-TW	1400-1810	0.60	56.51	01/10/97	366	17	88	89	755	92	112	347	1,900	3,371	27.35	7.51
L2-PT#4	1652-1704	0.60	59.14	02/08/94	535	24	101	104	882	91	112	439	2,160	3,400	25.40	7.10
L2-PT#2	1890-1908	0.43	52.15	02/04/94	1615	46	204	224	3084	96	117	424	5,550	9,990	25.60	7.30
L2-PT#1	2072-2124	15.00	34.91	02/01/94	5910	197	476	678	10734	102	124	1359	19,100	30,800	26.00	7.00

mg/L : milligrams per liter
 umhos/cm: micromhos per centimeter
 °C = degree Celsius
 s.u.: standard unit
 HCO₃⁻: Alkalinity (Alka) as CaCO₃ / 0.8202 (Hem,1986)

TW: Test Well PW: Production Well
 PT: Packer Test -- All tests were conducted in well L2-TW
 ft bls: feet below land surface
 gpm/ft/d: gallon per minute per foot of drawdown
 Elevation Reference (NGVD, 29): National Geodetic Vertical Datum of 1929

Stable Isotope and Carbon-14 Data

Water samples were collected from the two production wells and sent to the University of Waterloo for stable isotope determinations. The analytical services included the determination of the stable isotope compositions for the following parameters: oxygen (¹⁸O), hydrogen (²H) or deuterium (D), carbon (¹³C), and sulfur (³⁴S). Oxygen (¹⁸O) values were determined by carbon dioxide (CO₂) equilibration using standard procedures outlined by Epstein and Mayeda (1953) and Drimmie and Heemskerk (1993). The hydrogen compositions were determined using the methods of Coleman et al. (1982) and Drimmie et al. (1991). Carbon (¹³C) values were performed on carbon dioxide produced from dissolved inorganic carbon (DIC) treated with phosphoric acid using methods

described by Drimmie et al. (1990). An accelerator mass spectrometer (AMS) at the Rafter Radiocarbon Laboratory (Institute of Geological and Nuclear Sciences, New Zealand) was used to determine radiocarbon age (BP), delta carbon-14 (^{14}C), and percent modern carbon (pmc) using procedures outlined in Stuiver and Polach (1977).

The information obtained through the acquisition of isotopic data can complement the inorganic geochemistry and physical hydrogeology investigations. The data collected at this site will be used in a regional investigation (currently being conducted by the author) to better understand the groundwater circulation patterns (Kohout, 1965, 1967), and identify recharge and discharge areas within the FAS. If an interval has a particular isotopic signature, it may help to identify and assist in the mapping of aquifer storage and recovery (ASR) and reverse osmosis (RO) horizons within the upper Floridan aquifer. The ^{14}C dating of groundwater can also be used to determine regional flow velocities estimates within the Floridan aquifer (Hanshaw et al., 1964). The stable isotope and ^{14}C results for the L-2 Canal site are summarized in **Table 3**.

Table 3. Stable Isotope and Carbon-14 from L-2 Canal Drill Site, Hendry County, Florida

Depth (ft bls)	Sample Date	Del- ^{18}O ($^{0}/_{00}$ SMOW)	Del- ^{2}H ($^{0}/_{00}$ SMOW)	Del- ^{37}Cl ($^{0}/_{00}$ SMOC)	Del- ^{13}C ($^{0}/_{00}$ PDB)	Del- ^{34}S ($^{0}/_{00}$ CDT)	Del- ^{14}C ($^{00}/_{00}$)	^{14}C (pmc)	^{14}C Age (Yr B.P.)
L2-PW2									
810-1160	10/27/99	-2.34	-5.17	ND	-2.33	21.70	-978.8	2.05	-31,280
L2-PW1									
1400-1810	01/10/97	-1.56	-8.74	-0.16	-2.89	22.24	-979.7	2.03	-31,250
Definitions					Abbreviations				
ft bls - feet below land surface					PDB - Pee Dee Belemnite				
$^{0}/_{00}$ - per mil					CDT - Canon Diablo Meteorite				
SMOW - Standard Mean Ocean Water					pmc - Percent Modern Carbon				
SMOC - Standard Mean Ocean Chloride					Yr B.P. - Year Before Present				

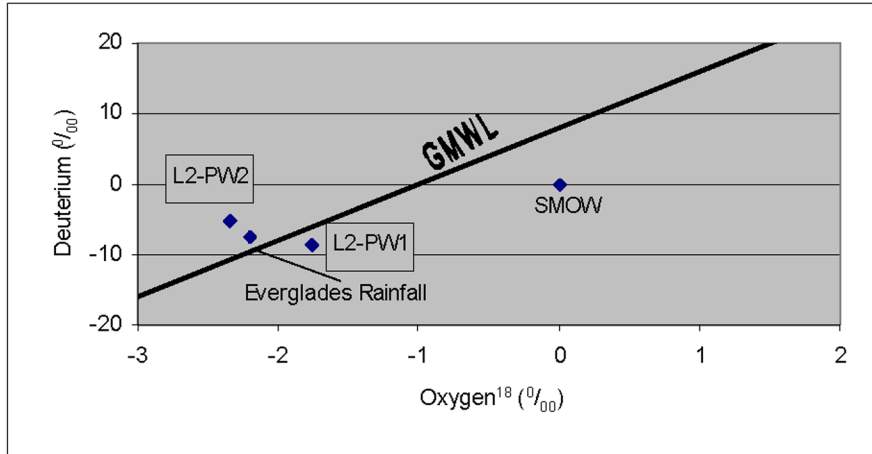

Figure 7. Deuterium versus Oxygen-18 Cross-Plot

The stable isotopic results from the L-2 Canal site indicate that the upper and middle Floridan water are depleted in both ^{18}O and deuterium, as compared to the reference standard (standard mean ocean water [SMOW] were $\delta^{18}\text{O}=0\text{‰}$; $\delta\text{D}=0\text{‰}$). **Figure**

7 shows that the isotopic composition deviates only slightly from the global meteoric water line (GMWL) (Craig, 1961) and mean isotopic composition of recent Everglades rainfall ($\delta^{18}\text{O}=-2.2\text{‰}$; $\delta\text{D}=-7.6\text{‰}$; Meyers et al., 1993). This may indicate that climatic conditions and recharge of meteoric water into the Floridan aquifer were not markedly different.

The ^{14}C activities or percent modern carbon (pmc) values listed in this report are absolute percent modern relative to the National Bureau of Standards (NBS) oxalic acid standard (HOxI) corrected for decay since 1950. The ^{14}C activities of groundwater samples from the upper and middle Floridan are similar with reported values of 2 pmc. The reported radiocarbon ages are also similar in nature with reported ages of approximately 31,000 years before present (BP). The reported radiocarbon ages were not corrected for chemical or isotopic dilution or other factors (e.g., Tamers, 1967; Mook, 1976). If reported radiocarbon ages are considered absolute ages (assuming a closed-system, little or no chemical or isotopic dilution, and no carbon transfer), meteoric recharge to the Floridan would have occurred during the Wisconsin glacial stage (late Pleistocene). During this time (approximately 31,000 years BP), sea level was approximately 200 feet below present sea level (Milliman and Emery, 1968).

Petrophysical and Petrologic Data

During the drilling of the test production well, six rock cores of various lengths were recovered from the Ocala Limestone and Avon Park Formation. Conventional coring methods were implemented with a 4-inch diameter, 10-foot long, diamond-tipped core barrel. Core recoveries ranged for 60 to 90 percent. Six vertically-oriented cores were sent to Core Laboratories in Midland, Texas to determine the following parameters: horizontal and vertical permeability, porosity, grain density, and lithologic character.

Upon arrival at Core Laboratories, a core spectral gamma log was recorded on the cores for downhole correlation. Full diameter and plug samples (when core conditions necessitated) were selected for further core analyses, and fluid removal was achieved by convection oven drying.

Full diameter porosity was determined by direct pore-volume measurement using Boyle's law of helium expansion. Once the samples were cleaned and dried, bulk volume was measured by Archimedes Principle. Grain density was calculated from the dry weight, bulk volume, and pore volume measurements using Equation 1 (American Petroleum Institute, 1998).

$$\text{Grain Density} = \frac{\text{Dry Weight}}{\text{Bulk Volume} - \text{Pore Volume}} \quad [\text{Equation 1}]$$

Porosity was calculated using bulk volume and grain volume measurements using Equation 2.

$$\text{Porosity} = \frac{\text{Bulk Volume} - \text{Grain Volume} \times 100}{\text{Bulk Volume}} \quad [\text{Equation 2}]$$

Steady-state air permeability was measured on full-diameter samples in two horizontal directions, and vertically while the core was confined in a Hassler rubber sleeve at 400 pounds per square inch (psi) net confining stress.

The cores were slabbed and boxed after analysis, and photographed under natural and ultraviolet light. Negatives of the slabbed cores were scanned and stored on a compact disc and reproduced in **Appendix D**. The results of the petrophysical analyses are listed in **Appendix D, Table D-1**. A statistical summary of vertical to horizontal permeability generated over all cored sections of the Floridan aquifer at this site yielded a mean anisotropy value of 0.54 (n=45). The mean horizontal permeability anisotropy (K_{90}/K_{max}) was calculated as 0.92 (n=44). These anisotropy values are useful when performing computer oriented aquifer test analyses of the drawdown and recovery data.

Cross-plots were made of several parameters to determine their corresponding relationships. **Figure 8** depicts a semi-log cross-plot of laboratory determined porosity versus horizontal permeability. The widely scattered data points indicate no linear relationship between horizontal permeability and porosity.

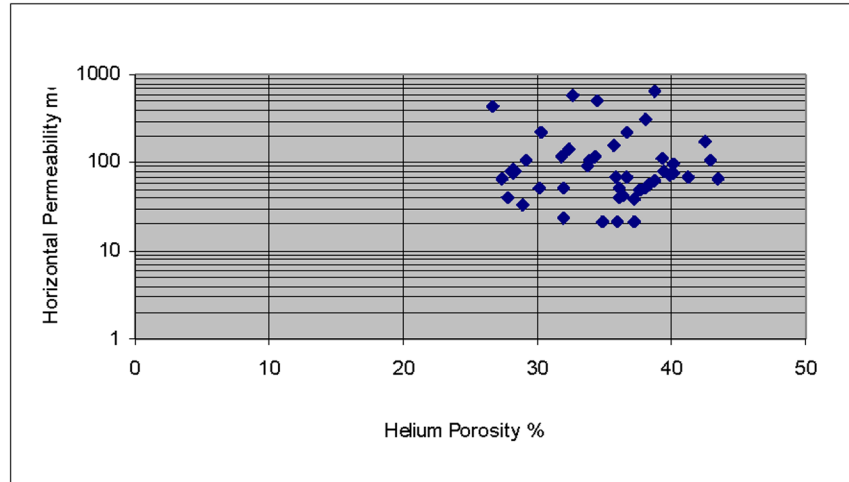

Figure 8. Core Porosity versus Permeability Cross-Plot

A cross-plot of laboratory-determined porosity versus depth is shown in **Figure 9**. These data indicate a minor reduction in porosity with depth. The neutron and density porosity curves derived from the geophysical logs suggest a similar relationship of porosity reduction with depth (Schmoker and Halley, 1982). Laboratory determined porosities are also in close agreement with the neutron and density derived porosity values generated from Geophysical Log Run No. 2 (**Appendix A**).

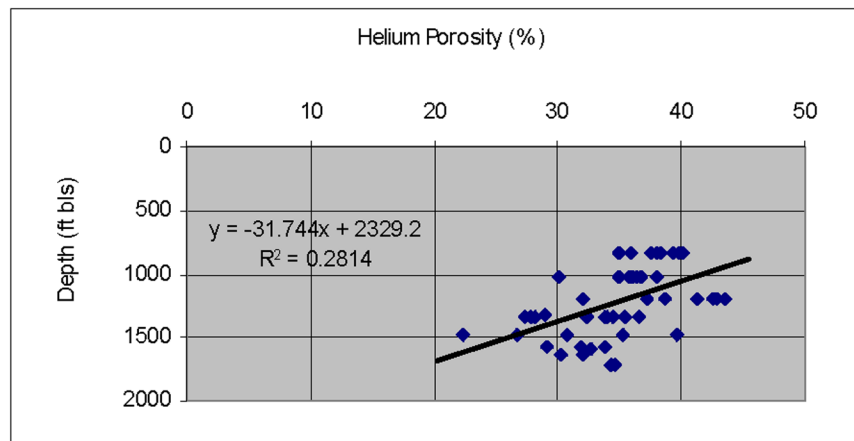

Figure 9. Core Porosity versus Depth

Once the cores were slabbed, they were photographed and analyzed for porosity and permeability by Core Laboratories in Midland, Texas. A petrologic study was conducted on the cores to provide preliminary data on the gross reservoir heterogeneity and depositional environmental (facies) controls on porosity and permeability development within the Floridan aquifer.

The slabbed cores were then examined, and described by Dr. Hughbert Collier of Collier Consulting, Inc. of Stephenville, Texas. Intervals were then selected from which to prepare thin sections. The thin sections were stained with Alizarin Red S to determine dolomite content and examined under a binocular Nikon SMZ-2T and a Nikon

petrographic microscope. Thin section analyses included the identification of porosity types, visual estimation of porosity, rock type, cement type, mineralogy, dominate allochems, fossil type, grain size, sorting, and sand content. Once compiled, this information was used to determine the lithofacies and depositional environment of the various core intervals. A petrologic summary for each core section, generated by Collier Consulting, is provided in **Appendix E, Table E-1**. Individual photomicrographs of selected cores are reproduced in **Appendix E**. The petrologic analysis combined with the petrophysical data indicates variations in horizontal permeability and porosity based on lithofacies and corresponding depositional environment. The highest mean horizontal permeability (228.38 millidarcies) corresponds to a cored section at approximately 1,580 feet bls, consisting of foraminiferal-peloidal packstone, assumed to be deposited in a restricted lagoonal shoal environment.

Aquifer Performance Testing

An aquifer performance test (APT) was conducted to determine the in situ hydraulic parameters for a section (1,400 to 1,810 feet bls) of the Floridan aquifer at the L-2 Canal site. The principle factors of aquifer performance, such as transmissivity and storage coefficients, can be calculated from the drawdown and/or recovery data obtained from a proximal monitor well completed in the same interval. If the aquifer tested is semi-confined, the hydraulic parameter of leakance of the semi-permeable layer(s) can also be determined.

A 73.25-hour constant-rate discharge (245 gpm) test was conducted on an interval from 1,400 to 1,810 feet bls. **Figure 10** shows the well configuration of the monitor well (L2-TW) and test production well (L2-PW1) used in the APT. The 73.25-hour drawdown phase was followed by a 72-hour recovery period, where water levels were allowed to return to background condition.

An 8-inch diameter submersible pump was installed in the test production well on January 6, 1997, with the pumping bowl set at 270 feet bls. This depth was chosen based on preliminary data indicating significant drawdowns would occur. The wellhead was re-installed with appurtenances consisting of a shutoff valve, discharge pressure gauge, and wellhead pressure gauge. A 6-inch diameter PVC discharge line was connected to the wellhead. A 6-inch diameter, circular orifice weir with a 3-inch diameter orifice plate was used to measure discharge rates during pumping, verified by an in-line flowmeter. A pressure transducer was installed on the orifice weir to record discharge rates during the pump test at 5-minute intervals. Additional pressure transducers were installed on/in both the production and monitor wells and connected to a Hermit 2000 (Insitu, Inc) data logger with electronic cables. The transducers and data logger were used to measure and record water-level changes at predetermined intervals during testing operations.

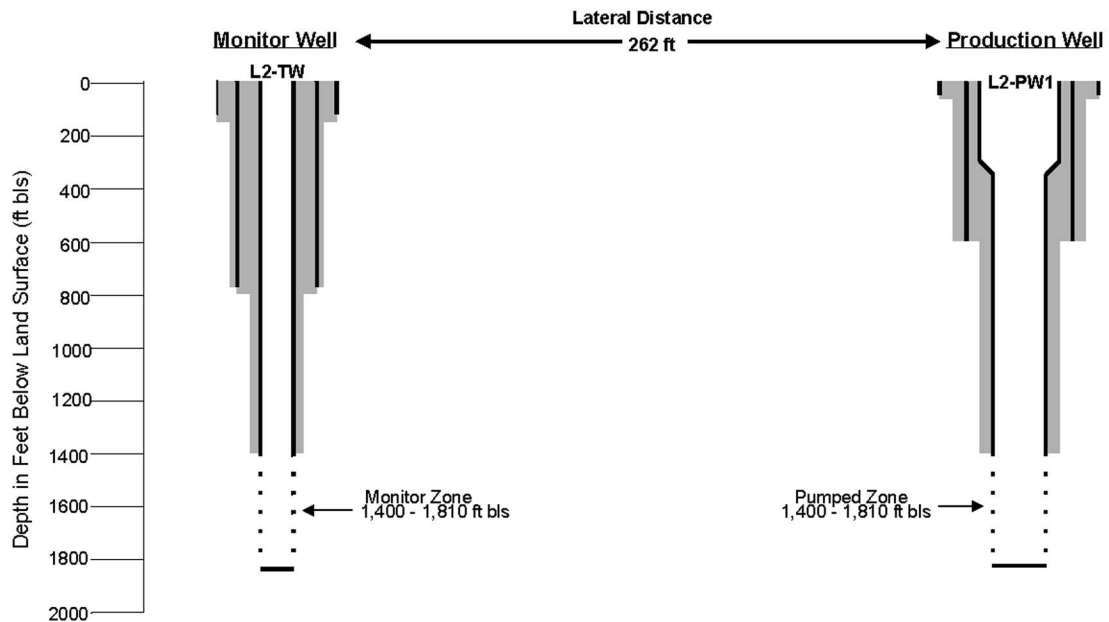

Figure 10. Aquifer Performance Test -- Well Configuration

On January 7, 1997, a specific-capacity test was conducted to determine the most efficient pump rate for the 72-hour drawdown test. Once completed, water levels were allowed to recovery to static condition. During the morning of January 8, 1997, the drawdown phase of the APT started by initiating pumping of the test production well (L2-PW1) at 245 gpm. During the drawdown phase, water levels and pump rates were continuously measured and recorded by the installed electronic instruments. Pumping continued uninterrupted for the next 73.25 hours, completing the drawdown phase on January 11, 1997. Semi-log plots of the drawdown data for both the test production well (L2-PW1) and monitor well (L2-TW) are shown in **Figures 11 and 12**.

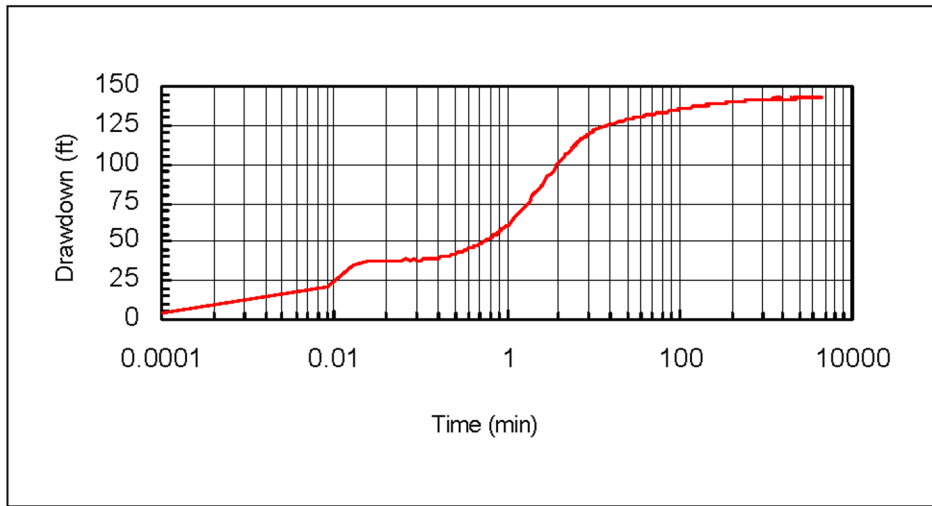

Figure 11. Time Series Plot of Drawdown Data -- Production Well No. 1 (L2-PW1)

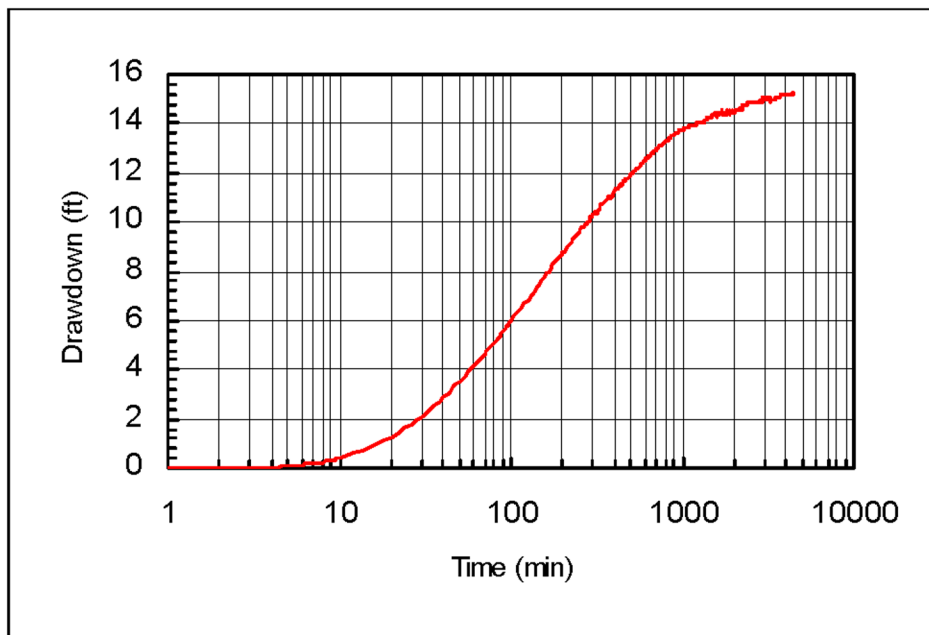

Figure 12. Time Series Plot of Drawdown Data --Monitor Well (L2-TW)

The discharge data from the 6-inch diameter, circular orifice weir acquired during the pumping phase of the APT are shown in **Figure 13**. Minor fluctuations (less than $\pm 1\%$) in pump rates during the course of the APT, shown in **Figure 13**, were not substantial enough to affect the overall test results.

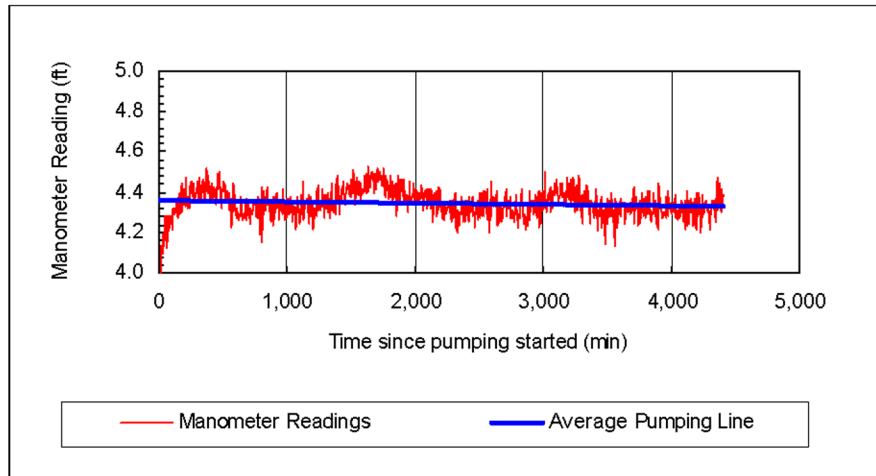

Figure 13. Time Series Plot of Pumping Rates during Aquifer Performance Test

Before pumping stopped, the data loggers were reconfigured to record the recovery data. The pump was manually stopped, and water levels were allowed to recovery to static condition. The recovery phase of the APT continued for 72 hours, ending on January 14, 1997. The recovery data for both the test production well (L2-PW1) and monitor well (L2-TW) are shown in **Figures 14** and **15**. Electronic copies of the original drawdown, recovery, and manometer data are archived and available for review at the District's headquarters in West Palm Beach, Florida.

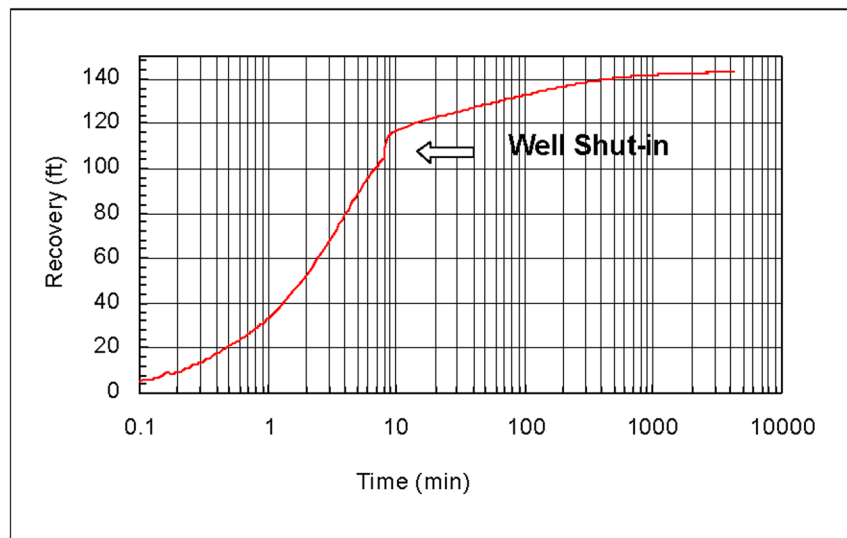

Figure 14. Time Series Plot of Recovery Data -- Production Well No. 1 (L2-PW1)

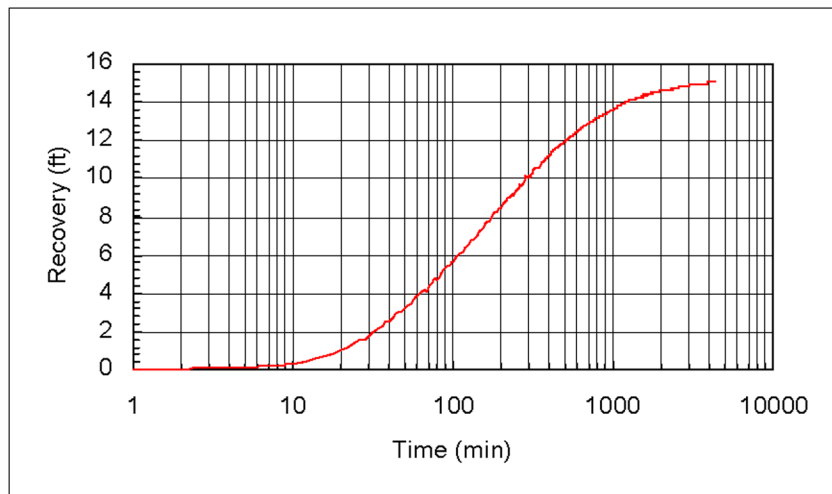

Figure 15. Time Series Plot of Recovery Data -- Monitor Well (L2-TW)

A log-log plot of drawdown versus time is shown in **Figure 16**. The shape of the drawdown curve is indicative of a leaky-type aquifer where the late-time drawdown remains relatively flat. A leaky (semi-confined) aquifer is defined as an aquifer that loses or gains water (depending on the pressure gradients) through an adjacent semi-confining unit (aquitard). If a semi-confining unit(s) is present, it may provide water to the pumping well. The overlying and underlying sediments at this site are composed of highly porous (25 to 45 percent) mudstones to wackestones, which have the potential to supply additional water to the pumping well. However, proximal FAS monitor wells completed either above or below the test interval (1,400 to 1,810 feet bls) were not available for monitoring during the APT to discern the direction or quantify the relative contribution of the semi-confining units.

Based on the lithologic character of the overlying and underlying units, and the resulting drawdown curve derived from the pump test, the Moench analytical model was used to analyze the data. Moench (1985) derived an analytical solution for predicting water-level displacements in response to pumping in a leaky confined aquifer assuming storage in the aquitard(s) and wellbore skin. Other assumptions related to this solution are provided in Moench (1985). The production interval in the middle Floridan aquifer from 1,400 to 1,810 feet bls yielded a transmissivity value of 10,150 gallons/day/foot, a storage coefficient of 1.2×10^{-4} , (r/B) value of 0.06, with a calculated leakance of $5.3 \times 10^4 \text{ gpd/H}^3$ ft.

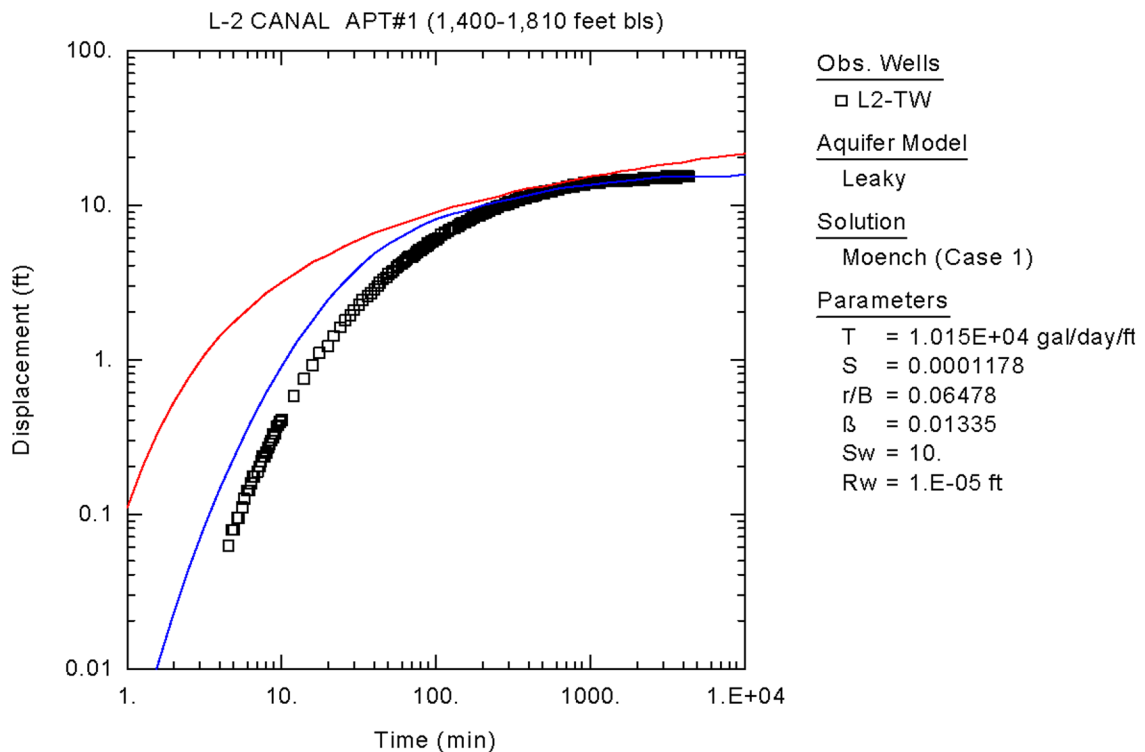

Figure 16. Log-Log Plot of Drawdown versus Time -- Monitor Well (L2-TW)

Long-Term Ground Water Level Monitoring Program

Shortly after the construction of the 4-inch diameter, Floridan aquifer monitor well (L2-TW), a monthly potentiometric-head monitoring program was established. Pressures were recorded from the 4-inch diameter monitor well using a 50-psi transducer and a Hermit 3000 (Insitu, Inc.) data logger once a month. An automated pressure recorder (Insitu Troll 4000) was installed in the FAS monitor well (L2-TW) on September 22, 1999. The sample frequency was set to hourly readings to identify short- and long-term stresses to the middle Floridan aquifer.

All pressures readings are converted to equivalent heads (in feet) using a conversion factor of 2.31 feet of head per psi. Once the pressures are converted, they are added to the surveyed measuring point elevation to obtain a potentiometric head referenced to the NGVD of 1929.

The long-term hourly potentiometric head data and barometric pressure are shown in hydrographs (**Figure 17**). Average Floridan aquifer potentiometric head at this location is 57.9 feet NGVD with variations of ± 2.0 feet. The hydrographs generated using hourly readings show diurnal variations due to tidal loading and seasonal changes due to barometric pressure variations.

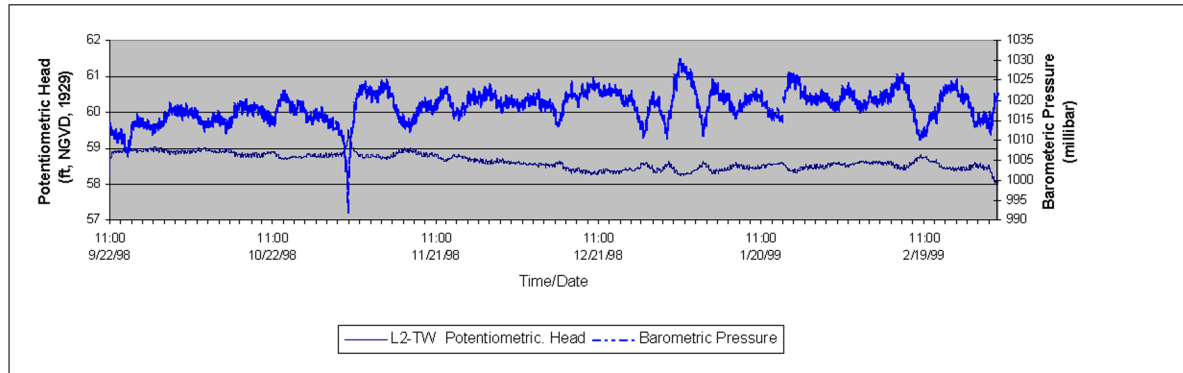

Figure 17. Long-Term Hydrograph -- Monitor Well (L2-TW)

HYDROGEOLOGY

Three major aquifer systems underlie this site: the Surficial Aquifer System (SAS), the Intermediate Aquifer System (IAS), and the Floridan Aquifer System (FAS). The latter is the focus of this test well program. These aquifer systems are composed of multiple, discrete aquifers separated by low permeable confining units that occur throughout this Tertiary/Quaternary aged sequence. **Figure 18** shows a hydrogeologic section underlying the L-2 Canal site.

Surficial Aquifer System

The SAS extends from land surface (top of the water table) to a depth of 180 feet bls. It consists of Holocene and Pliocene-Pleistocene aged sediments. The undifferentiated Holocene sediments occur from land surface to a depth of 18 feet bls, and consist of unconsolidated orange to light gray, very fine to coarse grained quartz sands and shell fragments within a calcilutite matrix. The sediments from 18 to 120 feet in depth are composed primarily of light gray, poorly consolidated, moderately sorted, very fine to very coarse grained quartz sands and shells. The Pliocene aged Tamiami Formation forms the bulk of the productive capacity of this system that ranges from a moderate to well indurated biogenic limestone to moderately indurated calcareous sandstone. Low permeable arenaceous calcilutite at 180 feet bls forms the base of the surficial aquifer at this site. The natural gamma ray log from 180 to 195 feet bls suggests a minor clay and phosphate component with emissions above 30 American Petroleum Institute (API) units.

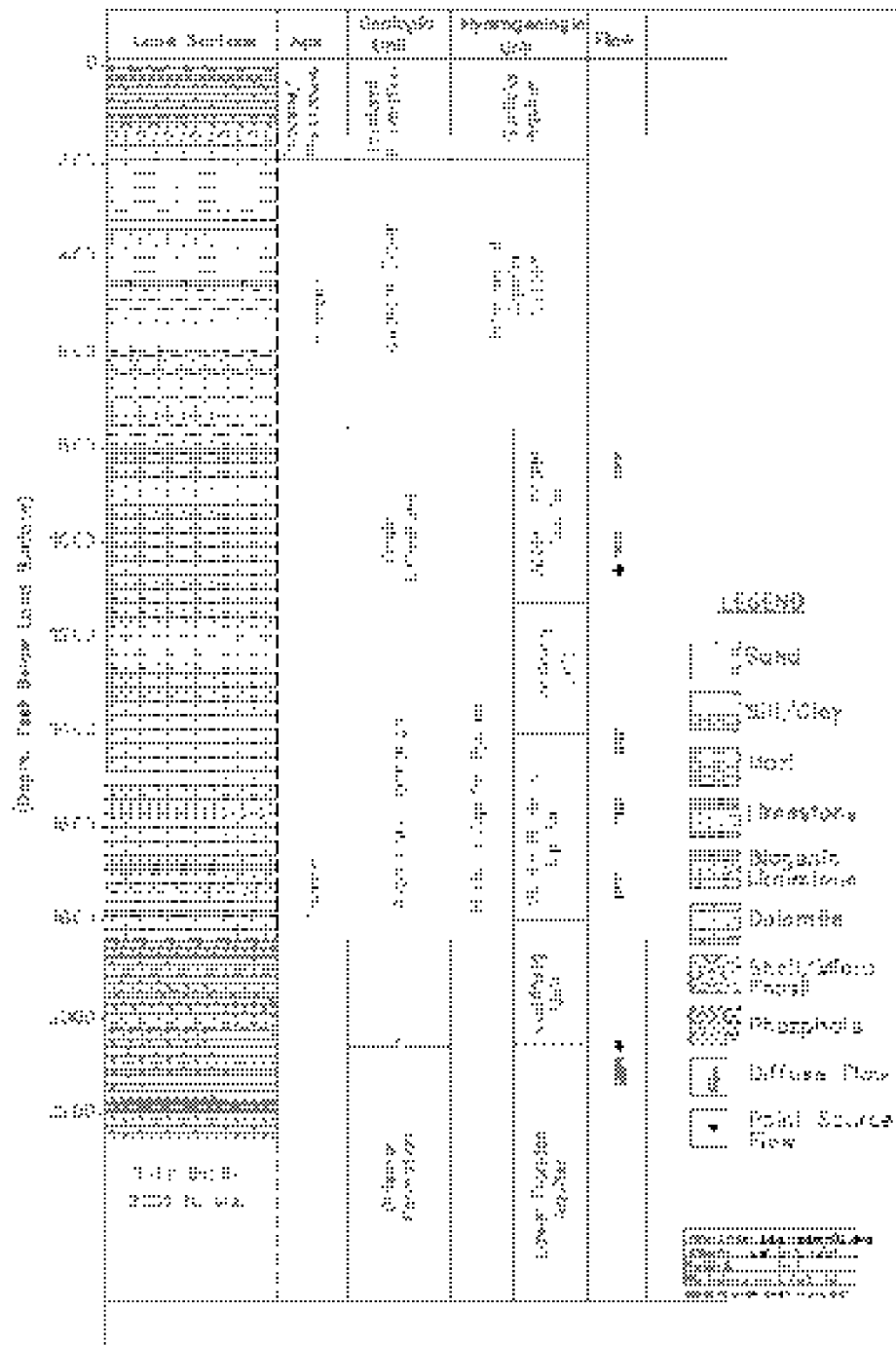

Figure 18. Hydrogeologic Section Underlying L-2 Canal Site

Intermediate Aquifer System

Below the SAS lies the IAS, which extends from 180 to 780 feet bls. The Peace River and Arcadia Formations of the Miocene-Pliocene aged Hawthorn Group (Scott, 1988) act as semi-confining units, separating the FAS from the SAS. The low permeable siliciclastic sediments of the Peace River Formation form the top of this system, which extends from 195 to 435 feet bls. The signature of the compensated sonic log through this section indicates a soft, nonindurated, high porosity clayey, silt-sand unit with average travel times of approximately 130 microseconds per foot ($\mu\text{sec}/\text{ft}$) (L2-TW, Geophysical Log Run No.1). Compressional wave (P-wave) travel times of approximately $\sim 130 \mu\text{sec}/\text{ft}$ are typical of porous silt and sand units, which correspond to the grayish-green clayey silts and calcareous silty sand units underlying this site.

A change in lithology from predominately siliciclastics to carbonate-rich sediments occurs below 435 feet bls, as identified from well cuttings. This change in lithology below 435 feet bls, also corresponds to a decrease in sonic travel times and corresponding increase in bulk densities (sonic and density log traces from L2-TW, Geophysical Log Run No. 1, **Appendix A**). A low to moderately permeable, light gray to tan, poorly to moderately indurated limestone (wackestone) occurs from 435 to 475 feet bls. Based on its hydraulic character (moderate permeability based on well cuttings) and stratigraphic position, the term *mid-Hawthorn aquifer* (Wedderburn et al., 1982) was assigned to this limestone unit. Unconsolidated calcareous muds, silts, marls, and poorly indurated mudstones extend from 475 to 720 feet in depth. Thin, intermittent, high porosity, poorly indurated carbonate units present within this interval produce an irregular, spiked sonic trace with average sonic travel times of approximately $120 \mu\text{sec}/\text{ft}$. The natural gamma log below 435 feet bls also produces thin, intermittent, high gamma radiation peaks, but these are associated primarily with intervals of high phosphatic sand/silt content. These low permeable units form the lower boundary of the IAS.

The basal Hawthorn unit (Reese, 2000; Reese and Memberg, 2000) occurs from 720 to 780 feet bls, and is composed primarily of light to medium gray, poorly to moderately indurated phosphatic mudstones. This phosphatic mudstone unit produces a distinct natural gamma signature (natural gamma log trace from L2-TW, Geophysical Log Run No. 1, **Appendix A**) and can be identified over a regional extent (Reese and Memberg, 2000). If productive, this unit may represent the uppermost portion of the Floridan aquifer. At this site, the basal Hawthorn unit, which is composed of low permeable carbonate sediments, acts as part of the intermediate confining unit.

Floridan Aquifer System

The FAS consists of a series of Tertiary age limestones and dolostones. The system includes permeable sediments of the lower Arcadia Formation, Suwannee Limestone, Ocala Limestone, Avon Park Formation, and the Oldsmar Formation. The Paleocene age Cedar Keys Formation with evaporitic gypsum and anhydrite forms the lower boundary of the FAS (Miller, 1986).

Upper Floridan Aquifer

The top of the FAS, as defined by the Southeastern Geological Society Adhoc Committee on Florida Hydrostratigraphic Unit Definition (1988), coincides with the top of a vertically continuous permeable carbonate sequence. The Upper Floridan aquifer consists of thin, high permeable water bearing horizons interspersed within thick, low permeable units of Oligocene to middle-Eocene age sediments, including the Suwannee Limestone (if present), Ocala Limestone, and Avon Park Formation. At this site, the top of the FAS occurs at a depth of 780 feet bls, which coincides with the top of the Ocala Limestone. The Suwannee Limestone (*unnamed Limestone*) of Oligocene age was not identified in the subsurface at this site.

Based on examination of well cuttings by the FGS, the Ocala Limestone occurs from 780 to 1,285 feet bls. The Ocala Limestone is characterized by light orange to beige, poorly to moderately indurated mudstones and packstones. These limestones exhibit a broad range of textural fabrics ranging from calcareous muds to foraminiferal grainstones. The allochems consists primarily of larger foraminifer tests, such as *Lepidocyclina* sp., *Nummulites* sp., *Operculioides* sp., and irregular echinoids (Applin and Applin, 1944).

The upper boundary of the Ocala Limestone is marked by a change in lithology from a medium to dark gray poorly indurated mudstone of the Arcadia Formation to a white to tan, poorly indurated, phosphate-free, chalky, foraminiferal limestone. A significant attenuation of the natural gamma response (geophysical log traces from Geophysical Log Run No. 2, **Appendix B**) and the first occurrence of *Lepidocyclina* sp., a diagnostic microfossil of the Ocala Limestone, helped to identify the top of this lithostratigraphic unit.

The individual geophysical log responses also indicate small lithologic and hydraulic variations within the Ocala Limestone. The sonic log through the Ocala indicates only slight variations in travel times, ranging between 110 to 125 $\mu\text{s}/\text{ft}$. The derived neutron-density porosities based on a limestone matrix (density of $2.71 \text{ gm}/\text{cm}^3$) range from 30 to 38 porosity units (p.u.). These two porosity curves generally overlay one another, which is indicative of a relatively clean limestone unit (Hallenberg, 1998 [refer to geophysical log traces from L2-TW Run No. 2, **Appendix B**]).

Generally, two predominant permeable zones generally exist within the upper FAS. The uppermost permeable zone typically lies between 800 and 1,300 feet bls. The most transmissive part of this upper zone usually occurs near the top, coincident with a regional unconformity at the top of Eocene-aged formations (approximately 780 feet bls). Well cuttings and production type geophysical logs suggest that neither of these productive horizons exist within the upper Floridan aquifer at this site, resulting in limited productive capacities. A slight deflection in the temperature differential log trace at 1,110 feet bls suggests the presence of a minor flow zone. However, a specific capacity test on an interval from 810 to 1,155 feet bls yielded only 6.25 gallons per minute per foot (gpm/ft) of drawdown when pumped at a rate of 300 gpm. In addition, whole-diameter rock cores taken from the upper Ocala Limestone between 830 to 1,030 feet bls yielded an average laboratory determined horizontal permeability of 87.5 millidarcies. This value is relatively

low, as compared to productive intervals in the FAS that have values on the order of several hundred millidarcies to several darcies.

The lithologic character of the upper portion of the Avon Park is very similar to the light orange to beige chalky limestones of the lower Ocala Limestone, as indicated in the well cuttings and geophysical log responses. The top of Avon Park Formation was identified by the FGS at a depth of 1,285 feet bls, with the first occurrence of the diagnostic microfossil *Lithionelli Floridanna* (primarily a biostratigraphic designation [Applin and Applin, 1944]). The lack of lithologic differences between the two stratigraphic units may indicate similar depositional environments. The lower Ocala Limestone and upper Avon Park Formation from 1,155 to 1,400 feet bls form an interaquifer confining unit within the FAS at this site. This interval consists of low permeable mudstones and wackestones. A packer test in the lower Ocala Limestone (1,266 to 1,286 feet bls) yielded a specific capacity of only 0.03 gpm/ft. Formation samples from this interval do not show evidence of large-scale secondary porosity development (e.g., good pinhole or moldic porosity). In addition, the production type geophysical logs traces (e.g., temperature and flowmeter logs) indicate no productive horizons, which supports the confining nature of this interval.

Middle Floridan Aquifer

Permeable intervals have been documented within the Avon Park Formation, ranging in depth from 1,400 to 1,600 feet bls (Miller, 1986). At this site, moderate to well indurated packstones to grainstone, interbedded with minor dolostone units occurs from 1,400 to 1,810 feet bls. These limestone units show evidence of varying degrees of pinhole and moldic porosity development with the dolostones being slightly surcrosic in nature. However, a well-defined flow zone(s) is not evident, as indicated by smooth log traces in both the temperature and flowmeter logs (log traces from L2-TW Geophysical Log Run No. 2, **Appendix A**). The lithology and moderate degree of secondary porosity development (as indicated in the well cuttings) suggests low to moderate production capacity over this interval (1,400 to 1,810 feet bls). From a groundwater resource perspective, this interval represents the most productive interval above the USDW, based on preliminary hydraulic, lithologic, and water quality data. Therefore, this interval was identified for composite aquifer testing and long-term water level and water quality monitoring.

Miller (1986) observed that portions of the lower Avon Park Formation are fine-grained and have low permeability, thereby acting as interaquifer confining units within the FAS. Moderately indurated, low permeable packstones with intermittent dolostone units occur in the subsurface from 1,810 to 2,057 feet bls. At 2,042 feet bls, a 15-foot interval of well indurated, cryptocrystalline (euhedral to subhedral) dolostone forms an effective lower confining unit. A significant change in permeability and water quality occurs at a depth of 2,058 feet.

Lower Floridan Aquifer

Below the confining unit identified between 1,810 and 2,057 feet bls, thin, moderate to highly permeable, fractured, and cavernous dolostones occur interspersed within low permeable dolostone and limestone units. From 2,070 to 2,130 feet bls, the caliper log indicates an enlarged borehole with diameters in excess of 30 inches. The majority of the natural artesian flow is produced from this interval during reverse air drilling with a significant increase in natural flow from the borehole. A flowmeter log could not be used to quantify flow generated by this horizon because the impeller-type tool could not navigate through the cavernous zone. When this interval was back-plugged, natural flow rates decreased significantly from 800 to approximately 200 gpm. Based on Meyers (1989) and Reese (2000), the interval from 2,057 to 2,200 feet in depth was identified as the uppermost dolostone unit of the lower Floridan aquifer. Based on the objectives of this drilling program, the pilot hole only extends slightly past the upper dolostone unit of the lower Floridan to a total depth 2,235 feet bls.

SUMMARY

The top of the Floridan aquifer occurs at a depth of 780 feet bls with the first occurrence of the contiguous semi-permeable limestone units of the Ocala Limestone.

- Based on formation samples and geophysical logs, the Suwannee Limestone of Oligocene age was not identified in the subsurface at this site.
- Lithologic and geophysical logs, specific capacity tests, packer test results, and petrophysical data indicate limited production capacity of the upper Floridan aquifer. The results of a step-drawdown test on the upper Floridan aquifer (810 to 1,160 feet bls) yielded 6.25 gpm per foot of drawdown at a pump rate of 300 gpm. Horizontal permeability results from full-diameter core tests ranged from 7.15 to 593 millidarcies.
- The production interval in the middle Floridan aquifer from 1,400 to 1,810 feet bls yielded a transmissivity value of 10,150 gpd/ft, a storage coefficient of 1.2×10^{-4} , and a (r/B) value of 0.06 with a calculated leakance of 5.3×10^{-4} gpd/ft³.
- Water quality data indicate that chloride and TDS concentrations in the upper Floridan aquifer waters (800 to 1,160 feet bls) exceeded potable drinking water standards and ranged from 450 to 1,000 and 1,300 to 2,400 mg/L, respectively.
- The base of the USDW, those waters having TDS concentrations less than 10,000 mg/L, occurs at a depth of approximately 2,050 feet bls, based on geophysical log and packer test data.
- Reverse-air discharge rates and fluid-type (flowmeter and temperature) geophysical logs show that the majority of natural

flow occurs below the base of the USDW, at a depth of 2,070 feet. This flow coincides with the fractured and cavernous dolostones identified as the upper dolostone unit of the lower Floridan aquifer.

- The highest laboratory determined horizontal permeability (228.38 millidarcies) corresponds to a cored section at approximately 1,580 feet bls, consisting of foraminiferal-peloidal packstone, assumed to be deposited in a restricted lagoonal shoal environment.
- A statistical summary of vertical to horizontal permeability ratios generated over all cored sections of the Floridan aquifer at this site yielded a mean anisotropy value of 0.54. The mean horizontal permeability anisotropy (K_{90}/K_{max}) was calculated as 0.92 (n= 44).
- The average potentiometric head for the Floridan monitoring interval (1,400 to 1,810 feet bls) is 57.9 feet (NGVD) with maximum variations of ± 2 feet. Water levels in the Floridan aquifer respond to external stresses such as tidal loading and barometric pressure variations.

REFERENCES

- American Petroleum Institute. 1998. *Recommended Practices for Core Analysis*.
- Applin, P.L. and E.R. Applin. 1944. Regional subsurface stratigraphy and structure of Florida and Southern Georgia. *AAPG Bulletin*, 28(12):1673-1753.
- Coleman, M.L., T.J. Shepherd, J.J. Durham, J.E. Rouse, and G.R. Moore. 1982. Reduction of Water with Zinc for Hydrogen Isotope Analysis. *Analytical Chemistry*, 54:993-995.
- Craig, H. 1961. Isotopic Variations in Meteoric Waters. *Science*, 133:1702-1703.
- Drimmie, R.J., A.R. Heemskerk, W.A. Mark, and R.M. Weber. 1991. Deuterium by Zinc Reduction, Technical Procedure 4.0, Rev. 02. Environmental Isotope Laboratory: 6 pages. Department of Earth Sciences, University of Waterloo, Ontario, Canada.
- Drimmie, R.J. and A.R. Heemskerk. 1993. Water 18O by CO₂ Equilibration, Technical Procedure 13.0, Rev.02. Environmental Isotope Laboratory: 11 pages. Department of Earth Sciences, University of Waterloo, Ontario, Canada.
- Dunham, R.J. 1962. Classification of Carbonate Rocks according to depositional texture. *Classification of Carbonate Rocks* (W.E. Ham, ed.), Mem. AAPG, 1:108-121.
- Epstein, S. and T.K. Maeda. 1953. Variations of the 18O/16O ratio in natural waters. *Geochimica et Cosmochimica Acta*, 4:213.
- Fetter, C.W. 1988. *Applied Hydrogeology*. Columbus, OH: Merrill Publishing Company.
- Hallenburg, J.K. 1998. *Standard Methods of Geophysical Formation Evaluation*. Boca Raton, FL: CRC Press, Lewis Publishing.
- Hanshaw, B.N., W. Back, and M. Rubin. 1964. Radiocarbon determinations for estimating flow velocities in Florida. *Science*, 143:494-495.
- Hem, J.D. 1986. *Study and Interpretation of the Chemical Characteristics of Natural Water*, 3rd ed. Water Supply Paper 2254:262, United States Geological Survey, Tallahassee, FL.
- Kohout, F.A. 1967. Ground-water flow and the geothermal regime of the Florida Plateau, *Trans. Gulf Coast Assoc. Geol. Soc.*, 17:339-354.
- Meyer, F.W. 1989. *Hydrogeology, Ground-Water Movement, and Subsurface Storage in the Floridan Aquifer System in Southern Florida*. Professional Paper 1403-G, United States Geological Survey, Tallahassee, FL.
- Meyers, J.B., P.K. Swart, J.L. Myers. 1993. Geochemical evidence for groundwater behavior in an unconfined aquifer, South Florida. *Journal of Hydrology*, 149:249-272.
- Miller, J.A. 1986. *Hydrogeologic Framework of the Floridan Aquifer System in Florida and in Parts of Georgia, Alabama, and South Carolina*. Professional Paper 1403-B, United States Geological Survey, Tallahassee, FL.
- Milliman, J.D. and K.O. Emery. 1968. Sea levels during the past 35,000 years, *Science*, 162:1121-1123.

- Moench, A.F. 1985. Transient flow to a large-diameter well in an aquifer with storative semi-confining layers, *Water Resources Research*, 21(8): 1121-1131.
- Mook, W.G. 1976. The dissolution-exchange model for dating groundwater with ^{14}C . In *Interpretation of Environmental Isotope and Hydrochemical Data in Groundwater Hydrology*, IAEA, 213-225. Vienna.
- Reese, R.S. 2000. *Hydrogeology and the Distribution of Salinity in the Floridan Aquifer System, Southwestern Florida*. Water Resources Investigation Report 98-4253, 86p., 10pls. United States Geological Survey, Tallahassee, FL.
- Reese, R.S. and Memberg, S.J. 2000. *Hydrogeology and the Distribution of Salinity in the Floridan Aquifer System, Palm Beach County, Florida*. Water Resources Investigation Report 99-4061. United States Geological Survey, Tallahassee, FL.
- Schmoker, J.W. and R.D. Halley. 1982. Carbonate Porosity versus Depth, a predictable relation for South Florida. *AAPG Bulletin*, 66:2561-2570.
- Scott, T.M. 1988. The Lithostratigraphy of the Hawthorn Group (Miocene) of Florida. *Florida Geological Survey Bulletin*, 59.
- Southeastern Geological Society Ad Hoc Committee on Florida Hydrostratigraphic Unit Definition. 1986. *Hydrogeologic Unit of Florida: Florida Department of Natural Resources, Bureau of Geology, Special Publication 28:9*.
- South Florida Water Management District. 1994. *Comprehensive Quality Assurance Plan*, South Florida Water Management District, West Palm Beach, FL.
- Stuiver, M. and H.A. Polach. 1977. Discussion, Reporting of ^{14}C Data. *Radiocarbon*, 19(3):355-363.
- Tamers, M.A. 1967. Surface-water infiltration and groundwater movement in arid areas of Venezuela, *Isotopes in Hydrology*, IAEA. pp. 339-351. Vienna.
- Wedderburn, L.A., M.S. Knapp, D.P. Walz, and W.S. Burns. 1982. *Hydrogeologic Reconnaissance of Lee County, Florida*. Technical Publication 82-1, South Florida Water Management District, West Palm Beach, FL.

APPENDIX A

GEOPHYSICAL LOGS

Geophysical logs of Wells L2-TW, L2-PW1, and LW-PW2 are shown in **Figures A-1 through A-5**.

This page is intentionally left blank.

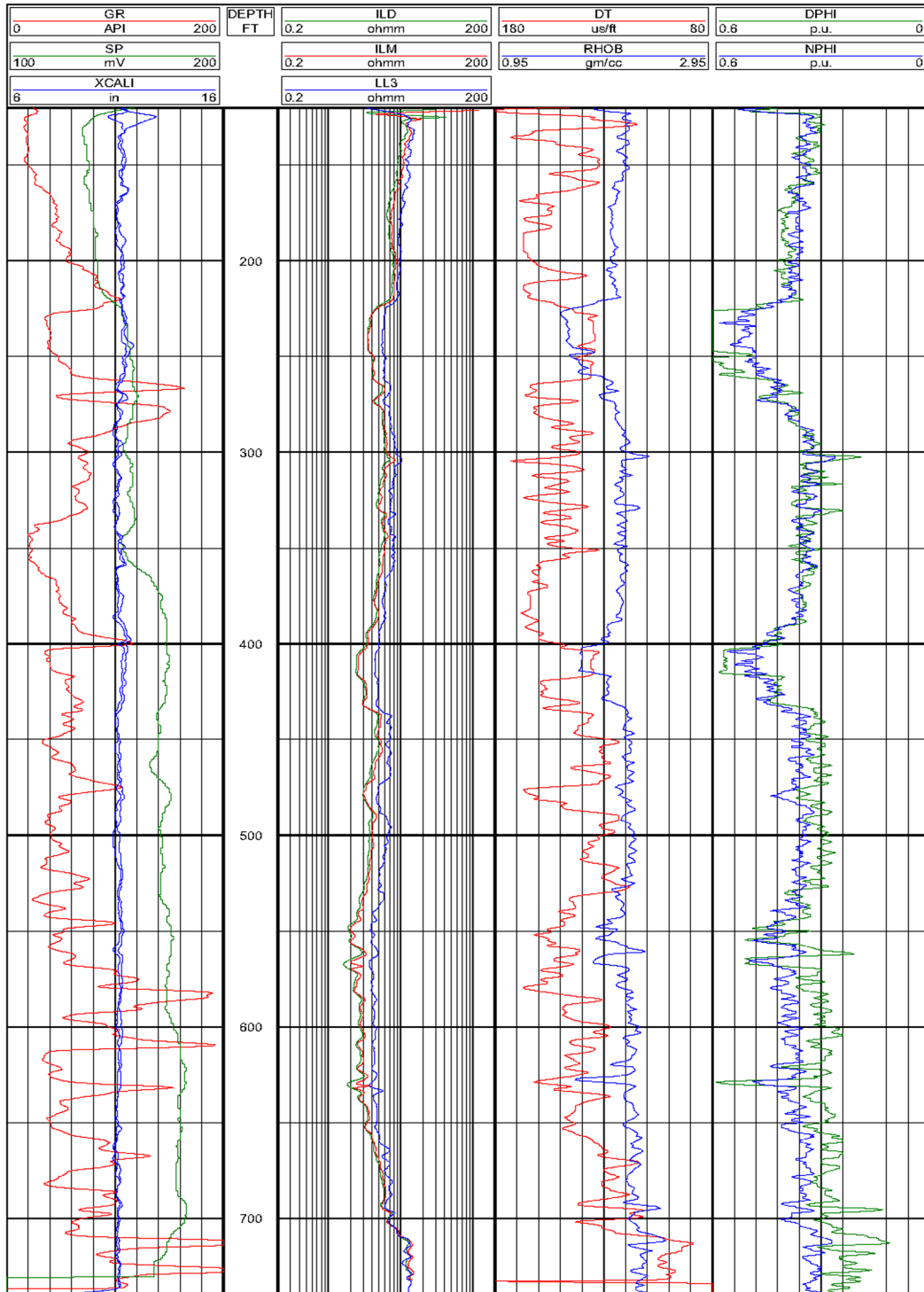

Figure A-1. Geophysical Log Run No. 1 (L2-TW)

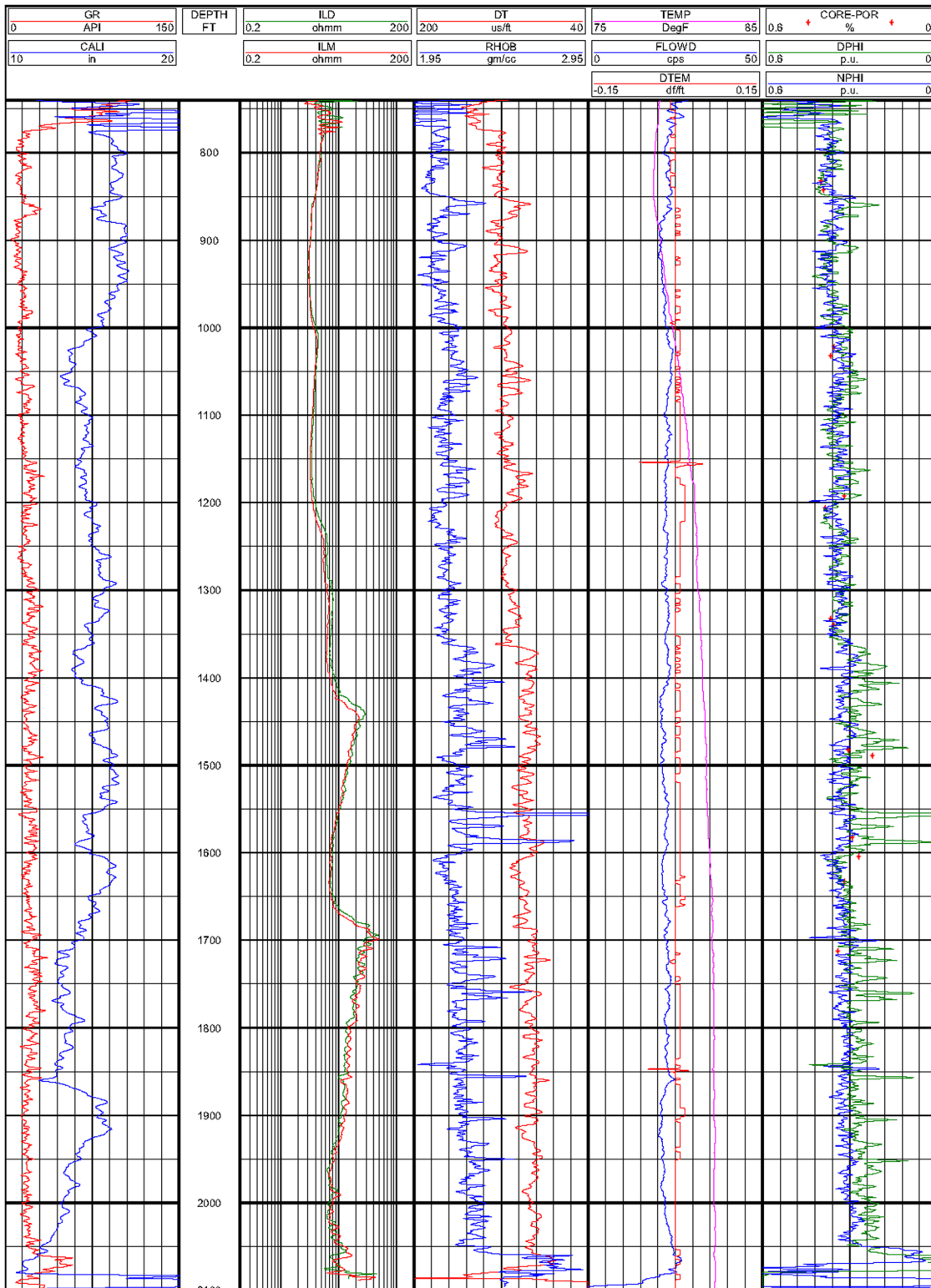

Figure A-2. Geophysical Log Run No. 2 (L2-TW)

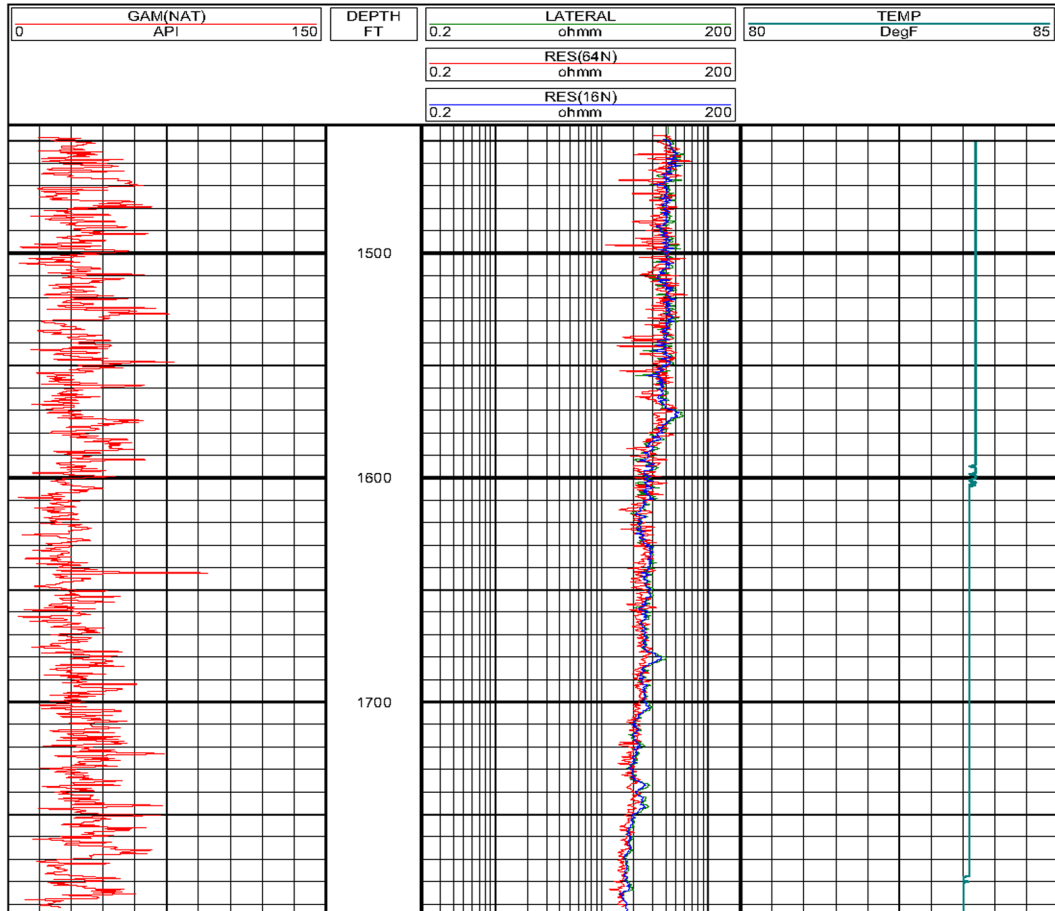

Figure A-3. Geophysical Log Run No. 1 (L2-PW1)

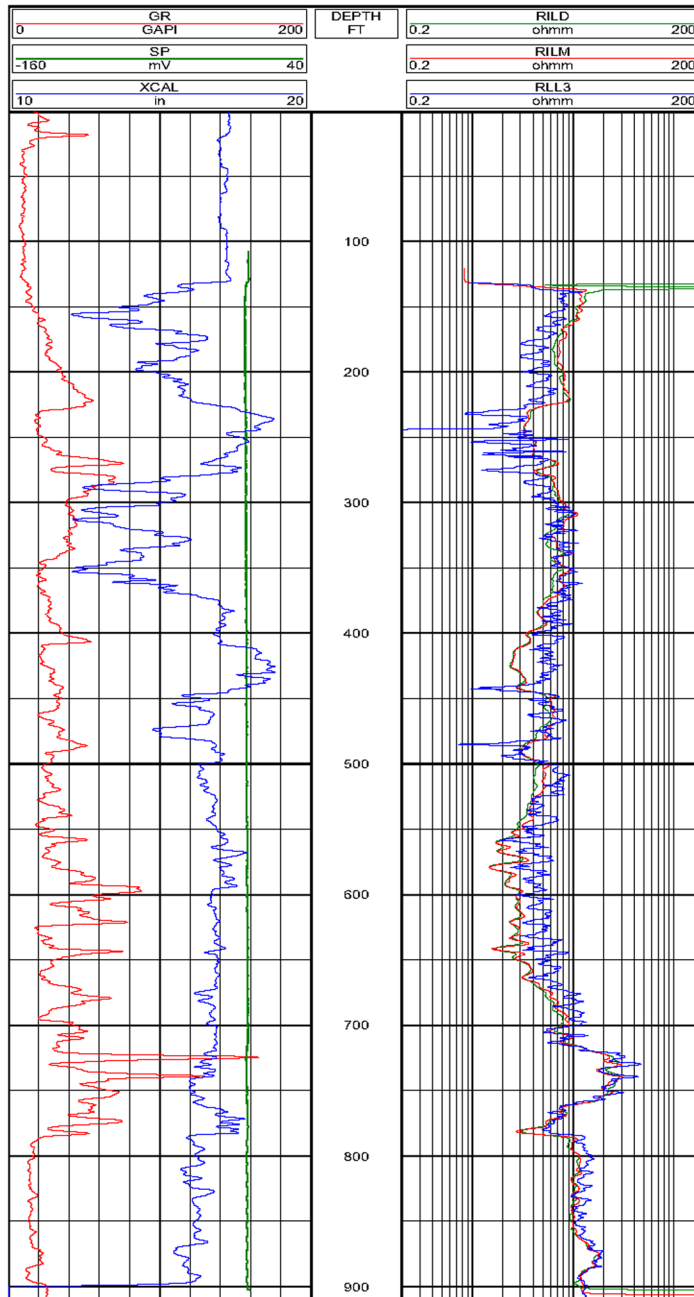

Figure A-4. Geophysical Log Run No. 1 (L2-PW2)

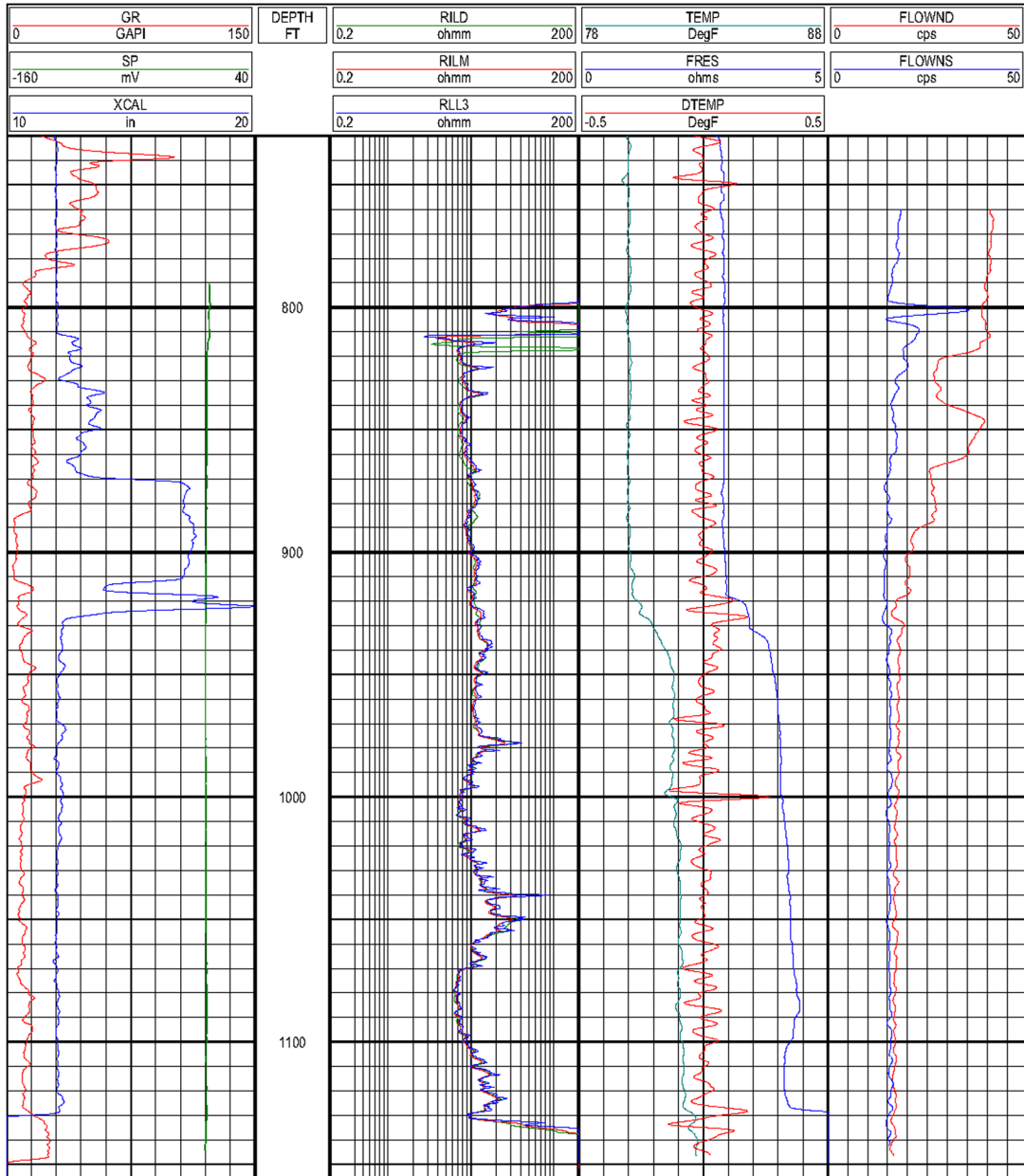

Figure A-5. Geophysical Log Run No. 2 (L2-PW2)

APPENDIX B

LITHOLOGIC DESCRIPTION

Lithologic well printouts are provided in this appendix.

This page is intentionally left blank.

LITHOLOGIC WELL LOG PRINTOUT

SOURCE - FGS

WELL NUMBER: W-17093 COUNTY - HENDRY
 TOTAL DEPTH: 2235 FT. LOCATION: T.45S R.34E S.04
 353 SAMPLES FROM 0 TO 2235 FT. LAT = 26D 36M 30S
 LON = 80D 56M 58S
 COMPLETION DATE: 01/27/94 ELEVATION: 15 FT
 OTHER TYPES OF LOGS AVAILABLE - CALIPER, INDUCTION, GAMMA, NEUTRON,
 SONIC, OT

OWNER/DRILLER: GEOPHYSICAL LOG 0510000019 TO 2200 FEET.
 YOUNGQUIST BROTHERS, INC., DRILLERS
 WORKED BY: JOE AYLOR (6/12/94), 3 TO 10 FOOT SAMPLE INTERVALS
 SFWMD ID# FOR CUTTINGS IS 051-70 (HOLE #L2-TW) HENDRY COUNTY.
 LOCATED IN THE NW 1/4, NW 1/4, NW 1/4, SEC 4, T45S, R34E
 UTM PLANAR, ZONE 17 X=505021.6 Y=2942882.7
 FLORIDA EAST ZONE IN FEET, POLYCONIC PLANAR X=516482; PLANAR Y=826790
 WELL IS LOCATED IN THE LAKE HARBOR SW 7.5 MINUTE QUADRANGLE.
 THE OKEECHOBEE FORMATION IS PROPOSED FOR THE PLIO-PLleistocene INTERVAL
 (SCOTT, 1992, P. 23, FLORIDA GEOLOGICAL SURVEY SPECIAL PUBLICATION 36).

725.	-	730.	000NOSM	NO SAMPLES
742.	-	750.	000NOSM	NO SAMPLES
800.	-	804.	000NOSM	NO SAMPLES
815.	-	825.	000NOSM	NO SAMPLES
990.	-	1010.	000NOSM	NO SAMPLES
0.	-	18.	090UDSS	UNDIFFERENTIATED SAND, CLAY, AND SHELLS
18.	-	195.	121PCPC	PLIOCENE-PLleistocene
195.	-	780.	122HTRN	HAWTHORN GROUP
780.	-	1285.	124OCAL	OCALA GROUP
1285.	-	.	124AVPK	AVON PARK FM.

0 - 9 SAND; DARK YELLOWISH ORANGE
 20% POROSITY: INTERGRANULAR
 GRAIN SIZE: FINE; RANGE: VERY FINE TO VERY COARSE
 ROUNDNESS: ROUNDED TO SUB-ROUNDED; HIGH SPHERICITY
 MODERATE INDURATION
 CEMENT TYPE(S): CALCILUTITE MATRIX
 ACCESSORY MINERALS: LIMESTONE-30%, SHELL-20%
 FOSSILS: MOLLUSKS

9 - 18 SAND; MODERATE LIGHT GRAY
 20% POROSITY: INTERGRANULAR
 GRAIN SIZE: FINE; RANGE: VERY FINE TO MEDIUM
 ROUNDNESS: ROUNDED TO SUB-ROUNDED; MEDIUM SPHERICITY
 POOR INDURATION
 CEMENT TYPE(S): CALCILUTITE MATRIX
 ACCESSORY MINERALS: LIMESTONE-20%, SHELL-20%
 FOSSILS: MOLLUSKS

- 18 - 25 SHELL BED; WHITE
30% POROSITY: INTERGRANULAR; UNCONSOLIDATED
FOSSILS: MOLLUSKS, ECHINOID
GASTROPODS
- 25 - 38 SAND; MODERATE LIGHT GRAY
25% POROSITY: INTERGRANULAR
GRAIN SIZE: FINE; RANGE: VERY FINE TO COARSE
ROUNDNESS: ROUNDED TO SUB-ROUNDED; MEDIUM SPHERICITY
POOR INDURATION
CEMENT TYPE(S): CALCILUTITE MATRIX
ACCESSORY MINERALS: SHELL-30%
GASTROPODS
- 38 - 55 SAND; MODERATE LIGHT GRAY
20% POROSITY: INTERGRANULAR
GRAIN SIZE: FINE; RANGE: VERY FINE TO COARSE
ROUNDNESS: ROUNDED TO SUB-ROUNDED; MEDIUM SPHERICITY
MODERATE INDURATION
CEMENT TYPE(S): CALCILUTITE MATRIX
ACCESSORY MINERALS: SHELL-20%, SPAR-05%
FOSSILS: MOLLUSKS
- 55 - 65 SAND; LIGHT GRAY
20% POROSITY: INTERGRANULAR
GRAIN SIZE: FINE; RANGE: VERY FINE TO COARSE
ROUNDNESS: ROUNDED TO SUB-ROUNDED; MEDIUM SPHERICITY
MODERATE INDURATION
CEMENT TYPE(S): CALCILUTITE MATRIX
ACCESSORY MINERALS: SHELL-20%, PHOSPHATIC SAND-01%
FOSSILS: MOLLUSKS, ECHINOID, FOSSIL MOLDS
GASTROPODS.

- 65 - 70 SAND; LIGHT GRAY
25% POROSITY: INTERGRANULAR
GRAIN SIZE: FINE; RANGE: VERY FINE TO VERY COARSE
ROUNDNESS: SUB-ANGULAR TO SUB-ROUNDED; MEDIUM SPHERICITY
MODERATE INDURATION
CEMENT TYPE(S): CALCILUTITE MATRIX
ACCESSORY MINERALS: SHELL-10%, CALCILUTITE-05%
PHOSPHATIC SAND-01%, SPAR-01%
FOSSILS: MOLLUSKS
- 70 - 75 SAND; LIGHT GRAY
25% POROSITY: INTERGRANULAR
GRAIN SIZE: FINE; RANGE: VERY FINE TO VERY COARSE
ROUNDNESS: SUB-ANGULAR TO SUB-ROUNDED; MEDIUM SPHERICITY
POOR INDURATION
CEMENT TYPE(S): CALCILUTITE MATRIX
ACCESSORY MINERALS: SHELL-30%, CALCILUTITE-10%, SPAR-05%
PHOSPHATIC SAND-02%
FOSSILS: MOLLUSKS, ECHINOID
- 75 - 85 SAND; LIGHT GRAY
20% POROSITY: INTERGRANULAR
GRAIN SIZE: FINE; RANGE: VERY FINE TO COARSE
ROUNDNESS: SUB-ANGULAR TO SUB-ROUNDED; MEDIUM SPHERICITY
POOR INDURATION
CEMENT TYPE(S): CALCILUTITE MATRIX
ACCESSORY MINERALS: SHELL-20%, CALCILUTITE-20%
PHOSPHATIC SAND-%
FOSSILS: MOLLUSKS, ECHINOID
MEDIUM LIGHT GRAY 79 MOLLUSKS.
- 85 - 97 SAND; LIGHT GRAY
20% POROSITY: INTERGRANULAR
GRAIN SIZE: FINE; RANGE: VERY FINE TO COARSE
ROUNDNESS: SUB-ANGULAR TO SUB-ROUNDED; MEDIUM SPHERICITY
MODERATE INDURATION
CEMENT TYPE(S): CALCILUTITE MATRIX
ACCESSORY MINERALS: SHELL-20%, CALCILUTITE-20%
PHOSPHATIC SAND-02%
FOSSILS: MOLLUSKS, ECHINOID
GASTROPODS

- 97 - 115 SAND; VERY LIGHT ORANGE
20% POROSITY: INTERGRANULAR
GRAIN SIZE: FINE; RANGE: VERY FINE TO MEDIUM
ROUNDNESS: ROUNDED TO SUB-ROUNDED; MEDIUM SPHERICITY
POOR INDURATION
CEMENT TYPE(S): CALCILUTITE MATRIX
ACCESSORY MINERALS: CALCILUTITE-25%, SPAR-05%
PHOSPHATIC SAND-02%
FOSSILS: MOLLUSKS, ECHINOID
- 115 - 125 SAND; VERY LIGHT ORANGE
20% POROSITY: INTERGRANULAR
GRAIN SIZE: FINE; RANGE: VERY FINE TO MEDIUM
ROUNDNESS: ROUNDED TO SUB-ROUNDED; MEDIUM SPHERICITY
POOR INDURATION
CEMENT TYPE(S): CALCILUTITE MATRIX
ACCESSORY MINERALS: CALCILUTITE-20%, SPAR-10%
FOSSILS: MOLLUSKS, ECHINOID
- 125 - 130 SAND; VERY LIGHT GRAY
20% POROSITY: INTERGRANULAR
GRAIN SIZE: FINE; RANGE: VERY FINE TO VERY COARSE
ROUNDNESS: ROUNDED TO SUB-ROUNDED; MEDIUM SPHERICITY
MODERATE INDURATION
CEMENT TYPE(S): CALCILUTITE MATRIX
ACCESSORY MINERALS: SHELL-25%, CALCILUTITE-20%
PHOSPHATIC SAND-03%
FOSSILS: MOLLUSKS
- 130 - 135 LIMESTONE; VERY LIGHT ORANGE
20% POROSITY: INTERGRANULAR
GRAIN TYPE: BIOGENIC, CALCILUTITE
85% ALLOCHEMICAL CONSTITUENTS
GRAIN SIZE: VERY FINE; RANGE: MICROCRYSTALLINE TO FINE
POOR INDURATION
CEMENT TYPE(S): CALCILUTITE MATRIX
ACCESSORY MINERALS: QUARTZ-25%, SHELL-10%, SPAR-05%
FOSSILS: MOLLUSKS, BRYOZOA, FOSSIL MOLDS
- 135 - 140 SAND; VERY LIGHT GRAY
20% POROSITY: INTERGRANULAR
GRAIN SIZE: FINE; RANGE: VERY FINE TO MEDIUM
ROUNDNESS: SUB-ANGULAR TO SUB-ROUNDED; MEDIUM SPHERICITY
MODERATE INDURATION
CEMENT TYPE(S): CALCILUTITE MATRIX
ACCESSORY MINERALS: CALCILUTITE-35%, PHOSPHATIC SAND-02%
FOSSILS: MOLLUSKS
GASTROPODS

- 140 - 150 SAND; VERY LIGHT GRAY
20% POROSITY: INTERGRANULAR
GRAIN SIZE: FINE; RANGE: VERY FINE TO MEDIUM
ROUNDNESS: SUB-ANGULAR TO SUB-ROUNDED; MEDIUM SPHERICITY
MODERATE INDURATION
CEMENT TYPE(S): CALCILUTITE MATRIX
ACCESSORY MINERALS: CALCILUTITE-15%, SHELL-10%
PHOSPHATIC SAND-02%
FOSSILS: MOLLUSKS, BRYOZOA, FOSSIL MOLDS
GASTROPODS.
- 150 - 155 SAND; LIGHT GRAY
20% POROSITY: INTERGRANULAR
GRAIN SIZE: FINE; RANGE: VERY FINE TO MEDIUM
ROUNDNESS: SUB-ANGULAR TO SUB-ROUNDED; MEDIUM SPHERICITY
MODERATE INDURATION
CEMENT TYPE(S): CALCILUTITE MATRIX
ACCESSORY MINERALS: SHELL-20%, CALCILUTITE-10%
PHOSPHATIC SAND-02%
FOSSILS: MOLLUSKS, FOSSIL MOLDS
- 155 - 165 CALCILUTITE; WHITE
20% POROSITY: INTERGRANULAR
GRAIN TYPE: BIOGENIC, CALCILUTITE
10% ALLOCHEMICAL CONSTITUENTS
GRAIN SIZE: VERY FINE; RANGE: MICROCRYSTALLINE TO FINE
MODERATE INDURATION
CEMENT TYPE(S): CALCILUTITE MATRIX
ACCESSORY MINERALS: QUARTZ-30%, SHELL-20%, SPAR-05%
PHOSPHATIC SAND-02%
FOSSILS: MOLLUSKS, FOSSIL MOLDS
- 165 - 180 SAND; VERY LIGHT GRAY
20% POROSITY: INTERGRANULAR
GRAIN SIZE: FINE; RANGE: VERY FINE TO MEDIUM
ROUNDNESS: SUB-ANGULAR TO SUB-ROUNDED; MEDIUM SPHERICITY
MODERATE INDURATION
CEMENT TYPE(S): CALCILUTITE MATRIX
ACCESSORY MINERALS: CALCILUTITE-35%, SHELL-10%
PHOSPHATIC SAND-01%
FOSSILS: MOLLUSKS, FOSSIL MOLDS

- 180 - 195 CALCILUTITE; VERY LIGHT GRAY
 20% POROSITY: INTERGRANULAR
 GRAIN TYPE: BIOGENIC, CALCILUTITE
 10% ALLOCHEMICAL CONSTITUENTS
 GRAIN SIZE: VERY FINE; RANGE: MICROCRYSTALLINE TO FINE
 POOR INDURATION
 CEMENT TYPE(S): CALCILUTITE MATRIX
 ACCESSORY MINERALS: QUARTZ-20%
 FOSSILS: MOLLUSKS
- 195 - 200 SILT; LIGHT GREENISH YELLOW TO LIGHT GRAYISH GREEN
 20% POROSITY: INTERGRANULAR; UNCONSOLIDATED
 ACCESSORY MINERALS: CALCILUTITE-20%
 OTHER FEATURES: CALCAREOUS
 TOP OF HAWTHORN GROUP AT 195 FEET, TRANSITION WITHIN THIS
 INTERVAL.
- 200 - 205 SAND; LIGHT OLIVE
 25% POROSITY: INTERGRANULAR
 GRAIN SIZE: VERY FINE; RANGE: MICROCRYSTALLINE TO MEDIUM
 ROUNDNESS: SUB-ANGULAR TO SUB-ROUNDED; MEDIUM SPHERICITY
 UNCONSOLIDATED
 ACCESSORY MINERALS: CALCILUTITE-20%, PHOSPHATIC SAND-02%
 OTHER FEATURES: CALCAREOUS
 FOSSILS: MOLLUSKS
- 205 - 210 SAND; YELLOWISH GRAY
 25% POROSITY: INTERGRANULAR
 GRAIN SIZE: VERY FINE; RANGE: MICROCRYSTALLINE TO MEDIUM
 ROUNDNESS: SUB-ANGULAR TO SUB-ROUNDED; MEDIUM SPHERICITY
 UNCONSOLIDATED
 ACCESSORY MINERALS: CALCILUTITE-30%, PHOSPHATIC SAND-02%
 WHITE CALCILUTITE, PALE OLIVE SAND
- 210 - 225 SAND; LIGHT OLIVE GRAY
 25% POROSITY: INTERGRANULAR
 GRAIN SIZE: VERY FINE; RANGE: MICROCRYSTALLINE TO FINE
 ROUNDNESS: SUB-ANGULAR TO SUB-ROUNDED; MEDIUM SPHERICITY
 UNCONSOLIDATED
 ACCESSORY MINERALS: CALCILUTITE-10%, PHOSPHATIC SAND-02%
 OTHER FEATURES: CALCAREOUS
- 225 - 235 SILT; GRAYISH OLIVE
 20% POROSITY: INTERGRANULAR; UNCONSOLIDATED
 ACCESSORY MINERALS: CALCILUTITE-10%, SHELL-10%
 OTHER FEATURES: CALCAREOUS
 FOSSILS: MOLLUSKS

- 235 - 275 SILT; MODERATE GRAYISH GREEN
20% POROSITY: INTERGRANULAR; UNCONSOLIDATED
ACCESSORY MINERALS: QUARTZ-20%, CALCILUTITE-10%
PHOSPHATIC SAND-02%
OTHER FEATURES: CALCAREOUS
- 275 - 290 SAND; GRAYISH OLIVE
20% POROSITY: INTERGRANULAR
GRAIN SIZE: VERY FINE; RANGE: MICROCRYSTALLINE TO FINE
ROUNDNESS: SUB-ANGULAR TO SUB-ROUNDED; MEDIUM SPHERICITY
UNCONSOLIDATED
ACCESSORY MINERALS: CALCILUTITE-05%, PHOSPHATIC SAND-02%
OTHER FEATURES: CALCAREOUS
FOSSILS: FOSSIL FRAGMENTS
- 290 - 297 SAND; LIGHT OLIVE GRAY
20% POROSITY: INTERGRANULAR
GRAIN SIZE: FINE; RANGE: VERY FINE TO VERY COARSE
ROUNDNESS: SUB-ANGULAR TO SUB-ROUNDED; MEDIUM SPHERICITY
UNCONSOLIDATED
ACCESSORY MINERALS: CALCILUTITE-05%, PHOSPHATIC SAND-02%
OTHER FEATURES: CALCAREOUS
- 297 - 302 SAND; GRAYISH OLIVE
20% POROSITY: INTERGRANULAR
GRAIN SIZE: FINE; RANGE: VERY FINE TO VERY COARSE
ROUNDNESS: SUB-ANGULAR TO SUB-ROUNDED; MEDIUM SPHERICITY
UNCONSOLIDATED
ACCESSORY MINERALS: CALCILUTITE-10%, SHELL-10%
PHOSPHATIC SAND-02%
OTHER FEATURES: CALCAREOUS
FOSSILS: MOLLUSKS
- 302 - 315 SAND; LIGHT OLIVE GRAY
20% POROSITY: INTERGRANULAR
GRAIN SIZE: FINE; RANGE: VERY FINE TO VERY COARSE
ROUNDNESS: SUB-ANGULAR TO SUB-ROUNDED; MEDIUM SPHERICITY
UNCONSOLIDATED
ACCESSORY MINERALS: SHELL-15%, CALCILUTITE-10%
PHOSPHATIC SAND-02%
OTHER FEATURES: CALCAREOUS
FOSSILS: MOLLUSKS

- 315 - 320 SAND; LIGHT OLIVE
 20% POROSITY: INTERGRANULAR
 GRAIN SIZE: FINE; RANGE: VERY FINE TO COARSE
 ROUNDNESS: SUB-ANGULAR TO SUB-ROUNDED; MEDIUM SPHERICITY
 UNCONSOLIDATED
 ACCESSORY MINERALS: QUARTZ-15%, SHELL-10%
 PHOSPHATIC SAND-%
 OTHER FEATURES: CALCAREOUS
 FOSSILS: MOLLUSKS
- 320 - 329 SAND; LIGHT OLIVE GRAY
 25% POROSITY: INTERGRANULAR
 GRAIN SIZE: FINE; RANGE: VERY FINE TO VERY COARSE
 ROUNDNESS: SUB-ANGULAR TO SUB-ROUNDED; MEDIUM SPHERICITY
 UNCONSOLIDATED
 ACCESSORY MINERALS: SHELL-10%, CALCILUTITE-10%
 PHOSPHATIC SAND-%
 OTHER FEATURES: CALCAREOUS
 FOSSILS: MOLLUSKS, FOSSIL FRAGMENTS, FOSSIL MOLDS
- 329 - 345 SILT; YELLOWISH GRAY
 25% POROSITY: INTERGRANULAR; UNCONSOLIDATED
 ACCESSORY MINERALS: SHELL-15%, QUARTZ-10%
 PHOSPHATIC SAND-%
 OTHER FEATURES: CALCAREOUS
 FOSSILS: MOLLUSKS
- 345 - 365 CALCILUTITE; YELLOWISH GRAY TO LIGHT GRAYISH GREEN
 25% POROSITY: INTERGRANULAR
 GRAIN TYPE: BIOGENIC, CALCILUTITE
 10% ALLOCHEMICAL CONSTITUENTS
 GRAIN SIZE: FINE; RANGE: VERY FINE TO MEDIUM
 UNCONSOLIDATED
 ACCESSORY MINERALS: SHELL-40%, QUARTZ-20%, SPAR-05%
 PHOSPHATIC SAND-01%
 FOSSILS: MOLLUSKS, BRYOZOA
- 365 - 375 SILT; LIGHT OLIVE
 25% POROSITY: INTERGRANULAR; UNCONSOLIDATED
 ACCESSORY MINERALS: SHELL-10%

- 375 - 392 SAND; LIGHT OLIVE
 20% POROSITY: INTERGRANULAR
 GRAIN SIZE: VERY FINE; RANGE: MICROCRYSTALLINE TO COARSE
 ROUNDNESS: SUB-ANGULAR TO SUB-ROUNDED; MEDIUM SPHERICITY
 UNCONSOLIDATED
 ACCESSORY MINERALS: SILT-20%, CALCILUTITE-10%
 PHOSPHATIC SAND-01%
 OTHER FEATURES: CALCAREOUS
 FOSSILS: FOSSIL FRAGMENTS
- 392 - 395 SAND; YELLOWISH GRAY
 20% POROSITY: INTERGRANULAR
 GRAIN SIZE: VERY FINE; RANGE: MICROCRYSTALLINE TO COARSE
 ROUNDNESS: SUB-ANGULAR TO SUB-ROUNDED; MEDIUM SPHERICITY
 POOR INDURATION
 CEMENT TYPE(S): CALCILUTITE MATRIX
 ACCESSORY MINERALS: LIMESTONE-35%, SHELL-05%
 PHOSPHATIC SAND-02%
 FOSSILS: MOLLUSKS, FOSSIL FRAGMENTS, ECHINOID
 LIGHT OLIVE GRAY SAND 60%, AND VERY LIGHT GRAY LIMESTONE
 35%.
- 395 - 400 SAND; LIGHT OLIVE GRAY
 20% POROSITY: INTERGRANULAR
 GRAIN SIZE: FINE; RANGE: VERY FINE TO COARSE
 ROUNDNESS: SUB-ANGULAR TO SUB-ROUNDED; MEDIUM SPHERICITY
 UNCONSOLIDATED
 ACCESSORY MINERALS: SHELL-10%, LIMESTONE-05%
 PHOSPHATIC SAND-01%
 OTHER FEATURES: CALCAREOUS
 FOSSILS: MOLLUSKS, FOSSIL FRAGMENTS
- 400 - 412 SAND; GRAYISH OLIVE TO OLIVE GRAY
 20% POROSITY: INTERGRANULAR
 GRAIN SIZE: FINE; RANGE: VERY FINE TO COARSE
 ROUNDNESS: SUB-ANGULAR TO SUB-ROUNDED; MEDIUM SPHERICITY
 UNCONSOLIDATED
 ACCESSORY MINERALS: SHELL-05%, PHOSPHATIC SAND-03%
 OTHER FEATURES: CALCAREOUS
 FOSSILS: MOLLUSKS, FOSSIL FRAGMENTS

- 412 - 413 Limestone; Very Light Gray
20% Porosity: Intergranular
Grain Type: Biogenic, Calcilutite
85% Allochemical Constituents
Grain Size: Very Fine; Range: Microcrystalline to Fine
Poor Induration
Cement Type(s): Calcilutite Matrix
Accessory Minerals: Quartz Sand-20%, Shell-15%
Phosphatic Sand-01%
Fossils: Mollusks, Fossil Fragments, Sharks Teeth
20% Hawthorn Group Sand
- 413 - 420 Silt; Grayish Olive
20% Porosity: Intergranular; Unconsolidated
Accessory Minerals: Shell-20%, Quartz-15%
Phosphatic Sand-01%
Other Features: Calcareous
Fossils: Fossil Fragments
20% White Limestone.
- 420 - 430 Silt; Light Olive to Light Olive Gray
20% Porosity: Intergranular; Unconsolidated
Accessory Minerals: Quartz Sand-20%, Shell-05%
Phosphatic Sand-01%
Other Features: Calcareous
Fossils: Fossil Fragments
- 430 - 435 Silt; Light Greenish Gray
20% Porosity: Intergranular; Unconsolidated
Accessory Minerals: Shell-05%, Phosphatic Sand-01%
Fossils: Mollusks
- 435 - 450 Limestone; Yellowish Gray to Light Greenish Gray
20% Porosity: Intergranular
Grain Type: Biogenic, Calcilutite
85% Allochemical Constituents
Grain Size: Very Fine; Range: Microcrystalline to Fine
Poor Induration
Cement Type(s): Calcilutite Matrix
Accessory Minerals: Shell-05%, Heavy Minerals-01%
Fossils: Mollusks, Fossil Fragments

- 450 - 460 LIMESTONE; LIGHT GREENISH GRAY
 20% POROSITY: INTERGRANULAR
 GRAIN TYPE: BIOGENIC, CALCILUTITE
 85% ALLOCHEMICAL CONSTITUENTS
 GRAIN SIZE: VERY FINE; RANGE: MICROCRYSTALLINE TO FINE
 POOR INDURATION
 CEMENT TYPE(S): CALCILUTITE MATRIX
 ACCESSORY MINERALS: SHELL-20%, HEAVY MINERALS-01%
 FOSSILS: MOLLUSKS, FOSSIL FRAGMENTS, BRYOZOA
- 460 - 465 LIMESTONE; YELLOWISH GRAY
 20% POROSITY: INTERGRANULAR
 GRAIN TYPE: BIOGENIC, CALCILUTITE
 85% ALLOCHEMICAL CONSTITUENTS
 GRAIN SIZE: VERY FINE; RANGE: MICROCRYSTALLINE TO FINE
 POOR INDURATION
 CEMENT TYPE(S): CALCILUTITE MATRIX
 ACCESSORY MINERALS: SHELL-30%, HEAVY MINERALS-%
 FOSSILS: MOLLUSKS, FOSSIL FRAGMENTS, BRYOZOA
- 465 - 470 LIMESTONE; LIGHT GRAYISH GREEN
 20% POROSITY: INTERGRANULAR
 GRAIN TYPE: BIOGENIC, CALCILUTITE
 85% ALLOCHEMICAL CONSTITUENTS
 GRAIN SIZE: VERY FINE; RANGE: MICROCRYSTALLINE TO FINE
 POOR INDURATION
 CEMENT TYPE(S): CALCILUTITE MATRIX
 ACCESSORY MINERALS: SHELL-25%, HEAVY MINERALS-%
 FOSSILS: MOLLUSKS, FOSSIL FRAGMENTS
- 470 - 478 LIMESTONE; YELLOWISH GRAY
 20% POROSITY: INTERGRANULAR
 GRAIN TYPE: BIOGENIC, CALCILUTITE
 85% ALLOCHEMICAL CONSTITUENTS
 GRAIN SIZE: VERY FINE; RANGE: MICROCRYSTALLINE TO FINE
 POOR INDURATION
 CEMENT TYPE(S): CALCILUTITE MATRIX
 ACCESSORY MINERALS: SHELL-25%, HEAVY MINERALS-%
 PHOSPHATIC SAND-%
 FOSSILS: MOLLUSKS, ECHINOID
- 478 - 485 SILT; YELLOWISH GRAY
 20% POROSITY: INTERGRANULAR; POOR INDURATION
 CEMENT TYPE(S): CALCILUTITE MATRIX
 ACCESSORY MINERALS: QUARTZ SAND-25%, CALCILUTITE-25%
 SHELL-10%, HEAVY MINERALS-%
 FOSSILS: FOSSIL FRAGMENTS, ECHINOID

- 485 - 495 SAND; LIGHT GRAYISH GREEN
 20% POROSITY: INTERGRANULAR
 GRAIN SIZE: VERY FINE; RANGE: MICROCRYSTALLINE TO FINE
 ROUNDNESS: SUB-ANGULAR TO SUB-ROUNDED; MEDIUM SPHERICITY
 POOR INDURATION
 CEMENT TYPE(S): CALCILUTITE MATRIX
 ACCESSORY MINERALS: CALCILUTITE-20%, HEAVY MINERALS-%
 FOSSILS: MOLLUSKS, FOSSIL FRAGMENTS, ECHINOID
- 495 - 500 LIMESTONE; YELLOWISH GRAY
 20% POROSITY: INTERGRANULAR
 GRAIN TYPE: BIOGENIC, CALCILUTITE
 85% ALLOCHEMICAL CONSTITUENTS
 GRAIN SIZE: VERY FINE; RANGE: MICROCRYSTALLINE TO FINE
 POOR INDURATION
 CEMENT TYPE(S): CALCILUTITE MATRIX
 ACCESSORY MINERALS: QUARTZ SAND-30%, HEAVY MINERALS-%
 PHOSPHATIC SAND-%
 FOSSILS: MOLLUSKS, FOSSIL FRAGMENTS
- 500 - 515 CALCILUTITE; VERY LIGHT GRAY
 20% POROSITY: INTERGRANULAR
 GRAIN TYPE: BIOGENIC, CALCILUTITE
 10% ALLOCHEMICAL CONSTITUENTS
 GRAIN SIZE: VERY FINE; RANGE: MICROCRYSTALLINE TO FINE
 POOR INDURATION
 CEMENT TYPE(S): CALCILUTITE MATRIX
 ACCESSORY MINERALS: QUARTZ SAND-20%, HEAVY MINERALS-01%
 SHELL-02%
 FOSSILS: MOLLUSKS
- 515 - 530 CALCILUTITE; VERY LIGHT GRAY
 20% POROSITY: INTERGRANULAR
 GRAIN TYPE: BIOGENIC, CALCILUTITE
 10% ALLOCHEMICAL CONSTITUENTS
 GRAIN SIZE: VERY FINE; RANGE: MICROCRYSTALLINE TO FINE
 POOR INDURATION
 CEMENT TYPE(S): CALCILUTITE MATRIX
 ACCESSORY MINERALS: SHELL-10%, HEAVY MINERALS-01%
 FOSSILS: MOLLUSKS, MILIOLIDS

- 530 - 539 CALCILUTITE; YELLOWISH GRAY
20% POROSITY: INTERGRANULAR
GRAIN TYPE: BIOGENIC, CALCILUTITE
10% ALLOCHEMICAL CONSTITUENTS
GRAIN SIZE: VERY FINE; RANGE: MICROCRYSTALLINE TO FINE
POOR INDURATION
CEMENT TYPE(S): CALCILUTITE MATRIX
ACCESSORY MINERALS: SHELL-15%, HEAVY MINERALS-01%
FOSSILS: MOLLUSKS, MILIOLIDS
5% GRAYISH OLIVE SILT
- 539 - 545 CALCILUTITE; YELLOWISH GRAY
20% POROSITY: INTERGRANULAR
GRAIN TYPE: BIOGENIC, CALCILUTITE
10% ALLOCHEMICAL CONSTITUENTS
GRAIN SIZE: VERY FINE; RANGE: MICROCRYSTALLINE TO FINE
POOR INDURATION
CEMENT TYPE(S): CALCILUTITE MATRIX
ACCESSORY MINERALS: SHELL-05%, HEAVY MINERALS-%
PHOSPHATIC SAND-%
FOSSILS: MOLLUSKS, FOSSIL FRAGMENTS
- 545 - 550 CALCILUTITE; WHITE
20% POROSITY: INTERGRANULAR
GRAIN TYPE: BIOGENIC, CALCILUTITE
10% ALLOCHEMICAL CONSTITUENTS
GRAIN SIZE: VERY FINE; RANGE: MICROCRYSTALLINE TO FINE
POOR INDURATION
CEMENT TYPE(S): CALCILUTITE MATRIX
ACCESSORY MINERALS: SHELL-10%, HEAVY MINERALS-%
PHOSPHATIC SAND-%
FOSSILS: MOLLUSKS, FOSSIL FRAGMENTS
- 550 - 555 CALCILUTITE; LIGHT GRAYISH GREEN
20% POROSITY: INTERGRANULAR
GRAIN TYPE: BIOGENIC, CALCILUTITE
10% ALLOCHEMICAL CONSTITUENTS
GRAIN SIZE: VERY FINE; RANGE: MICROCRYSTALLINE TO FINE
POOR INDURATION
CEMENT TYPE(S): CALCILUTITE MATRIX
ACCESSORY MINERALS: SHELL-10%, HEAVY MINERALS-%
PHOSPHATIC SAND-%
FOSSILS: MOLLUSKS, FOSSIL FRAGMENTS

- 555 - 565 CALCILUTITE; YELLOWISH GRAY
20% POROSITY: INTERGRANULAR
GRAIN TYPE: BIOGENIC, CALCILUTITE
10% ALLOCHEMICAL CONSTITUENTS
GRAIN SIZE: VERY FINE; RANGE: MICROCRYSTALLINE TO FINE
POOR INDURATION
CEMENT TYPE(S): CALCILUTITE MATRIX
ACCESSORY MINERALS: SHELL-15%, SILT-15%
FOSSILS: MOLLUSKS, FOSSIL FRAGMENTS, ECHINOID
- 565 - 570 CALCILUTITE; YELLOWISH GRAY
20% POROSITY: INTERGRANULAR
GRAIN TYPE: BIOGENIC, CALCILUTITE
10% ALLOCHEMICAL CONSTITUENTS
GRAIN SIZE: VERY FINE; RANGE: MICROCRYSTALLINE TO FINE
POOR INDURATION
CEMENT TYPE(S): CALCILUTITE MATRIX
ACCESSORY MINERALS: SHELL-20%, SILT-20%
HEAVY MINERALS-%, PHOSPHATIC SAND-%
FOSSILS: MOLLUSKS, FOSSIL FRAGMENTS, BRYOZOA
- 570 - 590 CALCILUTITE; YELLOWISH GRAY
20% POROSITY: INTERGRANULAR
GRAIN TYPE: BIOGENIC, CALCILUTITE
10% ALLOCHEMICAL CONSTITUENTS
GRAIN SIZE: VERY FINE; RANGE: MICROCRYSTALLINE TO FINE
POOR INDURATION
CEMENT TYPE(S): CALCILUTITE MATRIX
ACCESSORY MINERALS: QUARTZ SAND-20%, HEAVY MINERALS-%
PHOSPHATIC SAND-%
FOSSILS: MOLLUSKS, FOSSIL FRAGMENTS, FOSSIL MOLDS
- 590 - 595 CALCILUTITE; WHITE TO YELLOWISH GRAY
20% POROSITY: INTERGRANULAR
GRAIN TYPE: BIOGENIC, CALCILUTITE
10% ALLOCHEMICAL CONSTITUENTS
GRAIN SIZE: VERY FINE; RANGE: MICROCRYSTALLINE TO FINE
POOR INDURATION
CEMENT TYPE(S): CALCILUTITE MATRIX
ACCESSORY MINERALS: SHELL-05%, HEAVY MINERALS-%
PHOSPHATIC SAND-%
FOSSILS: MOLLUSKS, FOSSIL FRAGMENTS, ECHINOID

- 595 - 610 CALCILUTITE; WHITE
20% POROSITY: INTERGRANULAR
GRAIN TYPE: BIOGENIC, CALCILUTITE
10% ALLOCHEMICAL CONSTITUENTS
GRAIN SIZE: VERY FINE; RANGE: MICROCRYSTALLINE TO FINE
POOR INDURATION
CEMENT TYPE(S): CALCILUTITE MATRIX
ACCESSORY MINERALS: SHELL-10%, HEAVY MINERALS-01%
PHOSPHATIC SAND-%
FOSSILS: MOLLUSKS, FOSSIL FRAGMENTS, FOSSIL MOLDS
ECHINOID
- 610 - 615 CALCILUTITE; MODERATE LIGHT GRAY
20% POROSITY: INTERGRANULAR
GRAIN TYPE: BIOGENIC, CALCILUTITE
10% ALLOCHEMICAL CONSTITUENTS
GRAIN SIZE: VERY FINE; RANGE: MICROCRYSTALLINE TO FINE
POOR INDURATION
CEMENT TYPE(S): CALCILUTITE MATRIX
ACCESSORY MINERALS: SHELL-10%, PHOSPHATIC SAND-10%
HEAVY MINERALS-%
FOSSILS: MOLLUSKS, FOSSIL FRAGMENTS, FOSSIL MOLDS
10% PHOSPHATIZED FOSSILS
- 615 - 623 CALCILUTITE; WHITE
20% POROSITY: INTERGRANULAR
GRAIN TYPE: BIOGENIC, CALCILUTITE
10% ALLOCHEMICAL CONSTITUENTS
GRAIN SIZE: VERY FINE; RANGE: MICROCRYSTALLINE TO FINE
POOR INDURATION
CEMENT TYPE(S): CALCILUTITE MATRIX
ACCESSORY MINERALS: SHELL-10%, HEAVY MINERALS-%
PHOSPHATIC SAND-%
FOSSILS: MOLLUSKS, FOSSIL FRAGMENTS
5% PHOSPHATIZED FOSSILS
- 623 - 625 CALCILUTITE; LIGHT OLIVE TO LIGHT OLIVE GRAY
20% POROSITY: INTERGRANULAR
GRAIN TYPE: BIOGENIC, CALCILUTITE
10% ALLOCHEMICAL CONSTITUENTS
GRAIN SIZE: VERY FINE; RANGE: MICROCRYSTALLINE TO FINE
POOR INDURATION
CEMENT TYPE(S): CALCILUTITE MATRIX
ACCESSORY MINERALS: SHELL-10%, SPAR-10%
HEAVY MINERALS-%, PHOSPHATIC SAND-%
FOSSILS: MOLLUSKS, FOSSIL FRAGMENTS

- 625 - 630 CALCILUTITE; WHITE
20% POROSITY: INTERGRANULAR
GRAIN TYPE: BIOGENIC, CALCILUTITE
10% ALLOCHEMICAL CONSTITUENTS
GRAIN SIZE: VERY FINE; RANGE: MICROCRYSTALLINE TO FINE
POOR INDURATION
CEMENT TYPE(S): CALCILUTITE MATRIX
ACCESSORY MINERALS: SHELL-10%
FOSSILS: MOLLUSKS, FOSSIL FRAGMENTS
- 630 - 634 SILT; LIGHT OLIVE
20% POROSITY: INTERGRANULAR; POOR INDURATION
CEMENT TYPE(S): CALCILUTITE MATRIX
ACCESSORY MINERALS: CALCILUTITE-30%, SHELL-05%
PHOSPHATIC SAND-02%, HEAVY MINERALS-%
FOSSILS: MOLLUSKS, FOSSIL FRAGMENTS, BRYOZOA
- 634 - 640 SILT; LIGHT GREENISH GRAY
20% POROSITY: INTERGRANULAR; POOR INDURATION
CEMENT TYPE(S): CALCILUTITE MATRIX
ACCESSORY MINERALS: CALCILUTITE-30%, SHELL-20%
HEAVY MINERALS-%, PHOSPHATIC SAND-%
FOSSILS: MOLLUSKS, FOSSIL FRAGMENTS
- 640 - 662 CALCILUTITE; YELLOWISH GRAY
20% POROSITY: INTERGRANULAR
GRAIN TYPE: BIOGENIC, CALCILUTITE
10% ALLOCHEMICAL CONSTITUENTS
GRAIN SIZE: VERY FINE; RANGE: MICROCRYSTALLINE TO FINE
POOR INDURATION
CEMENT TYPE(S): CALCILUTITE MATRIX
ACCESSORY MINERALS: SHELL-10%, HEAVY MINERALS-%
PHOSPHATIC SAND-%
FOSSILS: MOLLUSKS, FOSSIL FRAGMENTS
- 662 - 685 CALCILUTITE; YELLOWISH GRAY
20% POROSITY: INTERGRANULAR
GRAIN TYPE: BIOGENIC, CALCILUTITE
10% ALLOCHEMICAL CONSTITUENTS
GRAIN SIZE: VERY FINE; RANGE: MICROCRYSTALLINE TO FINE
POOR INDURATION
CEMENT TYPE(S): CALCILUTITE MATRIX
ACCESSORY MINERALS: SHELL-25%, HEAVY MINERALS-%
PHOSPHATIC SAND-%
FOSSILS: MOLLUSKS, FOSSIL FRAGMENTS, BRYOZOA
10% BRYOZOAN

685 - 695 CALCILUTITE; WHITE
 20% POROSITY: INTERGRANULAR
 GRAIN TYPE: BIOGENIC, CALCILUTITE
 10% ALLOCHEMICAL CONSTITUENTS
 GRAIN SIZE: VERY FINE; RANGE: MICROCRYSTALLINE TO FINE
 POOR INDURATION
 CEMENT TYPE(S): CALCILUTITE MATRIX
 ACCESSORY MINERALS: SHELL-10%, SPAR-10%
 HEAVY MINERALS-%, PHOSPHATIC SAND-%
 FOSSILS: MOLLUSKS, FOSSIL FRAGMENTS, ECHINOID

695 - 700 CALCILUTITE; VERY LIGHT GRAY
 20% POROSITY: INTERGRANULAR
 GRAIN TYPE: BIOGENIC, CALCILUTITE
 10% ALLOCHEMICAL CONSTITUENTS
 GRAIN SIZE: VERY FINE; RANGE: MICROCRYSTALLINE TO FINE
 POOR INDURATION
 CEMENT TYPE(S): CALCILUTITE MATRIX
 ACCESSORY MINERALS: SHELL-05%, HEAVY MINERALS-%
 FOSSILS: MOLLUSKS, FOSSIL FRAGMENTS

700 - 703 NO SAMPLES

703 - 708 CALCILUTITE; VERY LIGHT GRAY
 20% POROSITY: INTERGRANULAR
 GRAIN TYPE: BIOGENIC, CALCILUTITE
 10% ALLOCHEMICAL CONSTITUENTS
 GRAIN SIZE: VERY FINE; RANGE: MICROCRYSTALLINE TO FINE
 POOR INDURATION
 CEMENT TYPE(S): CALCILUTITE MATRIX
 ACCESSORY MINERALS: SHELL-05%, HEAVY MINERALS-%
 FOSSILS: MOLLUSKS, FOSSIL FRAGMENTS

708 - 715 CALCILUTITE; WHITE TO VERY LIGHT GRAY
 20% POROSITY: INTERGRANULAR
 GRAIN TYPE: BIOGENIC, CALCILUTITE
 10% ALLOCHEMICAL CONSTITUENTS
 GRAIN SIZE: VERY FINE; RANGE: MICROCRYSTALLINE TO FINE
 POOR INDURATION
 CEMENT TYPE(S): CALCILUTITE MATRIX
 ACCESSORY MINERALS: SHELL-10%, SPAR-05%
 HEAVY MINERALS-%
 FOSSILS: MOLLUSKS, FOSSIL FRAGMENTS
 GASTROPODS

715 - 725 CALCILUTITE; WHITE
20% POROSITY: INTERGRANULAR
GRAIN TYPE: BIOGENIC, CALCILUTITE
10% ALLOCHEMICAL CONSTITUENTS
GRAIN SIZE: VERY FINE; RANGE: MICROCRYSTALLINE TO FINE
POOR INDURATION
CEMENT TYPE(S): CALCILUTITE MATRIX
ACCESSORY MINERALS: SHELL-10%, HEAVY MINERALS-01%
PHOSPHATIC SAND-01%
FOSSILS: MOLLUSKS, FOSSIL FRAGMENTS

725 - 730 NO SAMPLES

730 - 742 CALCILUTITE; VERY LIGHT GRAY
20% POROSITY: INTERGRANULAR
GRAIN TYPE: BIOGENIC, CALCILUTITE
10% ALLOCHEMICAL CONSTITUENTS
GRAIN SIZE: VERY FINE; RANGE: MICROCRYSTALLINE TO FINE
POOR INDURATION
CEMENT TYPE(S): CALCILUTITE MATRIX
ACCESSORY MINERALS: SHELL-10%, HEAVY MINERALS-01%
PHOSPHATIC SAND-01%
FOSSILS: MOLLUSKS, FOSSIL FRAGMENTS
5% MEDIUM LIGHT GRAY CALCAREOUS SAND

742 - 750 NO SAMPLES

750 - 770 SAND; YELLOWISH GRAY TO DARK GRAYISH YELLOW
20% POROSITY: INTERGRANULAR
GRAIN SIZE: VERY FINE; RANGE: MICROCRYSTALLINE TO FINE
ROUNDNESS: SUB-ANGULAR TO SUB-ROUNDED; MEDIUM SPHERICITY
POOR INDURATION
CEMENT TYPE(S): CALCILUTITE MATRIX
ACCESSORY MINERALS: CALCILUTITE-20%, PHOSPHATIC SAND-02%
HEAVY MINERALS-%, LIMONITE-%

770 - 780 SILT; LIGHT OLIVE
20% POROSITY: INTERGRANULAR; POOR INDURATION
CEMENT TYPE(S): CALCILUTITE MATRIX
ACCESSORY MINERALS: CALCILUTITE-30%, QUARTZ SAND-20%
LIMONITE-%
FOSSILS: FOSSIL FRAGMENTS, BRYOZOA

780 - 790 CALCILUTITE; YELLOWISH GRAY
 20% POROSITY: INTERGRANULAR
 GRAIN TYPE: BIOGENIC, CALCILUTITE
 10% ALLOCHEMICAL CONSTITUENTS
 GRAIN SIZE: VERY FINE; RANGE: MICROCRYSTALLINE TO FINE
 POOR INDURATION
 CEMENT TYPE(S): CALCILUTITE MATRIX
 ACCESSORY MINERALS: HEAVY MINERALS-%
 PHOSPHATIC SAND-%
 FOSSILS: BENTHIC FORAMINIFERA
 5% MEDIUM LIGHT GRAY LIMESTONE, NUMMULITES SP., TOP OF
 OCALA AT 780 FEET.

790 - 800 CALCILUTITE; WHITE
 20% POROSITY: INTERGRANULAR
 GRAIN TYPE: BIOGENIC, CALCILUTITE
 10% ALLOCHEMICAL CONSTITUENTS
 GRAIN SIZE: VERY FINE; RANGE: MICROCRYSTALLINE TO FINE
 POOR INDURATION
 CEMENT TYPE(S): CALCILUTITE MATRIX
 FOSSILS: BENTHIC FORAMINIFERA, ECHINOID, BRYOZOA
 5% MEDIUM LIGHT GRAY LIMESTONE, NUMMULITES SP.

800 - 804 NO SAMPLES

804 - 815 LIMESTONE; WHITE
 20% POROSITY: INTERGRANULAR
 GRAIN TYPE: BIOGENIC, CALCILUTITE
 75% ALLOCHEMICAL CONSTITUENTS
 GRAIN SIZE: VERY FINE; RANGE: MICROCRYSTALLINE TO FINE
 POOR INDURATION
 CEMENT TYPE(S): CALCILUTITE MATRIX
 ACCESSORY MINERALS: SPAR-10%
 FOSSILS: BENTHIC FORAMINIFERA, MILIOLIDS
 5% MEDIUM LIGHT GRAY LIMESTONE, NUMMULITES SP.
 LEPIDOCYCLINA SP.

815 - 825 NO SAMPLES

- 825 - 855 Limestone; white to very light gray
20% porosity: intergranular
grain type: biogenic, calcilutite
85% allochemical constituents
grain size: very fine; range: microcrystalline to fine
poor induration
cement type(s): calcilutite matrix
accessory minerals: spar-10%
fossils: benthic foraminifera, miliolids, echinoid
mollusks
5% medium light gray limestone, nummulites sp.
lepidocyclina sp.
- 855 - 877 Limestone; white
20% porosity: intergranular
grain type: biogenic, calcilutite
85% allochemical constituents
grain size: very fine; range: microcrystalline to fine
poor induration
cement type(s): calcilutite matrix
fossils: benthic foraminifera, miliolids
10% medium light gray dolostone, nummulites sp. 20%
lepidocyclina sp.
- 877 - 889 Limestone; white
20% porosity: intergranular
grain type: biogenic, calcilutite
75% allochemical constituents
grain size: very fine; range: microcrystalline to fine
poor induration
cement type(s): calcilutite matrix
accessory minerals: spar-05%
fossils: benthic foraminifera, miliolids
1% medium light gray dolostone, miliolid forams 80%
nummulites sp. 10%, heterostegina sp.
- 889 - 905 Limestone; very light orange
20% porosity: intergranular
grain type: biogenic, calcilutite
85% allochemical constituents
grain size: very fine; range: microcrystalline to fine
poor induration
cement type(s): calcilutite matrix
accessory minerals: spar-30%
fossils: mollusks, benthic foraminifera, miliolids
bryozoa
nummulites sp., gypsina globula, heterostegina sp.
miliolid forams 65%.

- 905 - 915 Limestone; Very Light Orange
20% Porosity: Intergranular
Grain Type: Biogenic, Calcilutite
85% Allochemical Constituents
Grain Size: Very Fine; Range: Microcrystalline to Fine
Poor Induration
Cement Type(s): Calcilutite Matrix
Accessory Minerals: Spar-10%, Calcilutite-20%
Fossils: Mollusks, Fossil Fragments, Miliolids
2% Medium Light Gray Dolostone, Miliolid Forams 50%.
- 915 - 935 Limestone; Very Light Orange
20% Porosity: Intergranular
Grain Type: Biogenic, Calcilutite
80% Allochemical Constituents
Grain Size: Very Fine; Range: Microcrystalline to Fine
Poor Induration
Cement Type(s): Calcilutite Matrix
Accessory Minerals: Spar-15%, Calcilutite-15%
Fossils: Mollusks, Fossil Fragments, Miliolids, Bryozoa
Miliolid Forams 70%, Nummulites sp., 5% Greenish Gray to
Light Olive Gray Sand and Silt.
- 935 - 945 Limestone; Very Light Orange
20% Porosity: Intergranular
Grain Type: Biogenic, Calcilutite
75% Allochemical Constituents
Grain Size: Very Fine; Range: Microcrystalline to Fine
Poor Induration
Cement Type(s): Calcilutite Matrix
Accessory Minerals: Spar-05%
Fossils: Mollusks, Fossil Fragments, Miliolids, Echinoid
Benthic Foraminifera
Miliolid Forams 80%, Nummulites sp., 5% Greenish Gray to
Light Olive Gray Dolostone.
- 945 - 970 Limestone; Very Light Orange
20% Porosity: Intergranular
Grain Type: Biogenic, Calcilutite
75% Allochemical Constituents
Grain Size: Very Fine; Range: Microcrystalline to Fine
Poor Induration
Cement Type(s): Calcilutite Matrix
Accessory Minerals: Spar-05%
Fossils: Mollusks, Fossil Fragments, Miliolids, Echinoid
Miliolid Forams 80%, 1% Medium Light Gray Dolostone

- 970 - 990 Limestone; VERY LIGHT ORANGE
20% POROSITY: INTERGRANULAR
GRAIN TYPE: BIOGENIC, CALCILUTITE
85% ALLOCHEMICAL CONSTITUENTS
GRAIN SIZE: VERY FINE; RANGE: MICROCRYSTALLINE TO FINE
POOR INDURATION
CEMENT TYPE(S): CALCILUTITE MATRIX
ACCESSORY MINERALS: SPAR-15%, SHELL-05%
FOSSILS: MOLLUSKS, FOSSIL FRAGMENTS, MILIOLIDS, BRYOZOA
MILIOLID FORAMS 70%
- 990 - 1010 NO SAMPLES
- 1010 - 1025 Limestone; VERY LIGHT ORANGE
20% POROSITY: INTERGRANULAR
GRAIN TYPE: BIOGENIC, CALCILUTITE
85% ALLOCHEMICAL CONSTITUENTS
GRAIN SIZE: VERY FINE; RANGE: MICROCRYSTALLINE TO FINE
POOR INDURATION
CEMENT TYPE(S): CALCILUTITE MATRIX
ACCESSORY MINERALS: SPAR-40%
FOSSILS: MILIOLIDS, BENTHIC FORAMINIFERA, BRYOZOA
ECHINOID
MILIOLID FORAMS 40%, 1% MEDIUM LIGHT GRAY DOLOSTONE
NUMMULITES SP. SEA URCHIN DISC.
- 1025 - 1040 Limestone; VERY LIGHT ORANGE
20% POROSITY: INTERGRANULAR
GRAIN TYPE: BIOGENIC, CALCILUTITE
85% ALLOCHEMICAL CONSTITUENTS
GRAIN SIZE: VERY FINE; RANGE: MICROCRYSTALLINE TO FINE
POOR INDURATION
CEMENT TYPE(S): CALCILUTITE MATRIX
ACCESSORY MINERALS: SPAR-30%
FOSSILS: ECHINOID, MILIOLIDS
SEA URCHIN DISCS 15%.
- 1040 - 1060 Limestone; VERY LIGHT ORANGE
20% POROSITY: INTERGRANULAR
GRAIN TYPE: BIOGENIC, CALCILUTITE
75% ALLOCHEMICAL CONSTITUENTS
GRAIN SIZE: VERY FINE; RANGE: MICROCRYSTALLINE TO FINE
POOR INDURATION
CEMENT TYPE(S): CALCILUTITE MATRIX
ACCESSORY MINERALS: SPAR-40%, CALCILUTITE-20%
FOSSILS: ECHINOID, MILIOLIDS
SEA URCHIN DISCS 20%, MILIOLID FORMAS 40%, RECRYSTALLIZED
ECHINOIDS

- 1060 - 1085 Limestone; Very Light Orange
20% Porosity: Intergranular
Grain Type: Biogenic, Calcilutite
85% Allochemical Constituents
Grain Size: Very Fine; Range: Microcrystalline to Fine
Poor Induration
Cement Type(s): Calcilutite Matrix
Accessory Minerals: Spar-25%
Fossils: Echinoid, Miliolids
Miliolid Formas 50%.
- 1085 - 1095 Limestone; Very Light Orange
20% Porosity: Intergranular
Grain Type: Biogenic, Calcilutite
85% Allochemical Constituents
Grain Size: Very Fine; Range: Microcrystalline to Fine
Poor Induration
Cement Type(s): Calcilutite Matrix
Accessory Minerals: Spar-20%
Fossils: Fossil Fragments, Echinoid
Sea Urchin Discs 20%, Miliolid Forams 70%
- 1095 - 1108 Limestone; Very Light Orange
20% Porosity: Intergranular
Grain Type: Biogenic, Calcilutite
85% Allochemical Constituents
Grain Size: Very Fine; Range: Microcrystalline to Fine
Poor Induration
Cement Type(s): Calcilutite Matrix
Accessory Minerals: Spar-40%
Fossils: Cones, Benthic Foraminifera, Miliolids
Dictyoconus Cookei, 2% Medium Gray Dolostone, Miliolid
Forams 60%.
- 1108 - 1115 Limestone; Very Light Orange
20% Porosity: Intergranular
Grain Type: Biogenic, Calcilutite
85% Allochemical Constituents
Grain Size: Very Fine; Range: Microcrystalline to Fine
Poor Induration
Cement Type(s): Calcilutite Matrix
Accessory Minerals: Spar-20%
Fossils: Miliolids
Miliolid Forams 80%, Light Gray Limestone 20%

- 1115 - 1135 Limestone; Very Light Orange
20% Porosity: Intergranular
Grain Type: Biogenic, Calcilutite
85% Allochemical Constituents
Grain Size: Very Fine; Range: Microcrystalline to Fine
Poor Induration
Cement Type(s): Calcilutite Matrix
Accessory Minerals: Spar-20%
Fossils: Miliolids, Echinoid, Benthic Foraminifera
Sea Urchin Fragments, Dictyoconus Cookei.
- 1135 - 1150 Limestone; Very Light Orange
20% Porosity: Intergranular
Grain Type: Biogenic, Calcilutite
85% Allochemical Constituents
Grain Size: Very Fine; Range: Microcrystalline to Fine
Poor Induration
Cement Type(s): Calcilutite Matrix
Accessory Minerals: Spar-10%
Fossils: Miliolids
Miliolid Forams 60%
- 1150 - 1165 Limestone; Very Light Orange
20% Porosity: Intergranular
Grain Type: Biogenic, Calcilutite
85% Allochemical Constituents
Grain Size: Very Fine; Range: Microcrystalline to Fine
Poor Induration
Cement Type(s): Calcilutite Matrix
Accessory Minerals: Spar-30%
Fossils: Miliolids, Echinoid, Benthic Foraminifera
Fossil Fragments, Cones
Milioid Forams 50%, 5% Sea Urchin Disc Fragments, 1% Light
Gray Dolostone, Dictyoconus Cookei.
- 1165 - 1185 Limestone; Grayish Orange to Moderate Yellowish Green
20% Porosity: Intergranular
Grain Type: Biogenic, Calcilutite
85% Allochemical Constituents
Grain Size: Very Fine; Range: Microcrystalline to Fine
Poor Induration
Cement Type(s): Calcilutite Matrix
Accessory Minerals: Spar-20%
Other Features: High Recrystallization
Fossils: Miliolids, Cones, Echinoid
Dictyoconus Cookei, Echinoid Stems

- 1185 - 1203 Limestone; VERY LIGHT ORANGE
 20% POROSITY: INTERGRANULAR
 GRAIN TYPE: BIOGENIC, CALCILUTITE
 85% ALLOCHEMICAL CONSTITUENTS
 GRAIN SIZE: VERY FINE; RANGE: MICROCRYSTALLINE TO FINE
 POOR INDURATION
 CEMENT TYPE(S): CALCILUTITE MATRIX
 SEDIMENTARY STRUCTURES: MASSIVE
 ACCESSORY MINERALS: SPAR-20%
 OTHER FEATURES: HIGH RECRYSTALLIZATION
 FOSSILS: MILIOLIDS, CONES
 MILIOLID FORAMS 30%, 40% FINE LIMESTONE, DICTYOCONUS
 COOKEI
- 1203 - 1224 Limestone; WHITE
 20% POROSITY: INTERGRANULAR
 GRAIN TYPE: BIOGENIC, CALCILUTITE
 75% ALLOCHEMICAL CONSTITUENTS
 GRAIN SIZE: VERY FINE; RANGE: MICROCRYSTALLINE TO FINE
 POOR INDURATION
 CEMENT TYPE(S): CALCILUTITE MATRIX
 ACCESSORY MINERALS: CALCILUTITE-20%, SPAR-20%
 OTHER FEATURES: MEDIUM RECRYSTALLIZATION
 FOSSILS: ECHINOID, MILIOLIDS
 MILIOLID FORAMS 80%, ECHINOID SEA URCHINS AND STEMS
- 1224 - 1226 CALCILUTITE; LIGHT GRAY
 20% POROSITY: INTERGRANULAR
 GRAIN TYPE: BIOGENIC, CALCILUTITE
 10% ALLOCHEMICAL CONSTITUENTS
 GRAIN SIZE: VERY FINE; RANGE: MICROCRYSTALLINE TO FINE
 POOR INDURATION
 CEMENT TYPE(S): CALCILUTITE MATRIX
 ACCESSORY MINERALS: LIMESTONE-40%, SPAR-10%
 OTHER FEATURES: MEDIUM RECRYSTALLIZATION
 FOSSILS: MILIOLIDS
 40% WHITE LIMESTONE
- 1226 - 1255 Limestone; VERY LIGHT ORANGE
 20% POROSITY: INTERGRANULAR
 GRAIN TYPE: BIOGENIC, CALCILUTITE
 85% ALLOCHEMICAL CONSTITUENTS
 GRAIN SIZE: VERY FINE; RANGE: MICROCRYSTALLINE TO FINE
 POOR INDURATION
 CEMENT TYPE(S): CALCILUTITE MATRIX
 ACCESSORY MINERALS: SPAR-20%, CALCILUTITE-10%
 OTHER FEATURES: MEDIUM RECRYSTALLIZATION
 FOSSILS: MILIOLIDS, ECHINOID, CONES
 MILIOLID FORAMS 80%, DICTYOCONUS COOKEI.

- 1255 - 1275 Limestone; very light orange
20% porosity: intergranular
grain type: biogenic, calcilutite
85% allochemical constituents
grain size: very fine; range: microcrystalline to fine
poor induration
cement type(s): calcilutite matrix
accessory minerals: spar-20%
other features: medium recrystallization
fossils: miliolids, echinoid, mollusks, cones
miliolid forams 70%, 1 cm diameter echinoid sea urchins 2%
dictyoconus cookei, gastropods.
- 1275 - 1295 Limestone; very light orange to white
20% porosity: intergranular
grain type: biogenic, calcilutite
85% allochemical constituents
grain size: very fine; range: microcrystalline to fine
poor induration
cement type(s): calcilutite matrix
accessory minerals: spar-20%, calcilutite-10%
other features: medium recrystallization
fossils: miliolids, cones
lithionelli floridanna, dictyoconus cookei 3%, (top of
Avon Park at 1285 feet), miliolid forams 80%.
- 1295 - 1305 Limestone; very light orange
20% porosity: intergranular
grain type: biogenic, calcilutite
85% allochemical constituents
grain size: very fine; range: microcrystalline to fine
poor induration
cement type(s): calcilutite matrix
accessory minerals: spar-20%
other features: medium recrystallization
fossils: miliolids, cones
cribrotulimina cushmani, litiuonella floridana, miliolid
forams 80%.

- 1305 - 1320 Limestone; WHITE
20% POROSITY: INTERGRANULAR
GRAIN TYPE: BIOGENIC, CALCILUTITE
75% ALLOCHEMICAL CONSTITUENTS
GRAIN SIZE: VERY FINE; RANGE: MICROCRYSTALLINE TO FINE
POOR INDURATION
CEMENT TYPE(S): CALCILUTITE MATRIX
ACCESSORY MINERALS: SPAR-10%, CALCILUTITE-20%
OTHER FEATURES: MEDIUM RECRYSTALLIZATION
FOSSILS: MILIOLIDS, CONES, ECHINOID
MILIOLID FORAMS 75%, DICTYOCONUS COOKEI 2%, SEA URCHIN
FRAGMENTS.
- 1320 - 1337 Limestone; VERY LIGHT ORANGE
20% POROSITY: INTERGRANULAR
GRAIN TYPE: BIOGENIC, CALCILUTITE
85% ALLOCHEMICAL CONSTITUENTS
GRAIN SIZE: VERY FINE; RANGE: MICROCRYSTALLINE TO FINE
POOR INDURATION
CEMENT TYPE(S): CALCILUTITE MATRIX
ACCESSORY MINERALS: SPAR-20%, CALCILUTITE-10%
OTHER FEATURES: MEDIUM RECRYSTALLIZATION
FOSSILS: MILIOLIDS, CONES
MILIOLID FORAMS 75%, SEA URCHIN FRAGMENTS, DICTYOCONUS
COOKEI 3%, CRIBROBULIMINA CUSHMANI, D. AMERICANUS.
- 1337 - 1368 Limestone; VERY LIGHT ORANGE
20% POROSITY: INTERGRANULAR
GRAIN TYPE: BIOGENIC, CALCILUTITE
75% ALLOCHEMICAL CONSTITUENTS
GRAIN SIZE: VERY FINE; RANGE: MICROCRYSTALLINE TO FINE
POOR INDURATION
CEMENT TYPE(S): CALCILUTITE MATRIX
ACCESSORY MINERALS: CALCILUTITE-20%
OTHER FEATURES: MEDIUM RECRYSTALLIZATION
FOSSILS: MILIOLIDS
MILIOLID FORAMS 65%, ECHINOID SEA URCHINS 1 CM IN DIAMETER
25% FINE LIMESTONE.

- 1368 - 1380 LIMESTONE; GRAYISH ORANGE PINK TO LIGHT GRAY
25% POROSITY: INTERGRANULAR
GRAIN TYPE: BIOGENIC, CALCILUTITE
85% ALLOCHEMICAL CONSTITUENTS
GRAIN SIZE: VERY FINE; RANGE: MICROCRYSTALLINE TO MEDIUM
POOR INDURATION
CEMENT TYPE(S): CALCILUTITE MATRIX
ACCESSORY MINERALS: CALCILUTITE-10%, SPAR-10%
OTHER FEATURES: MEDIUM RECRYSTALLIZATION
FOSSILS: MILIOLIDS, BENTHIC FORAMINIFERA
20% FINE LIMESTONE, 60% MILIOLID FORAMS
- 1380 - 1400 LIMESTONE; VERY LIGHT ORANGE
20% POROSITY: INTERGRANULAR
GRAIN TYPE: BIOGENIC, CALCILUTITE
85% ALLOCHEMICAL CONSTITUENTS
GRAIN SIZE: VERY FINE; RANGE: MICROCRYSTALLINE TO MEDIUM
POOR INDURATION
CEMENT TYPE(S): CALCILUTITE MATRIX
ACCESSORY MINERALS: CALCILUTITE-10%, SPAR-20%
OTHER FEATURES: LOW RECRYSTALLIZATION, REEFAL
FOSSILS: MILIOLIDS, BENTHIC FORAMINIFERA, ECHINOID, CORAL
MOLLUSKS
MILIOLID FORAMS 75%, 2% LIGHT GRAY DOLOSTONE, REEFAL (?)
- 1400 - 1414 LIMESTONE; GRAYISH ORANGE PINK TO LIGHT GRAY
20% POROSITY: INTERGRANULAR
GRAIN TYPE: BIOGENIC, CALCILUTITE
85% ALLOCHEMICAL CONSTITUENTS
GRAIN SIZE: VERY FINE; RANGE: MICROCRYSTALLINE TO MEDIUM
POOR INDURATION
CEMENT TYPE(S): CALCILUTITE MATRIX
ACCESSORY MINERALS: CALCILUTITE-10%, SPAR-10%
OTHER FEATURES: LOW RECRYSTALLIZATION
FOSSILS: MILIOLIDS, BENTHIC FORAMINIFERA
MILIOLID FORAMS 65%, 15% VERY LIGHT GRAY FINE LIMESTONE,
5% MEDIUM LIGHT GRAY DOLOSTONE.

- 1414 - 1435 Limestone; VERY LIGHT ORANGE
20% POROSITY: INTERGRANULAR
GRAIN TYPE: BIOGENIC, CALCILUTITE
75% ALLOCHEMICAL CONSTITUENTS
GRAIN SIZE: VERY FINE; RANGE: MICROCRYSTALLINE TO MEDIUM
POOR INDURATION
CEMENT TYPE(S): CALCILUTITE MATRIX
ACCESSORY MINERALS: SPAR-10%
OTHER FEATURES: LOW RECRYSTALLIZATION
FOSSILS: MILIOLIDS, BENTHIC FORAMINIFERA, CONES
3% MEDIUM GRAY DOLOSTONE, MILIOLID FORAMS 60%, LITUNELLA
FLORIDANA, NUMMULITES SP., DICTYOCONUS COOKEI.
- 1435 - 1445 Limestone; VERY LIGHT ORANGE
20% POROSITY: INTERGRANULAR
GRAIN TYPE: BIOGENIC, CALCILUTITE
85% ALLOCHEMICAL CONSTITUENTS
GRAIN SIZE: VERY FINE; RANGE: MICROCRYSTALLINE TO MEDIUM
POOR INDURATION
CEMENT TYPE(S): CALCILUTITE MATRIX
ACCESSORY MINERALS: SPAR-10%
OTHER FEATURES: LOW RECRYSTALLIZATION
FOSSILS: MILIOLIDS, BENTHIC FORAMINIFERA
MILIOLID FORAMS 80%, 1% MEDIUM GRAY DOLOSTONE.
- 1445 - 1460 Limestone; VERY LIGHT GRAY
20% POROSITY: INTERGRANULAR
GRAIN TYPE: BIOGENIC, CALCILUTITE
70% ALLOCHEMICAL CONSTITUENTS
GRAIN SIZE: VERY FINE; RANGE: MICROCRYSTALLINE TO MEDIUM
POOR INDURATION
CEMENT TYPE(S): CALCILUTITE MATRIX
ACCESSORY MINERALS: CALCILUTITE-20%, SPAR-10%
OTHER FEATURES: LOW RECRYSTALLIZATION
FOSSILS: MILIOLIDS, ECHINOID
MILIOLID FORAMS 85%, ECHINOID STEMS, 2% MEDIUM GRAY
DOLOSTONE, 10% FINE LIMESTONE.
- 1460 - 1465 DOLOSTONE; GRAYISH BROWN TO LIGHT BROWNISH GRAY
20% POROSITY: INTERGRANULAR; 50-90% ALTERED; SUBHEDRAL
GRAIN SIZE: VERY FINE; RANGE: MICROCRYSTALLINE TO MEDIUM
POOR INDURATION
CEMENT TYPE(S): CALCILUTITE MATRIX
ACCESSORY MINERALS: CALCILUTITE-10%, SPAR-20%
OTHER FEATURES: MEDIUM RECRYSTALLIZATION
FOSSILS: MILIOLIDS
MILIOLID FORAMS 40% IN WHITE LIMESTONE, FINE PALE
YELLOWISH- BROWN DOLOSTONE, 2% MEDIUM GRAY DOLOSTONE.

- 1465 - 1489 Limestone; VERY LIGHT ORANGE TO PINKISH GRAY
20% POROSITY: INTERGRANULAR
GRAIN TYPE: BIOGENIC, CALCILUTITE
75% ALLOCHEMICAL CONSTITUENTS
GRAIN SIZE: VERY FINE; RANGE: MICROCRYSTALLINE TO MEDIUM
POOR INDURATION
CEMENT TYPE(S): CALCILUTITE MATRIX
ACCESSORY MINERALS: CALCILUTITE-10%, SPAR-10%
DOLOMITE-%
OTHER FEATURES: LOW RECRYSTALLIZATION
FOSSILS: MILIOLIDS
MILIOLID FORAMS 80%, MINOR GRAY DOLOSTONE
- 1489 - 1490 Limestone; LIGHT GRAYISH BROWN TO MODERATE GRAY
20% POROSITY: INTERGRANULAR
GRAIN TYPE: BIOGENIC, CALCILUTITE
75% ALLOCHEMICAL CONSTITUENTS
GRAIN SIZE: VERY FINE; RANGE: MICROCRYSTALLINE TO MEDIUM
POOR INDURATION
CEMENT TYPE(S): CALCILUTITE MATRIX
ACCESSORY MINERALS: PEAT-20%
FOSSILS: ORGANICS, CONES, BENTHIC FORAMINIFERA
20% BLACK ORGANICS, DICTYOCONUS COOKEI 1%, D. AMERICANUS
2%.
- 1490 - 1552 Limestone; VERY LIGHT ORANGE
20% POROSITY: INTERGRANULAR
GRAIN TYPE: BIOGENIC, CALCILUTITE
85% ALLOCHEMICAL CONSTITUENTS
GRAIN SIZE: VERY FINE; RANGE: MICROCRYSTALLINE TO MEDIUM
POOR INDURATION
CEMENT TYPE(S): CALCILUTITE MATRIX
ACCESSORY MINERALS: SPAR-20%
OTHER FEATURES: MEDIUM RECRYSTALLIZATION
FOSSILS: MILIOLIDS, BENTHIC FORAMINIFERA, CONES
MEDIUM GRAY DOLOSTONE 6%, MILIOLID FORAMS 80%, DICTYOCONUS
COOKEI.
- 1552 - 1560 Limestone; GRAYISH ORANGE
15% POROSITY: INTERGRANULAR
GRAIN TYPE: BIOGENIC, CALCILUTITE
85% ALLOCHEMICAL CONSTITUENTS
GRAIN SIZE: VERY FINE; RANGE: FINE TO VERY COARSE
POOR INDURATION
CEMENT TYPE(S): CALCILUTITE MATRIX
ACCESSORY MINERALS: SPAR-50%
OTHER FEATURES: HIGH RECRYSTALLIZATION
FOSSILS: BENTHIC FORAMINIFERA, CONES, ECHINOID
DICTYOCONUS COOKEI, SEA URCHINS.

- 1560 - 1570 Limestone; Very Light Orange
20% Porosity: Intergranular
Grain Type: Biogenic, Calcilutite
85% Allochemical Constituents
Grain Size: Very Fine; Range: Fine to Medium
Poor Induration
Cement Type(s): Calcilutite Matrix
Accessory Minerals: Spar-20%
Other Features: Low Recrystallization
Fossils: Miliolids
Dictyoconus americanus 1% some inverted with "dimples,"
Nummulites sp.
- 1570 - 1607 Limestone; Very Light Orange
20% Porosity: Intergranular
Grain Type: Biogenic, Calcilutite
85% Allochemical Constituents
Grain Size: Very Fine; Range: Fine to Medium
Poor Induration
Cement Type(s): Calcilutite Matrix
Accessory Minerals: Spar-25%
Other Features: Low Recrystallization
Fossils: Miliolids, Benthic Foraminifera, Cones
Medium Gray Dolostone 2%, Fine Limestone 5%, Miliolid
Forams 70% Dictyoconus americanus, D. Cookei, Nummulites
sp.
- 1607 - 1615 Limestone; Very Light Orange
20% Porosity: Intergranular
Grain Type: Biogenic, Calcilutite
85% Allochemical Constituents
Grain Size: Very Fine; Range: Fine to Medium
Poor Induration
Cement Type(s): Calcilutite Matrix
Accessory Minerals: Spar-10%
Other Features: Low Recrystallization
Fossils: Miliolids, Benthic Foraminifera, Cones
Miliolid Forams 80%, Dictyoconus americanus, D. Cookei
Medium Gray 3%.

- 1615 - 1660 Limestone; VERY LIGHT ORANGE
20% POROSITY: INTERGRANULAR
GRAIN TYPE: BIOGENIC, CALCILUTITE
85% ALLOCHEMICAL CONSTITUENTS
GRAIN SIZE: VERY FINE; RANGE: FINE TO MEDIUM
POOR INDURATION
CEMENT TYPE(S): CALCILUTITE MATRIX
ACCESSORY MINERALS: SPAR-10%
OTHER FEATURES: LOW RECRYSTALLIZATION
FOSSILS: MILIOLIDS, BENTHIC FORAMINIFERA, CONES
MILIOLID FORAMS 80%, DICTYOCONUS AMERICANUS, D. COOKEI.
- 1660 - 1745 Limestone; GRAYISH ORANGE PINK TO VERY LIGHT ORANGE
20% POROSITY: INTERGRANULAR
GRAIN TYPE: BIOGENIC, CALCILUTITE
85% ALLOCHEMICAL CONSTITUENTS
GRAIN SIZE: VERY FINE; RANGE: FINE TO MEDIUM
POOR INDURATION
CEMENT TYPE(S): CALCILUTITE MATRIX
ACCESSORY MINERALS: SPAR-20%, DOLOMITE-25%
OTHER FEATURES: LOW RECRYSTALLIZATION
FOSSILS: MILIOLIDS, BENTHIC FORAMINIFERA, CONES
MILIOLID FORAMS 80%, DICTYOCONUS COOKEI 1%, D. AMERICANUS
1%, FINE LIMESTONE 15%.
- 1745 - 1760 Limestone; GRAYISH ORANGE PINK
20% POROSITY: INTERGRANULAR
GRAIN TYPE: BIOGENIC, CALCILUTITE
75% ALLOCHEMICAL CONSTITUENTS
GRAIN SIZE: VERY FINE; RANGE: FINE TO MEDIUM
POOR INDURATION
CEMENT TYPE(S): CALCILUTITE MATRIX
ACCESSORY MINERALS: SPAR-10%, DOLOMITE-15%
OTHER FEATURES: LOW RECRYSTALLIZATION
FOSSILS: MILIOLIDS, BENTHIC FORAMINIFERA, CONES
5% MEDIUM GRAY DOLOSTONE, DICTYOCONUS AMERICANUS, MILIOLID
FORAMS 75%.
- 1760 - 1790 Limestone; VERY LIGHT ORANGE
20% POROSITY: INTERGRANULAR
GRAIN TYPE: BIOGENIC, CALCILUTITE
85% ALLOCHEMICAL CONSTITUENTS
GRAIN SIZE: VERY FINE; RANGE: FINE TO MEDIUM
POOR INDURATION
CEMENT TYPE(S): CALCILUTITE MATRIX
ACCESSORY MINERALS: SPAR-10%
OTHER FEATURES: LOW RECRYSTALLIZATION
FOSSILS: MILIOLIDS, BENTHIC FORAMINIFERA, CONES
MILIOLID FORAMS 80%, DICTYOCONUS AMERICANUS

- 1790 - 1814 LIMESTONE; VERY LIGHT ORANGE
 20% POROSITY: INTERGRANULAR
 GRAIN TYPE: BIOGENIC, CALCILUTITE
 85% ALLOCHEMICAL CONSTITUENTS
 GRAIN SIZE: VERY FINE; RANGE: FINE TO MEDIUM
 POOR INDURATION
 CEMENT TYPE(S): CALCILUTITE MATRIX
 ACCESSORY MINERALS: SPAR-10%
 OTHER FEATURES: LOW RECRYSTALLIZATION
 FOSSILS: MILIOLIDS, BENTHIC FORAMINIFERA, CONES
 LIGHT GRAY DOLOSTONE 1%, MILIOLID FORAMS 80%, DICTYOCONUS
 COOKEI, D. AMERICANUS.
- 1814 - 1820 LIMESTONE; VERY LIGHT ORANGE TO GRAYISH BROWN
 20% POROSITY: INTERGRANULAR
 GRAIN TYPE: BIOGENIC, CALCILUTITE
 85% ALLOCHEMICAL CONSTITUENTS
 GRAIN SIZE: VERY FINE; RANGE: FINE TO MEDIUM
 POOR INDURATION
 CEMENT TYPE(S): CALCILUTITE MATRIX
 ACCESSORY MINERALS: SPAR-30%
 OTHER FEATURES: LOW RECRYSTALLIZATION
 FOSSILS: MILIOLIDS, BENTHIC FORAMINIFERA, CONES
 DICTYOCONUS COOKEI 5%, MILIOLID FORAMS 75%, LITUONELLA
 FLORIDANA, D. AMERICANUS, PALE-YELLOWISH-BROWN SPARRY
 CALCITE 30%.
- 1820 - 1832 LIMESTONE; VERY LIGHT ORANGE
 20% POROSITY: INTERGRANULAR
 GRAIN TYPE: BIOGENIC, CALCILUTITE
 85% ALLOCHEMICAL CONSTITUENTS
 GRAIN SIZE: VERY FINE; RANGE: FINE TO MEDIUM
 POOR INDURATION
 CEMENT TYPE(S): CALCILUTITE MATRIX
 ACCESSORY MINERALS: SPAR-10%
 OTHER FEATURES: LOW RECRYSTALLIZATION
 FOSSILS: MILIOLIDS, BENTHIC FORAMINIFERA, CONES
 DICTYOCONUS COOKEI 3%, MILIOLID FORAMS 75%, D. AMERICANUS
 LIGHT- GRAY DOLOSTONE 1%.
- 1832 - 1833 DOLOSTONE; MODERATE LIGHT GRAY
 20% POROSITY: INTERGRANULAR; 50-90% ALTERED; SUBHEDRAL
 GRAIN SIZE: VERY FINE; RANGE: MICROCRYSTALLINE TO FINE
 MODERATE INDURATION
 CEMENT TYPE(S): DOLOMITE CEMENT
 SEDIMENTARY STRUCTURES: MASSIVE
 FOSSILS: NO FOSSILS

- 1833 - 1835 Limestone; VERY LIGHT ORANGE
20% POROSITY: INTERGRANULAR
GRAIN TYPE: BIOGENIC, CALCILUTITE
85% ALLOCHEMICAL CONSTITUENTS
GRAIN SIZE: VERY FINE; RANGE: FINE TO MEDIUM
POOR INDURATION
CEMENT TYPE(S): CALCILUTITE MATRIX
ACCESSORY MINERALS: SPAR-15%
OTHER FEATURES: LOW RECRYSTALLIZATION
FOSSILS: MILIOLIDS, BENTHIC FORAMINIFERA, CONES
MEDIUM-LIGHT GRAY DOLOSTONE 5%, MILIOLID FORAMS 80%
PHOSPHATE AS CAVINGS, DICTYOCONUS AMERICANUS, 5% FINE
LIMESTONE.
- 1835 - 1837 DOLOSTONE; MODERATE LIGHT GRAY
15% POROSITY: INTERCRYSTALLINE; 50-90% ALTERED; SUBHEDRAL
GRAIN SIZE: VERY FINE; RANGE: MICROCRYSTALLINE TO FINE
MODERATE INDURATION
CEMENT TYPE(S): DOLOMITE CEMENT
SEDIMENTARY STRUCTURES: MASSIVE
FOSSILS: NO FOSSILS
- 1837 - 1840 Limestone; VERY LIGHT ORANGE
20% POROSITY: INTERGRANULAR
GRAIN TYPE: BIOGENIC, CALCILUTITE
85% ALLOCHEMICAL CONSTITUENTS
GRAIN SIZE: VERY FINE; RANGE: MICROCRYSTALLINE TO FINE
POOR INDURATION
CEMENT TYPE(S): CALCILUTITE MATRIX
ACCESSORY MINERALS: DOLOMITE-40%, SPAR-10%
OTHER FEATURES: LOW RECRYSTALLIZATION
FOSSILS: MILIOLIDS
MEDIUM-LIGHT GRAY DOLOSTONE 40%, MILIOLID FORAMS 35%.
- 1840 - 1844 Limestone; VERY LIGHT ORANGE
20% POROSITY: INTERGRANULAR
GRAIN TYPE: BIOGENIC, CALCILUTITE
85% ALLOCHEMICAL CONSTITUENTS
GRAIN SIZE: VERY FINE; RANGE: MICROCRYSTALLINE TO FINE
POOR INDURATION
CEMENT TYPE(S): CALCILUTITE MATRIX
ACCESSORY MINERALS: SPAR-20%
OTHER FEATURES: LOW RECRYSTALLIZATION
FOSSILS: MILIOLIDS, BENTHIC FORAMINIFERA, CONES
MILIOLID FORAMS 80%, DICTYOCONUS AMERICANUS 2%, LITUONELLA
FLORIDANA, D. COOKEI.

- 1844 - 1846 DOLOSTONE; LIGHT GRAY
15% POROSITY: INTERCRYSTALLINE; 50-90% ALTERED; SUBHEDRAL
GRAIN SIZE: VERY FINE; RANGE: MICROCRYSTALLINE TO FINE
POOR INDURATION
CEMENT TYPE(S): CALCILUTITE MATRIX
ACCESSORY MINERALS: SPAR-10%, LIMESTONE-35%
OTHER FEATURES: LOW RECRYSTALLIZATION
FOSSILS: MILIOLIDS, BENTHIC FORAMINIFERA, CONES
NUMMULITES SP. DICTYOCONUS AMERICANUS 1%, MILIOLID FORAMS
35%, D. COCKEI.
- 1846 - 1856 LIMESTONE; VERY LIGHT ORANGE
20% POROSITY: INTERGRANULAR
GRAIN TYPE: BIOGENIC, CALCILUTITE
75% ALLOCHEMICAL CONSTITUENTS
GRAIN SIZE: VERY FINE; RANGE: MICROCRYSTALLINE TO FINE
POOR INDURATION
CEMENT TYPE(S): CALCILUTITE MATRIX
ACCESSORY MINERALS: SPAR-10%
OTHER FEATURES: LOW RECRYSTALLIZATION
FOSSILS: MILIOLIDS, BENTHIC FORAMINIFERA, CONES
DICTYOCONUS AMERICANUS 5%, D. COCKEI, MILIOLID FORAMS 80%.
- 1856 - 1859 DOLOSTONE; LIGHT GRAYISH BROWN
15% POROSITY: INTERCRYSTALLINE; 50-90% ALTERED; SUBHEDRAL
GRAIN SIZE: VERY FINE; RANGE: FINE TO MEDIUM
MODERATE INDURATION
CEMENT TYPE(S): DOLOMITE CEMENT
ACCESSORY MINERALS: LIMESTONE-20%, SPAR-05%
OTHER FEATURES: LOW RECRYSTALLIZATION
FOSSILS: MILIOLIDS, BENTHIC FORAMINIFERA, CONES
MILIOLID FORAMS 20%, DICTYOCONUS AMERICANUS.
- 1859 - 1885 LIMESTONE; VERY LIGHT ORANGE
20% POROSITY: INTERGRANULAR
GRAIN TYPE: BIOGENIC, CALCILUTITE
85% ALLOCHEMICAL CONSTITUENTS
GRAIN SIZE: VERY FINE; RANGE: MICROCRYSTALLINE TO FINE
POOR INDURATION
CEMENT TYPE(S): CALCILUTITE MATRIX
ACCESSORY MINERALS: SPAR-10%, CALCILUTITE-10%
OTHER FEATURES: LOW RECRYSTALLIZATION
FOSSILS: MILIOLIDS, BENTHIC FORAMINIFERA, CONES
MILIOLID FORAMS 80%, DICTYOCONUS AMERICANUS 5%
MEDIUM-LIGHT GRAY DOLOSTONE 5%.

- 1885 - 1960 Limestone; VERY LIGHT ORANGE
20% POROSITY: INTERGRANULAR
GRAIN TYPE: BIOGENIC, CALCILUTITE
85% ALLOCHEMICAL CONSTITUENTS
GRAIN SIZE: VERY FINE; RANGE: MICROCRYSTALLINE TO FINE
POOR INDURATION
CEMENT TYPE(S): CALCILUTITE MATRIX
ACCESSORY MINERALS: SPAR-10%
OTHER FEATURES: LOW RECRYSTALLIZATION
FOSSILS: MILIOLIDS, BENTHIC FORAMINIFERA, CONES
LIGHT-GRAY DOLOSTONE 5%, DICTYOCONUS AMERICANUS, MILIOLID
FORAMS 80%.
- 1960 - 1980 Limestone; VERY LIGHT ORANGE
20% POROSITY: INTERGRANULAR
GRAIN TYPE: BIOGENIC, CALCILUTITE
85% ALLOCHEMICAL CONSTITUENTS
GRAIN SIZE: VERY FINE; RANGE: MICROCRYSTALLINE TO FINE
POOR INDURATION
CEMENT TYPE(S): CALCILUTITE MATRIX
ACCESSORY MINERALS: SPAR-10%
OTHER FEATURES: LOW RECRYSTALLIZATION
FOSSILS: MILIOLIDS, BENTHIC FORAMINIFERA, CONES
DICTYOCONUS AMERICANUS 10%, MILIOLID FORAMS 80%.
- 1980 - 2005 Limestone; WHITE
20% POROSITY: INTERGRANULAR
GRAIN TYPE: BIOGENIC, CALCILUTITE
70% ALLOCHEMICAL CONSTITUENTS
GRAIN SIZE: VERY FINE; RANGE: MICROCRYSTALLINE TO FINE
POOR INDURATION
CEMENT TYPE(S): CALCILUTITE MATRIX
ACCESSORY MINERALS: CALCILUTITE-20%, SPAR-10%
OTHER FEATURES: LOW RECRYSTALLIZATION
FOSSILS: MILIOLIDS, BENTHIC FORAMINIFERA, CONES
FINE LIMESTONE 20%, MILIOLID FORAMS 60%, DICTYOCONUS
COOKEI, 5% LIGHT-GRAY DOLOSTONE.

- 2005 - 2010 Limestone; Very Light Orange
 20% Porosity: Intergranular
 Grain Type: Biogenic, Calcilutite
 85% Allochemical Constituents
 Grain Size: Fine; Range: Very Fine to Medium
 Poor Induration
 Cement Type(s): Calcilutite Matrix
 Accessory Minerals: Dolomite-20%, Spar-10%
 Other Features: Low Recrystallization
 Fossils: Miliolids, Benthic Foraminifera, Cones
 Pale Brown Dolostone 20%, Miliolid Forams 60%, Dictyoconus
 Cookei.
- 2010 - 2020 Limestone; Very Light Orange to Pinkish Gray
 20% Porosity: Intergranular
 Grain Type: Biogenic, Calcilutite
 85% Allochemical Constituents
 Grain Size: Fine; Range: Very Fine to Medium
 Poor Induration
 Cement Type(s): Calcilutite Matrix
 Accessory Minerals: Calcilutite-10%, Spar-10%
 Other Features: Low Recrystallization
 Fossils: Miliolids, Benthic Foraminifera, Cones
 Dictyoconus Cookei, Miliolid Forams 80%, Pale-Brown
 Dolostone 10%.
- 2020 - 2025 Limestone; White
 20% Porosity: Intergranular
 Grain Type: Biogenic, Calcilutite
 85% Allochemical Constituents
 Grain Size: Very Fine; Range: Microcrystalline to Fine
 Poor Induration
 Cement Type(s): Calcilutite Matrix
 Accessory Minerals: Calcilutite-10%, Spar-10%
 Other Features: Low Recrystallization
 Fossils: Miliolids
 Miliolid Forams 70%, Fine Limestone 20%.
- 2025 - 2030 Limestone; Grayish Orange Pink to Grayish Brown
 20% Porosity: Intergranular
 Grain Type: Biogenic, Calcilutite
 85% Allochemical Constituents
 Grain Size: Very Fine; Range: Microcrystalline to Fine
 Poor Induration
 Cement Type(s): Calcilutite Matrix
 Accessory Minerals: Calcilutite-10%, Spar-10%
 Other Features: Low Recrystallization
 Fossils: Miliolids
 50% Pale-Yellowish Brown Limestone, Miliolid Forams 80%.

- 2030 - 2035 Limestone; WHITE
20% POROSITY: INTERGRANULAR
GRAIN TYPE: BIOGENIC, CALCILUTITE
85% ALLOCHEMICAL CONSTITUENTS
GRAIN SIZE: VERY FINE; RANGE: MICROCRYSTALLINE TO FINE
POOR INDURATION
CEMENT TYPE(S): CALCILUTITE MATRIX
ACCESSORY MINERALS: CALCILUTITE-10%, SPAR-10%
OTHER FEATURES: LOW RECRYSTALLIZATION
FOSSILS: MILIOLIDS
MILIOLID FORAMS 35%, FINE LIMESTONE 50%.
- 2035 - 2050 Limestone; GRAYISH ORANGE PINK TO VERY LIGHT ORANGE
20% POROSITY: INTERGRANULAR
GRAIN TYPE: BIOGENIC, CALCILUTITE
85% ALLOCHEMICAL CONSTITUENTS
GRAIN SIZE: VERY FINE; RANGE: MICROCRYSTALLINE TO FINE
POOR INDURATION
CEMENT TYPE(S): CALCILUTITE MATRIX
ACCESSORY MINERALS: DOLOMITE-20%, SPAR-10%
CALCILUTITE-10%
OTHER FEATURES: LOW RECRYSTALLIZATION
FOSSILS: MILIOLIDS, BENTHIC FORAMINIFERA, CONES
DARK YELLOWISH-BROWN DOLOSTONE 20%, MILIOLID FORAMS 70%
DICTYOCONUS COOKEI, FINE LIMESTONE 10%.
- 2050 - 2057 Limestone; VERY LIGHT ORANGE
20% POROSITY: INTERGRANULAR
GRAIN TYPE: BIOGENIC, CALCILUTITE
75% ALLOCHEMICAL CONSTITUENTS
GRAIN SIZE: VERY FINE; RANGE: MICROCRYSTALLINE TO FINE
POOR INDURATION
CEMENT TYPE(S): CALCILUTITE MATRIX
ACCESSORY MINERALS: CALCILUTITE-10%, SPAR-10%
DOLOMITE-05%
OTHER FEATURES: LOW RECRYSTALLIZATION
FOSSILS: MILIOLIDS
MILIOLID FORAMS 60%, FINE LIMESTONE 20%, PALE-BROWN
DOLOSTONE 5%

- 2057 - 2080 DOLOSTONE; DARK YELLOWISH BROWN
10% POROSITY: INTERCRYSTALLINE; 90-100% ALTERED; EUHEDRAL
GRAIN SIZE: FINE; RANGE: VERY FINE TO MEDIUM
GOOD INDURATION
CEMENT TYPE(S): DOLOMITE CEMENT
ACCESSORY MINERALS: LIMESTONE-05%
OTHER FEATURES: HIGH RECRYSTALLIZATION
FOSSILS: NO FOSSILS
LIMESTONE IS MILIOLID FORAMS 5%.
- 2080 - 2083 DOLOSTONE; GRAYISH BROWN
25% POROSITY: INTERGRANULAR; 50-90% ALTERED; SUBHEDRAL
GRAIN SIZE: FINE; RANGE: VERY FINE TO MEDIUM
GOOD INDURATION
CEMENT TYPE(S): DOLOMITE CEMENT
OTHER FEATURES: HIGH RECRYSTALLIZATION
FOSSILS: NO FOSSILS
30% POROSITY IN 40% OF DOLOSTONE, REMAINDER IS FINE
GRAINED. BLACK LAYERS AND LAMINATIONS NOTED IN DOLOSTONE.
- 2083 - 2090 DOLOSTONE; VERY LIGHT ORANGE
10% POROSITY: INTERCRYSTALLINE; 50-90% ALTERED; SUBHEDRAL
GRAIN SIZE: FINE; RANGE: VERY FINE TO MEDIUM
GOOD INDURATION
CEMENT TYPE(S): DOLOMITE CEMENT
ACCESSORY MINERALS: CHERT-05%
OTHER FEATURES: HIGH RECRYSTALLIZATION
FOSSILS: NO FOSSILS
CHERT MAY BE SILICEOUS DOLOSTONE.
- 2090 - 2095 DOLOSTONE; LIGHT GRAYISH BROWN TO MODERATE GRAY
10% POROSITY: INTERCRYSTALLINE; 50-90% ALTERED; SUBHEDRAL
GRAIN SIZE: FINE; RANGE: VERY FINE TO MEDIUM
GOOD INDURATION
CEMENT TYPE(S): DOLOMITE CEMENT
OTHER FEATURES: HIGH RECRYSTALLIZATION
FOSSILS: NO FOSSILS
ALTERNATING BLACK AND DARK-YELLOWISH BROWN LAMINATIONS AND
LAYERS OF DOLOSTONE
- 2095 - 2120 DOLOSTONE; LIGHT GRAYISH BROWN
10% POROSITY: INTERCRYSTALLINE; 50-90% ALTERED; SUBHEDRAL
GRAIN SIZE: FINE; RANGE: VERY FINE TO MEDIUM
GOOD INDURATION
CEMENT TYPE(S): DOLOMITE CEMENT
OTHER FEATURES: HIGH RECRYSTALLIZATION
FOSSILS: NO FOSSILS

- 2120 - 2162 DOLOSTONE; DARK YELLOWISH BROWN
10% POROSITY: INTERCRYSTALLINE; 50-90% ALTERED; SUBHEDRAL
GRAIN SIZE: FINE; RANGE: VERY FINE TO MEDIUM
GOOD INDURATION
CEMENT TYPE(S): DOLOMITE CEMENT
ACCESSORY MINERALS: LIMESTONE-05%
OTHER FEATURES: HIGH RECRYSTALLIZATION
FOSSILS: NO FOSSILS
LIMESTONE IS MILIOLID FORAMS, DOLOSTONE IS MASIVE AND
RECRYSTALLIZED ~50-50 RATIO.
- 2162 - 2165 DOLOSTONE; MODERATE LIGHT GRAY
15% POROSITY: INTERCRYSTALLINE; 50-90% ALTERED; SUBHEDRAL
GRAIN SIZE: FINE; RANGE: VERY FINE TO MEDIUM
GOOD INDURATION
CEMENT TYPE(S): DOLOMITE CEMENT
ACCESSORY MINERALS: LIMESTONE-40%
OTHER FEATURES: HIGH RECRYSTALLIZATION
FOSSILS: MILIOLIDS, BENTHIC FORAMINIFERA, CONES
MEDIUM LIGHT-GRAY DOLOSTONE 60%, WHITE MILIOLID FORAMS 40%
DICTYOCONUS AMERICANUS, D. COOKEI.
- 2165 - 2170 DOLOSTONE; MODERATE YELLOWISH BROWN
15% POROSITY: INTERCRYSTALLINE; 50-90% ALTERED; SUBHEDRAL
GRAIN SIZE: FINE; RANGE: VERY FINE TO MEDIUM
GOOD INDURATION
CEMENT TYPE(S): DOLOMITE CEMENT
ACCESSORY MINERALS: LIMESTONE-10%
OTHER FEATURES: HIGH RECRYSTALLIZATION
FOSSILS: MILIOLIDS, BENTHIC FORAMINIFERA, CONES
DICTYOCONUS COOKEI, FABULARIA VAUGHANI (?).
- 2170 - 2175 DOLOSTONE; GRAYISH BROWN
20% POROSITY: INTERCRYSTALLINE; 50-90% ALTERED; SUBHEDRAL
GRAIN SIZE: FINE; RANGE: VERY FINE TO MEDIUM
GOOD INDURATION
CEMENT TYPE(S): DOLOMITE CEMENT
ACCESSORY MINERALS: LIMESTONE-30%
OTHER FEATURES: HIGH RECRYSTALLIZATION
FOSSILS: MILIOLIDS, BENTHIC FORAMINIFERA, CONES
MILIOLID FORAMS 30%, NUMMULITES SP., DICTYOCONUS COOKEI.

- 2175 - 2178 LIMESTONE; VERY LIGHT GRAY
20% POROSITY: INTERGRANULAR
GRAIN TYPE: BIOGENIC, CALCILUTITE
75% ALLOCHEMICAL CONSTITUENTS
GRAIN SIZE: VERY FINE; RANGE: MICROCRYSTALLINE TO FINE
POOR INDURATION
CEMENT TYPE(S): CALCILUTITE MATRIX
ACCESSORY MINERALS: DOLOMITE-20%, CALCILUTITE-20%
OTHER FEATURES: LOW RECRYSTALLIZATION
FOSSILS: MILIOLIDS
DOLOSTONE COATED WITH CALCILUTITE, MILIOLID FORAMS 40%.
- 2178 - 2192 DOLOSTONE; GRAYISH BROWN
15% POROSITY: INTERCRYSTALLINE; 50-90% ALTERED; SUBHEDRAL
GRAIN SIZE: FINE; RANGE: VERY FINE TO MEDIUM
GOOD INDURATION
CEMENT TYPE(S): DOLOMITE CEMENT
ACCESSORY MINERALS: LIMESTONE-30%
OTHER FEATURES: HIGH RECRYSTALLIZATION
FOSSILS: MILIOLIDS
FINE LIMESTONE 20%, MILIOLID FORAMS 10%.
- 2192 - 2210 LIMESTONE; VERY LIGHT ORANGE
20% POROSITY: INTERGRANULAR
GRAIN TYPE: BIOGENIC, CALCILUTITE
85% ALLOCHEMICAL CONSTITUENTS
GRAIN SIZE: VERY FINE; RANGE: MICROCRYSTALLINE TO FINE
POOR INDURATION
CEMENT TYPE(S): CALCILUTITE MATRIX
ACCESSORY MINERALS: DOLOMITE-15%
OTHER FEATURES: LOW RECRYSTALLIZATION
FOSSILS: MILIOLIDS, BENTHIC FORAMINIFERA, CONES
MILIOLID FORAMS 80%, DICTYOCONUS COOKEI.
- 2210 - 2225 DOLOSTONE; LIGHT GRAYISH BROWN
10% POROSITY: INTERCRYSTALLINE; 50-90% ALTERED; SUBHEDRAL
GRAIN SIZE: FINE; RANGE: VERY FINE TO MEDIUM
GOOD INDURATION
CEMENT TYPE(S): DOLOMITE CEMENT
ACCESSORY MINERALS: LIMESTONE-05%
OTHER FEATURES: HIGH RECRYSTALLIZATION
FOSSILS: MILIOLIDS
MILIOLID FORAMS 5%.

2225 - 2230 DOLOSTONE; GRAYISH BROWN TO MODERATE LIGHT GRAY
10% POROSITY: INTERCRYSTALLINE; 50-90% ALTERED; SUBHEDRAL
GRAIN SIZE: FINE; RANGE: VERY FINE TO MEDIUM
GOOD INDURATION
CEMENT TYPE(S): DOLOMITE CEMENT
ACCESSORY MINERALS: LIMESTONE-05%
OTHER FEATURES: HIGH RECRYSTALLIZATION
FOSSILS: MILIOLIDS

2230 - 2235 DOLOSTONE; GRAYISH BROWN
10% POROSITY: INTERCRYSTALLINE; 50-90% ALTERED; SUBHEDRAL
GRAIN SIZE: FINE; RANGE: VERY FINE TO MEDIUM
GOOD INDURATION
CEMENT TYPE(S): DOLOMITE CEMENT
ACCESSORY MINERALS: LIMESTONE-15%
OTHER FEATURES: HIGH RECRYSTALLIZATION
FOSSILS: MILIOLIDS
MILIOLID FORAMS 15% IN WHITE LIMESTONE.

2235 TOTAL DEPTH

APPENDIX C

PACKER TEST DRAWDOWN

AND RECOVERY DATA

Packer test drawdown and recovery data are provided in this appendix.

This page is intentionally left blank.

L-2 Canal Packer Test No.1-- Recovery Data
Test Interval: 2,075 to 2,124 feet below land surface

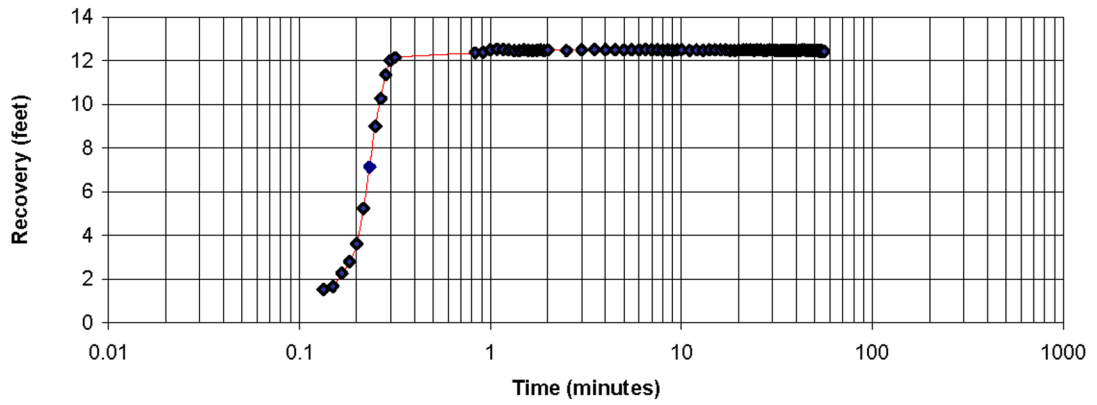

L-2 Canal Packer Test No. 2 -- Drawdown Data
Test Interval: 1,890 to 1,910 feet below land surface

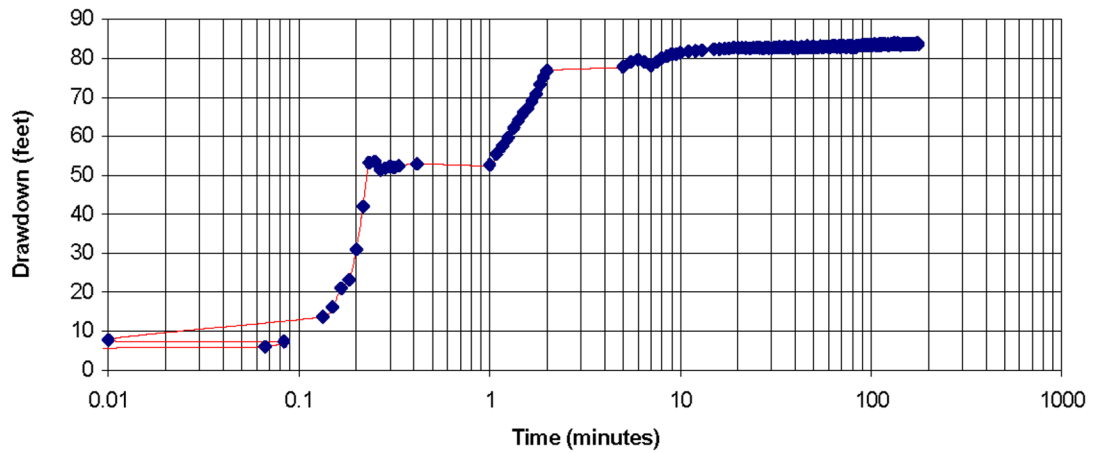

L-2 Canal Packer Test No. 2 -- Recovery Data
Test Interval: 1,890 to 1,910 feet below land surface

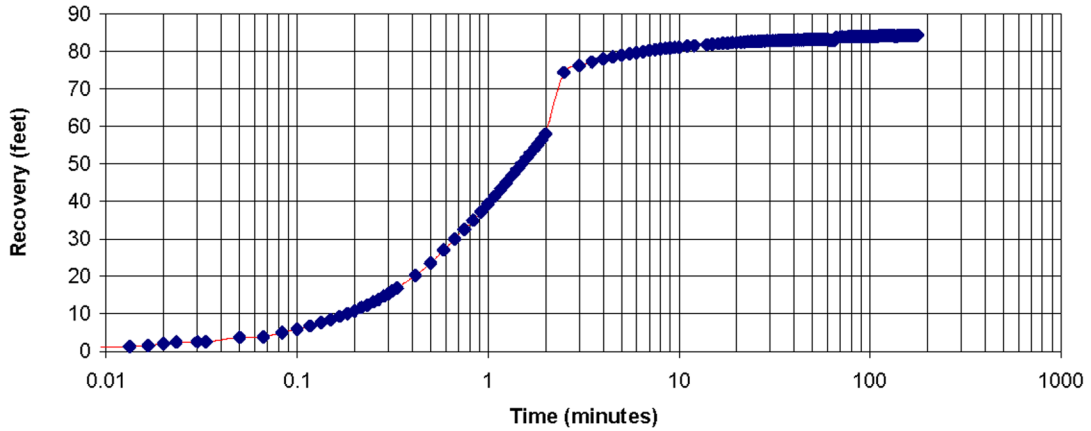

L-2 Canal Packer Test No. 3 -- Recovery Data
Test Interval: 1,266 to 1,286 feet below land surface

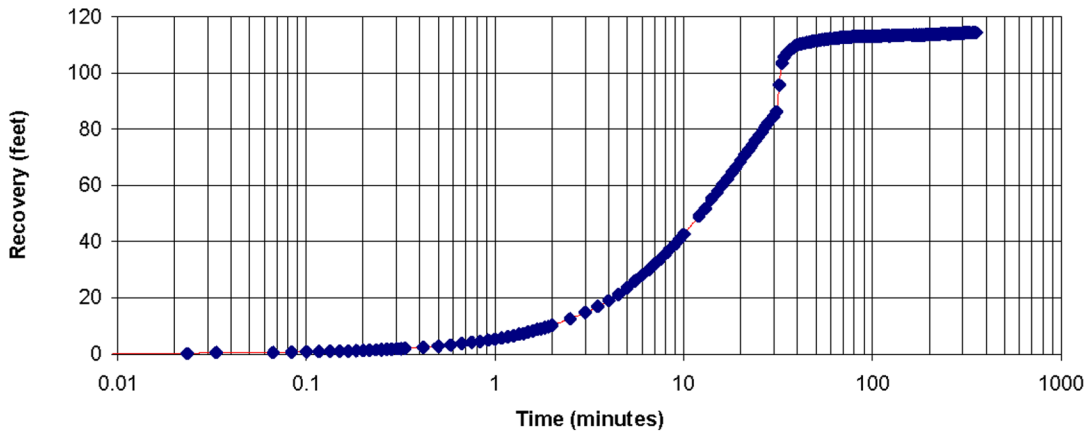

L-2 Canal Packer Test No. 4-- Drawdown Data
Test Interval: 1,652 to 1,704 feet below land surface

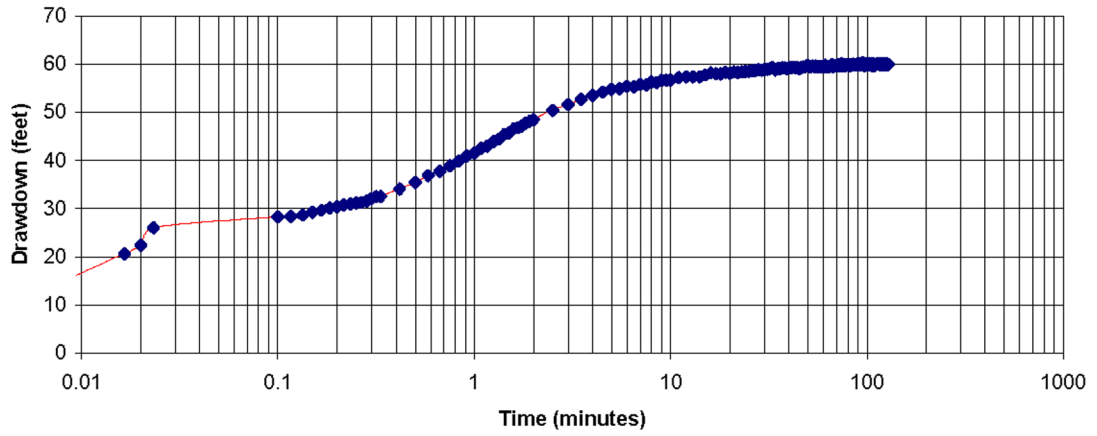

L-2 Canal Packer Test No. 5 – Drawdown Data
Test Interval: 1,442 to 1,492 feet below land surface

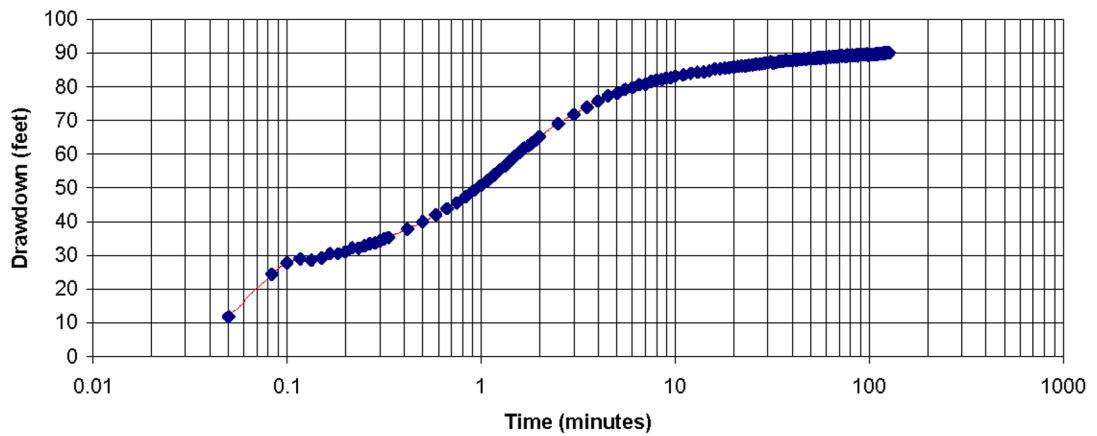

L-2 Canal Packer Test No. 5 -- Recovery Data
Test Interval: 1,442 to 1,492 feet below land surface

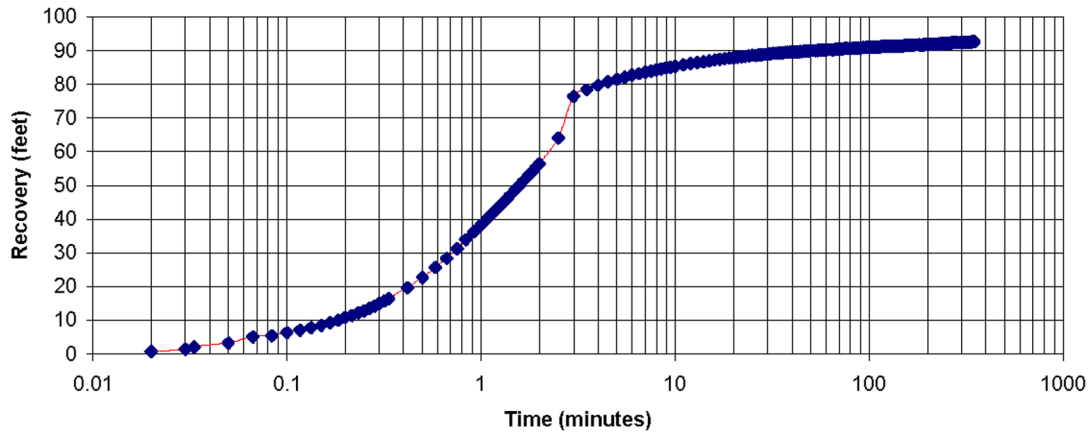

APPENDIX D

PETROPHYSICAL DATA

Core descriptions, summarizing the individual core intervals, are provided in this appendix. Petrophysical data follow the descriptions.

This page is intentionally left blank.

OCALA GROUP

Core Interval: 830.0 to 839.5 feet below land surface.

Description: Light gray to pale orange, very fine to coarse-grained, very poorly sorted, *Lepidocyclina* (sp) wackestone-packstone. Possess scattered vuggy and moldic porosity with minor intraparticle porosity. Scattered shelter porosity occurs at 832.4 ft bls. Grades downward into a fine to coarse grained skeletal-peloidal-wackestone containing large sponge spicules from 837.3 to 837.6 feet bls.

Depositional Environment: Open lagoon foram bank

Core Interval: 1,020.0 to 1,026.9 feet below land surface.

Description: A light yellowish gray colored, slightly laminated (1,020 to 1,021 feet bls), slightly dolomitic, foraminiferal-peloidal wackestone-packstone. Contains *Nummulites* (sp) (some sponge?) with scattered dolomite occlusions in *Nummulites* molds. *Nummulites* moldic porosity ranging from 3 to 15 mm in size. Abundant vuggy and interparticle porosity at 1,020 feet bls.

Depositional Environment: Open lagoon foram bank.

Core Interval: 1,026.9 to 1,029.8 feet below land surface.

Description: A light yellowish gray to pale orange colored, thinly laminated, moderately to well sorted, slightly dolomitic foraminiferal-peloidal packstone. Porosity is scattered in isolated vugs and is intercrystalline in nature. Abundant moldic micro-porosity occurs from 1,029 to 1,029.8 feet bls. This interval is also slightly dolomitic with 20% inter-crystalline porosity.

Depositional Environment: Restrictive lagoon

Core Interval: 1,190.0 to 1,190.7 feet below land surface.

Description: A grayish orange, poorly sorted, peloidal-intraclastic packstone occurs from 1,190 to 1,190.5 feet bls. A thinly laminated, wavy crystalline limestone continues from 1,190.5 to 1,190.9 feet bls. From 1,190.9 to 1,191.7 feet bls, a light orange to light brown, thinly laminated, microcrystalline to crystalline, interlaminated, very fine to fine-grained foraminiferal-peloidal packstone occurs possessing abundant microporosity.

Depositional Environment: Restrictive lagoon.

Core Interval: *1,191.7 to 1,194.1 feet below land surface.*

Description: Yellow gray to pale orange, very fine to fine grained, foram-peloidal wackestone-packstone with scattered vuggy porosity (2 to 5 mm in size) and minor intraparticle porosity. Possess very fine to fine sized vuggy molds and vertical vugs near the top, with microporosity at 1,193 feet bls. Partly recrystallized laminae, microfaults with offset laminae are present

Depositional Environment: Restrictive lagoon

Core Interval: *1,194.0 to 1,199.1 feet below land surface.*

Description: A light orange-yellow gray, laminated (wavy to slightly inclined), foram-peloidal-packstone. This interval is interlaminated with intraclastic algal peloidal boundstone laminae. Some of the laminae possess both vuggy and microporosity.

Depositional Environment: Restrictive lagoon/inter-tidal zone

Avon Park Formation

Core Interval: *1,330.0 to 1,331.6 feet below land surface.*

Description: A yellow gray very poorly sorted, fine grained peloidal-foram-intraclast packstone with 3 to 4 mm intraclasts. Fair vuggy and moldic porosity development with minor intraparticle porosity.

Depositional Environment: Restrictive shoal bank

Core Interval *1,331.6 to 1,332.0 feet below land surface.*

Description: A very light brown to very light orange colored, interlaminated (thin and inclined) foram-peloidal packstone.

Depositional Environment: Restrictive lagoon shoal

Core Interval: *1,332.0 to 1,334.3 feet below land surface.*

Description: A yellow gray, very fine to fine grained, moderately sorted, peloidal-foram packstone with good interparticle foram porosity, some large vertical vugs present at 1,332 feet bls.

Depositional Environment: Restrictive lagoon shoal

Core Interval: 1,334.3 to 1,336.3 feet below land surface.

Description: A yellow-gray to very pale orange, very fine to fine grained foram-peloidal-intraclastic packstone that is inter-laminated with fine grained laminae, very good interparticle porosity, minor vugs, and minor intraparticle porosity development.

Depositional Environment: Restrictive lagoon shoal

Core Interval: 1,336.3 to 1,339.0 feet below land surface.

Description: Dark yellowish brown to yellowish gray, very poorly sorted, foram-pellet packstone with intraclasts measuring 2 to 5 mm. Pellet intraclasts from 1,336.3 to 1,337.0 feet bls (rudstone). Some possible algal balls. Irregular laminated and patchy porosity with large secondary vugs, abundant microporosity at 1,337 feet bls. A pellet-intraclastic packstone-wackestone occurs at 1,338 feet bls with intercrystalline and vuggy porosity.

Depositional Environment: Restrictive lagoon shoal

Core Interval: 1,480.0 to 1,483.3 feet below land surface.

Description: Yellowish gray to very light brown to brown, moderately to well sorted, foram-peloidal packstone with good vuggy interparticle, and some secondary vugs. Intraparticle openings at 1,483 feet bls with 20% slightly cemented in vugs, trace of very fine crystalline dolomite rim cement.

Depositional Environment: Restrictive lagoon shoal

Core Interval: 1,483.3 to 1,485.0 feet below land surface.

Description: Yellowish gray to light gray, foram-intraclast-pellet packstone-rudstone, fair to good vuggy interparticle porosity, some microporosity at 1,483.7 feet bls, 5% quartz with undulatory extinction, slight recrystallization.

Depositional Environment: Restrictive lagoon shoal

Core Interval: 1,580.0 to 1,583.3 feet below land surface.

Description: Yellowish gray to very light gray, sponge-foram-pellet packstone, slightly laminated, slightly glauconitic, with good vuggy interparticle and fair foram intraparticle porosity with scattered secondary vugs. A few thin interbeds are present that contains good vuggy moldic porosity and secondary calcite cement in intraparticle pores with possible traces of dolomite rim cement.

Depositional Environment: Restrictive lagoon shoal

Core Interval: 1,630.0 to 1631.6 feet below land surface.

Description: Light gray to light orange, very fine to coarse grained, moderately sorted, foram-peloidal wackestone-packstone that is slightly laminated. Fair moldic porosity development with scattered vugs .1 to .25 mm in size, scattered foram intraparticle porosity with traces of very fine crystalline dolomite rim cement in pore.

Depositional Environment: Restrictive lagoon shoal flank

Core Interval: 1,631.6 to 1,633.3 feet below land surface.

Description: Orange-gray, nonlaminated, partially recrystallized, very fine to fine grained, foram-peloidal wackestone with abundant microporosity and fair amount of scattered vuggy moldic porosity. Traces of very fine crystalline rim cement in pores.

Depositional Environment: Restrictive lagoon

Core Interval: 1,710.0 to 1,711.0 feet below land surface.

Description: Light brown to yellowish gray, foram-peloidal wackestone with patches of vuggy interparticle porosity, moldic vuggy porosity, and microporosity. This interval is slightly laminated with a few vertical vugs and a trace of very fine crystalline rim dolomite cement in molds.

Depositional Environment: Restrictive lagoon

Core Interval: 1,711.0 to 1,711.3 feet below land surface.

Description: Light grayish brown, very fine to coarse grained, poorly sorted foram-peloidal-intraclastic wackestone with scattered vuggy moldic porosity and a few diagonal vugs ranging 5 to 45 mm in size.

Depositional Environment: Restrictive lagoon shoal flank.

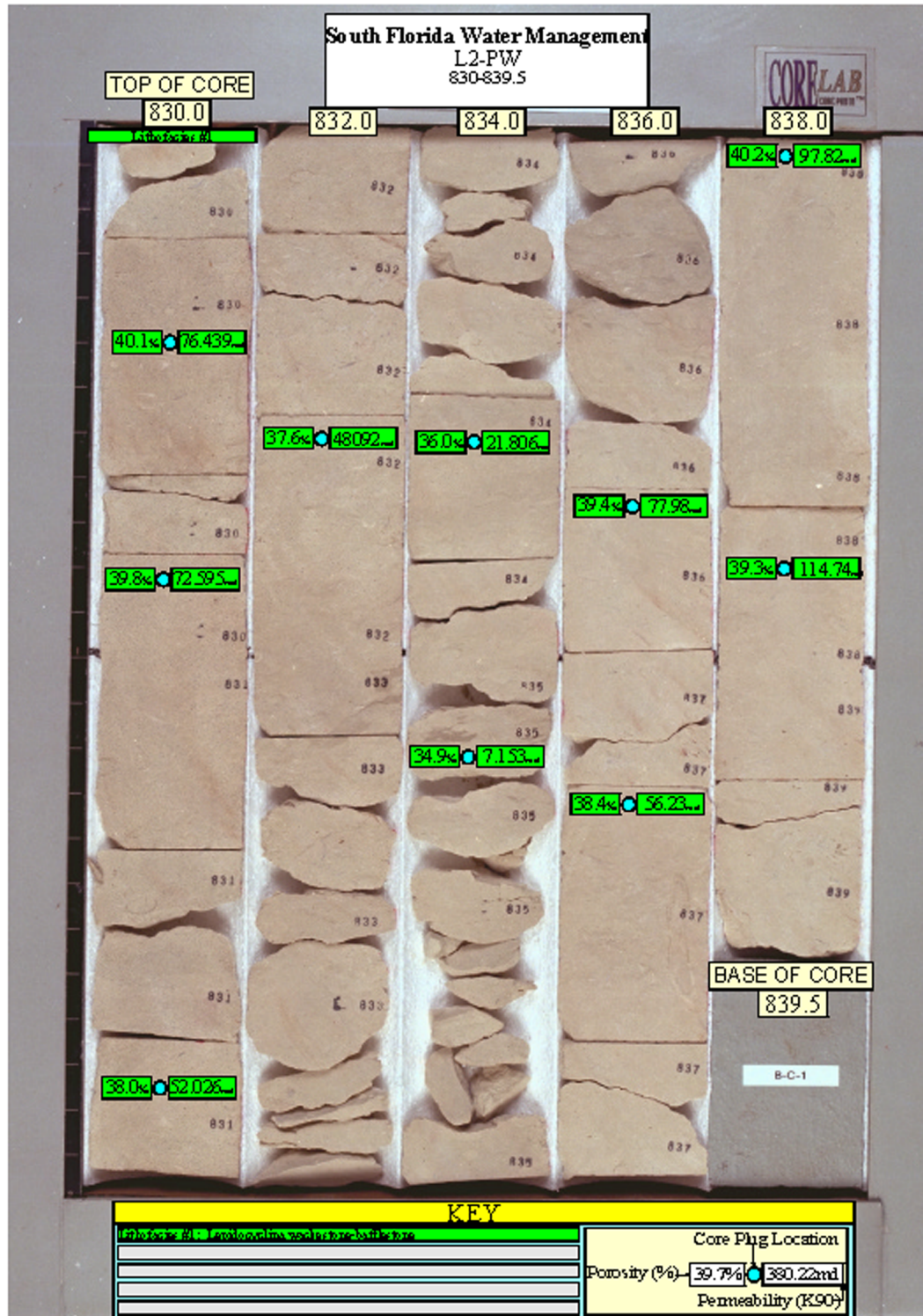

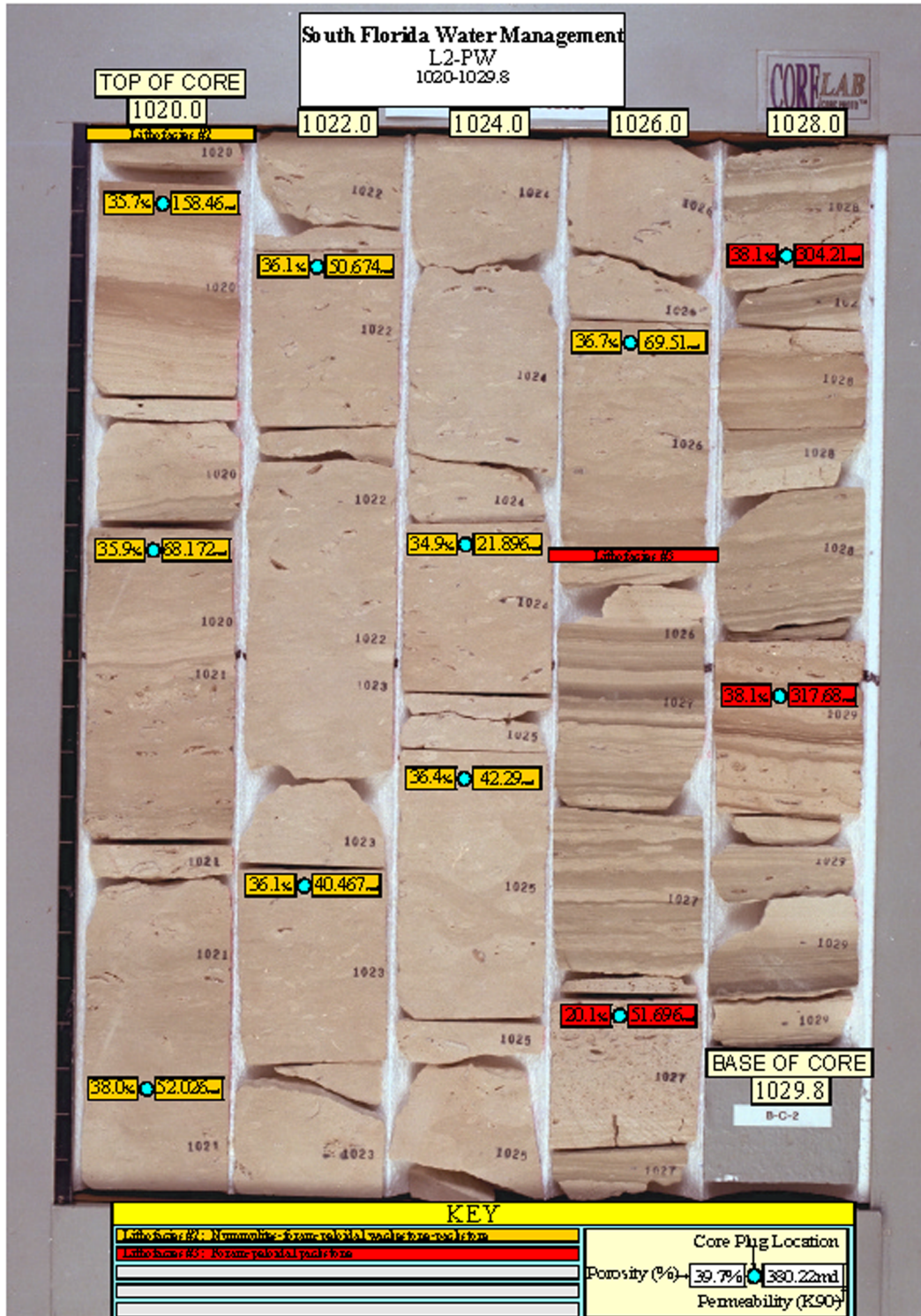



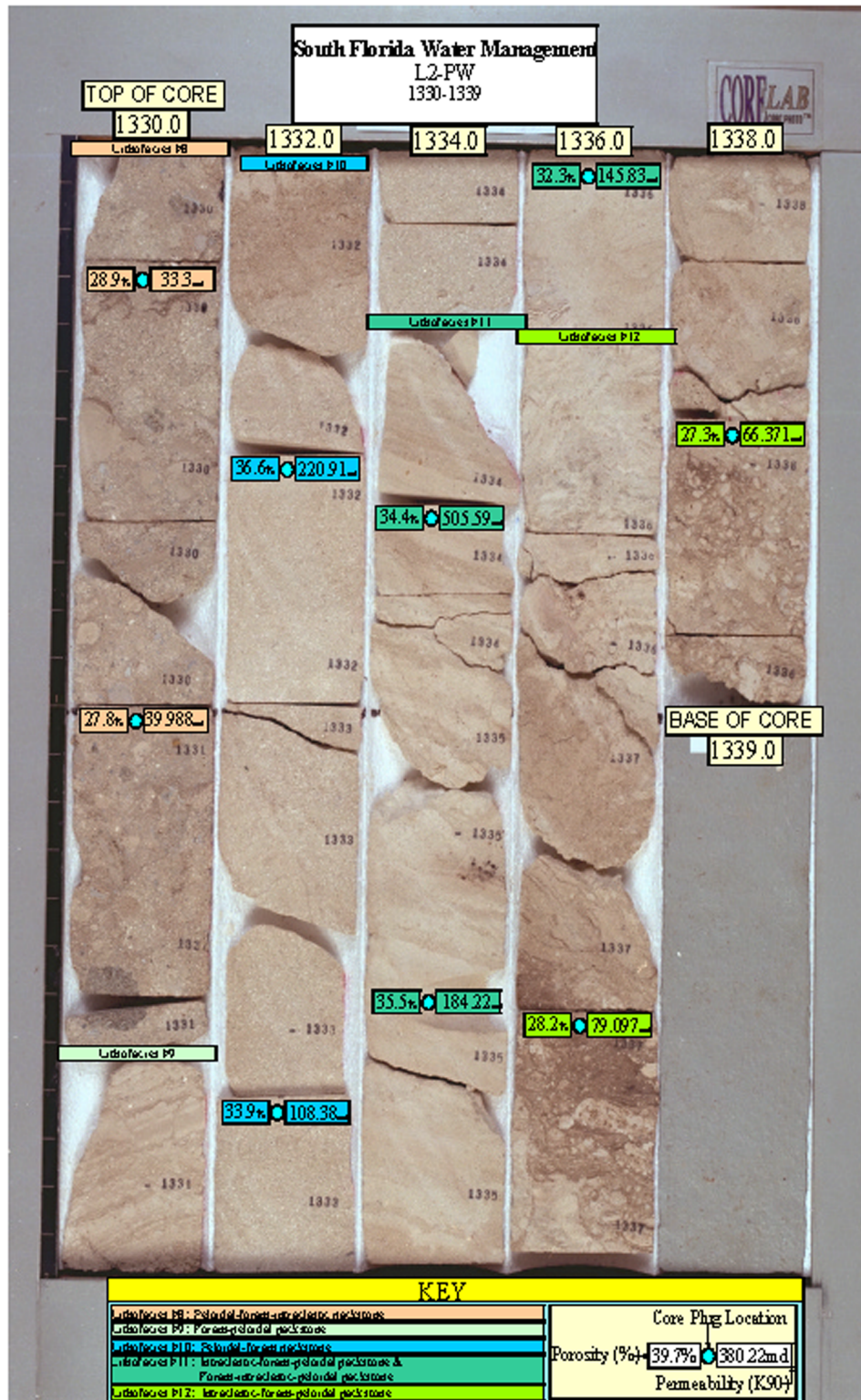

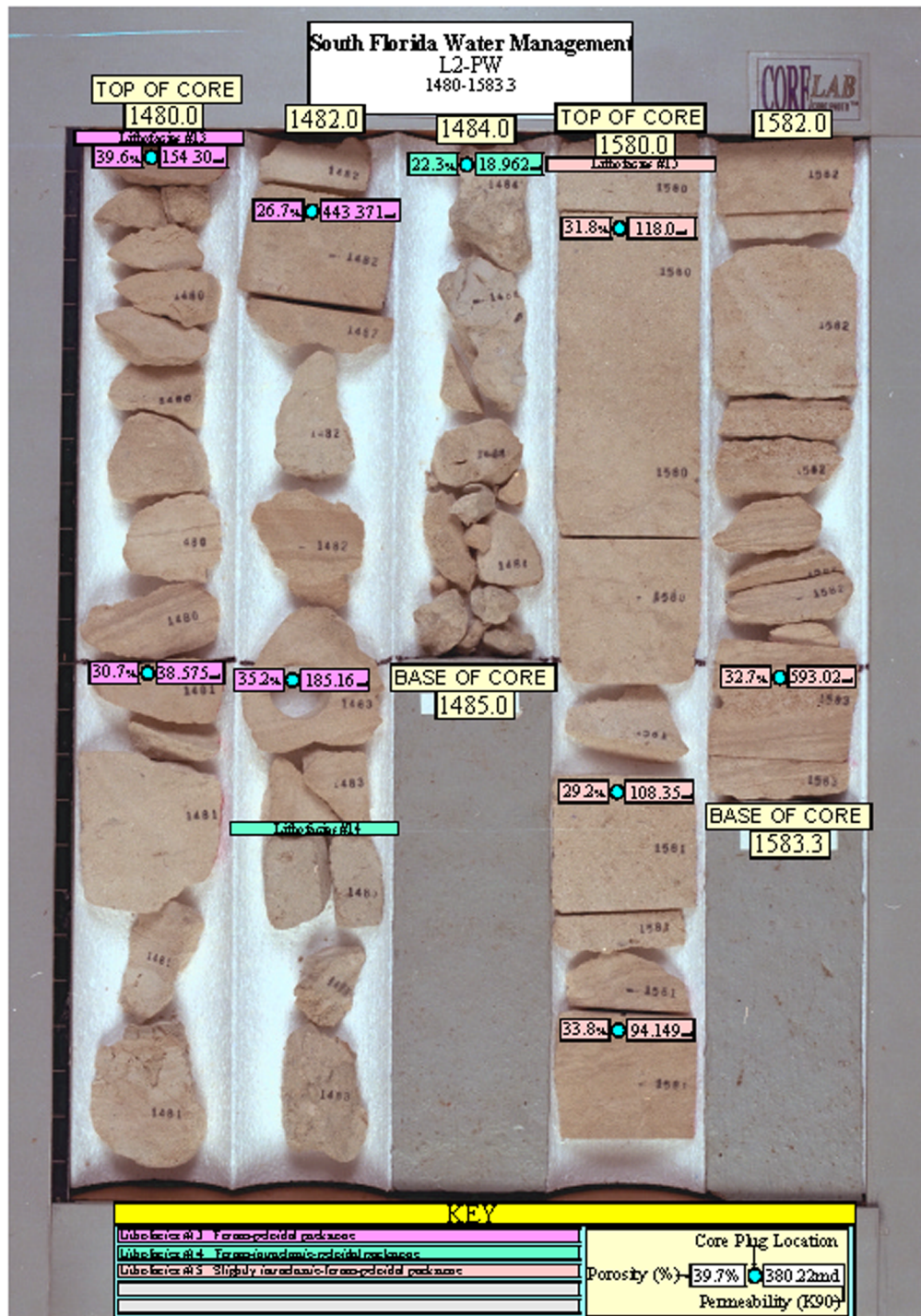



Table D-1. Core Analysis Results for L-2 Canal Drill Site, Hendry County, Florida

Core #	Sample #	Depth (ft bls)	Horizontal Permeability (Kair-md)	Vertical Permeability (Kair-md)	Vertical/Horizontal Ratio	Porosity Helium (%)	Grain Density (g/cm ³)	Description
1	1	830.4	76.40	65.4	0.856	40.1	2.67	Lim, pp
	2	831.2	72.56	67.0	0.923	39.8	2.66	Lim, pp
	3	832.0	52.03	43.3	0.832	38.0	2.64	Lim, pp, foss
	4	833.4	48.09	29.1	0.605	37.6	2.63	Lim, pp
	5	834.8	21.81	10.9	0.500	36.0	2.64	Lim, pp
	6	835.2	7.15			34.9	2.67	Lim, pp
	7	836.9	77.98	55.7	0.714	39.4	2.67	Lim, pp
	8	837.5	56.23	46.0	0.818	38.4	2.70	Lim, pp
	9	838.4	97.82	91.6	0.936	40.2	2.68	Lim, pp
	10	839.9	114.74	89.1	0.777	39.3	2.66	Lim, pp
Average:			62.5	55.3	0.774	38.4	2.66	
Standard Deviation:			32.6	26.4	0.145	1.8	0.02	
2	11	1020.3	158.46	9.8	0.062	35.7	2.68	Ls, pp, lam
	12	1021.1	68.20	20.3	0.298	35.9	2.70	Lim, sl vug, foss
	13	1022.5	50.67	34.6	0.683	36.1	2.69	Lim, sl vug, foss
	14	1023.5	40.47	23.4	0.578	36.1	2.66	Lim, sl vug, foss
	15	1024.9	21.90	13.6	0.621	34.9	2.67	Lim, sl vug, foss
	16	1025.5	42.29	28.8	0.681	36.4	2.69	Lim, sl vug, foss
	17	1026.6	69.51	29.5	0.424	36.7	2.66	Lim, sl vug, foss
	18	1027.8	51.70	1.6	0.031	20.1	2.71	Lim, sl vug, foss
	19	1028.4	304.21	21.4	0.070	38.1	2.67	Lim, sl vug, foss
	20	1029.2	317.68	9.7	0.031	38.1	2.64	Lim, sl vug, foss
Average:			112.5	19.3	0.348	34.8	2.68	
Standard Deviation:			110.9	10.4	0.283	5.3	0.02	
3	21	1190.3	23.65	16.8	0.710	32.1	2.76	Lim, sl vug, foss
	22	1191.2	70.55	1.5	0.021	41.3	2.78	Lim, sl vug, foss
	23	1192.2	63.67	39.0	0.612	38.7	2.67	Lim, sl vug, foss
	24	1192.9	21.84	13.8	0.632	37.2	2.67	Lim, sl vug, foss
	25	1195.0	37.90	17.6	0.464	37.2	2.69	Lim, pp
	26	1195.8	72.30	3.3	0.046	38.7	2.70	Lim, pp
	27	1196.5	65.01	42.2	0.649	43.5	2.75	Lim, pp
	28	1196.0	169.42	51.6	0.305	42.5	2.74	Lim, pp, lam
	29	1197.0	106.27	12.6	0.119	42.9	2.74	Lim, pp, lam
ft bls - feet below land surface		Lim - Limestone		lam - laminated				
g/cm ³ - grams per cubic centimeter		pp - pin-point porosity		sl vug - slightly vuggy				
md - millidarcies		foss - fossils						

Table D-1. Core Analysis Results for L-2 Canal Drill Site, Hendry County, Florida (Continued)

Core #	Sample #	Depth (ft bls)	Horizontal Permeability (Kair-md)	Vertical Permeability (Kair-md)	Vertical/ Horizon Ratio	Porosity Helium (%)	Grain Density (g/cm ³)	Description
Average:			70.1	22.0	0.395	39.3	2.72	
Standard Deviation:			45.8	17.8	0.278	3.6	0.04	
4	30	1330.5	33.30	19.3	0.580	28.9	2.76	Lim, pp
	31	1331.3	39.99	28.0	0.700	27.8	2.78	Lim, pp
	32	1332.8	220.91	190.0	0.860	36.6	2.67	Lim, pp
	33	1333.8	108.38	86.8	0.801	33.9	2.67	Lim, pp
	34	1334.8	505.59	165.0	0.326	34.4	2.69	Lim, pp
	35	1335.8	184.22			35.5	2.70	Lim, pp
	36	1336.4	145.83	85.2	0.584	32.3	2.75	Lim, sl vug
	37	1337.8	79.10	47.3	0.598	28.2	2.74	Lim, sl vug
	38	1338.6	66.37	55.6	0.838	27.3	2.72	Lim, sl vug
Average:			153.7	84.7	0.661	31.7	2.72	
Standard Deviation:			146.6	62.4	0.177	3.6	0.04	
5	39	1480.5	154.30			39.6	2.70	Lim, pp
	40	1481.5	38.58			30.7	2.70	Lim, pp
	41	1482.5	443.37	310.0	0.699	26.7	2.71	Lim, pp
	42	1483.5	185.16			35.2	2.70	Lim, pp
	43	1484.5	18.96			22.3	2.74	Lim, pp
Average:			168.1			30.9	2.71	
Standard Deviation:			169.8			6.8	0.02	
6	44	1580.4	118.00	112.0	0.949	31.8	2.70	Lim, pp
	45	1581.4	108.35	83.6	0.772	29.2	2.70	Lim, pp
	46	1581.9	94.15	66.0	0.701	33.8	2.68	Lim, pp
	47	1583.2	593.02	75.5	0.127	32.7	2.71	Lim, pp
Average:			228.4	84.3	0.637	31.9	2.70	
Standard Deviation:			243.3	19.8	0.356	2.0	0.01	
7	48	1630.7	51.90	26.5	0.511	32.0	2.68	Lim, sl vug
	49	1631.2	226.00	43.2	0.191	30.3	2.69	Lim, pp
	50	1632.5	202.00			33.8	2.71	Lim, pp
Average:			160.0	34.9	0.351	32.0	2.69	
Standard Deviation:			94.4			1.8	0.02	
8	51	1710.3	115.00	45.3	0.394	34.3	2.69	Lim,pp
	52	1710.8	129.96			34.6	2.71	Lim, sl vug
Average:			122.5			34.5	2.70	
Standard Deviation:			10.6			0.2	0.0	
ft bls - feet below land surface		Lim - Limestone	lam - laminated					
g/cm ³ - grams per cubic centimeter		pp - pin-point porosity	sl vug - slightly vuggy					
md - millidarcies		foss - fossils						

APPENDIX E

PETROLOGIC DATA: PHOTOMICROGRAPHS

This appendix provides a petrologic summary for each core section, generated by Collier Consulting Inc. of Stephenville, Texas, as listed in **Table E-1**. Photomicrographs, illustrating petrologic data, are shown.

This page is intentionally left blank.

Table E-1. Summary of Petrologic Analyses

Core No.	Sample No.	Depth (ft (bls))	Lithofacies	Depositional Environment	Horiz Perm Kair-md	Vert. Perm. Kair-md	Vert/ Horiz. Ratio	Porosity Helium (%)	Grain Density (g/cm ³)
1	1H/V	830.4	Lepidocyclina-wackestone-bafflestone	Open Lagoon Foram Bank	76.40	65.4	0.856	40.1	2.67
	2H/V	831.2	Lepidocyclina-wackestone-bafflestone	Open Lagoon Foram Bank	72.56	67.0	0.923	39.8	2.66
	3H/V	832.0	Lepidocyclina-wackestone-bafflestone	Open Lagoon Foram Bank	52.03	43.3	0.832	38.0	2.64
	4H/V	833.4	Lepidocyclina-wackestone-bafflestone	Open Lagoon Foram Bank	48.09	29.1	0.605	37.6	2.63
	5H/V	834.8	Lepidocyclina-wackestone-bafflestone	Open Lagoon Foram Bank	21.81	10.9	0.500	36.0	2.64
	6H	835.2	Lepidocyclina-wackestone-bafflestone	Open Lagoon Foram Bank	7.15			34.9	2.67
	7H/V	836.9	Lepidocyclina-wackestone-bafflestone	Open Lagoon Foram Bank	77.98	55.7	0.714	39.4	2.67
	8H/V	837.5	Lepidocyclina-wackestone-bafflestone	Open Lagoon Foram Bank	56.23	46.0	0.818	38.4	2.70
	9H/V	838.4	Lepidocyclina-wackestone-bafflestone	Open Lagoon Foram Bank	97.82	91.6	0.936	40.2	2.68
	10H/V	839.9	Lepidocyclina-wackestone-bafflestone	Open Lagoon Foram Bank	114.74	89.1	0.777	39.3	2.66
				Mean	62.48	55.3	0.774	38.4	2.66
				Median	64.40	55.70	0.82	38.85	2.67

Table E-1. Summary of Petrologic Analyses (Continued)

Core No.	Sample No.	Depth (ft (bls))	Lithofacies	Depositional Environment	Horiz Perm Kair-md	Vert. Perm. Kair-md	Vert/ Horiz. Ratio	Porosity Helium (%)	Grain Density (g/cm ³)
2	11H-V	1020.3	Foram-peloidal wackestone-packstone	Open Lagoon Forum Bank	158.46	9.8	0.062	35.7	2.68
	12H-V	1021.1	Foram-peloidal wackestone-packstone	Open Lagoon Forum Bank	68.20	20.3	0.298	35.9	2.70
	13H-V	1022.5	Foram-peloidal wackestone-packstone	Open Lagoon Forum Bank	50.67	34.6	0.683	36.1	2.69
	14H-V	1023.5	Foram-peloidal wackestone-packstone	Open Lagoon Forum Bank	40.47	23.4	0.578	36.1	2.66
	15H-V	1024.9	Foram-peloidal wackestone-packstone	Open Lagoon Forum Bank	21.90	13.6	0.621	34.9	2.67
	16H-V	1025.5	Foram-peloidal wackestone-packstone	Open Lagoon Forum Bank	42.29	28.8	0.681	36.4	2.69
	17H-V	1026.6	Foram-peloidal wackestone-packstone	Open Lagoon Forum Bank	69.51	29.5	0.424	36.7	2.66
				Mean	64.50	22.86	0.48	35.97	2.68
				Median	50.67	23.40	0.58	36.10	2.68
	18H-V	1027.8	Foram-peloidal packstone	Restrictive Lagoon	51.70	1.6	0.031	20.1	2.71
	19H-V	1028.4	Foram-peloidal packstone	Restrictive Lagoon	304.21	21.4	0.070	38.1	2.67
	20H-V	1029.2	Foram-peloidal packstone	Restrictive Lagoon	317.68	9.7	0.031	38.1	2.64
				Mean	224.53	10.90	0.04	32.10	2.67
				Median	304.21	9.70	0.03	38.10	2.67

Table E-1. Summary of Petrologic Analyses (Continued)

Core No.	Sample No.	Depth (ft (bls))	Lithofacies	Depositional Environment	Horiz Perm Kair-md	Vert. Perm. Kair-md	Vert/ Horiz. Ratio	Porosity Helium (%)	Grain Density (g/cm ³)
3	21H-V	1190.3	Peloidal-interclastic packstone	Restrictive Lagoon	23.65	16.8	0.710	32.1	2.76
	22H-V	1191.2	Foram-peloidal packstone	Restrictive Lagoon	70.55	1.5	0.021	41.3	2.78
	23H-V	1192.2	Foram-peloidal wackestone-packstone	Restrictive Lagoon	63.67	39.0	0.613	38.7	2.67
	24H-V	1192.9	Foram-peloidal wackestone-packstone	Restrictive Lagoon	21.84	13.8	0.632	37.2	2.67
	25H-V	1195.0	Foram-peloidal wackestone-packstone	Restrictive Lagoon	37.90	17.6	0.464	37.2	2.69
	26H-V	1195.8	Foram-peloidal wackestone-packstone	Restrictive Lagoon	72.30	3.3	0.046	38.7	2.70
				Mean	48.32	15.33	0.41	37.53	2.71
				Median	50.79	15.30	0.54	37.95	2.70
	27H-V	1196.5	Foram-peloidal packstone w/ algal lam.	Restrictive Lagoon-Intertidal	65.01	42.2	0.649	43.5	2.75
	28H-V	1196.0	Foram-peloidal packstone w/ algal lam.	Restrictive Lagoon-Intertidal	169.42	51.6	0.305	42.5	2.74
	29H-V	1197.0	Foram-peloidal packstone w/ algal lam.	Restrictive Lagoon-Intertidal	106.27	12.6	0.119	42.9	2.74
				Mean	113.57	35.47	0.36	42.97	2.74
				Median	106.27	42.20	0.30	42.90	2.74
4	30H-V	1330.5	Peloidal-foram-interclastic packstone	Restrictive Shoal Bank	33.30	19.3	0.580	28.9	2.76
	31H-V	1331.3	Peloidal-foram-interclastic packstone	Restrictive Shoal Bank	39.99	28.0	0.700	27.8	2.78
				Mean	36.65	23.65	0.64	28.35	2.77
				Median	36.65	23.65	0.64	28.35	2.77
	32H-V	1332.8	Peloidal-foram packstone	Restrictive Lagoon Shoal	220.91	190.0	0.860	36.6	2.67

Table E-1. Summary of Petrologic Analyses (Continued)

Core No.	Sample No.	Depth feet (bls)	Lithofacies	Depositional Environment	Horiz Perm Kair-md	Vert. Perm. Kair-md	Vert/ Horiz. Ratio	Porosity Helium (%)	Grain Density (g/cm ³)
4	33H-V	1333.8	Peloidal-foram packstone	Restrictive Lagoon Shoal	108.38	86.8	0.801	33.9	2.67
	34H-V	1334.8	Foram-interclastic-peloidal packstone	Restrictive Lagoon Shoal	505.59	165.0	0.326	34.4	2.69
	35H	1335.8	Foram-interclastic-peloidal packstone	Restrictive Lagoon Shoal	184.22			35.5	2.70
	36H-V	1336.4	Foram-interclastic-peloidal packstone	Restrictive Lagoon Shoal	145.83	85.2	0.584	32.3	2.75
	37H-V	1337.8	Intraclastic-foram-peloidal packstone	Restrictive Lagoon Shoal	79.10	47.3	0.598	28.2	2.74
	38H-V	1338.6	Intraclastic-foram-peloidal packstone	Restrictive Lagoon Shoal	66.37	55.6	0.838	27.3	2.72
				Mean	187.20	104.98	0.67	32.60	2.71
			Median	145.83	86.00	0.70	33.90	2.70	
5	39H	1480.5	Foram-peloidal packstone	Restrictive Lagoon Shoal	154.30			39.6	2.70
	40H	1481.5	Foram-peloidal packstone	Restrictive Lagoon Shoal	38.58			30.7	2.70
	41H-V	1482.5	Foram-peloidal packstone	Restrictive Lagoon Shoal	443.37	310.0	0.699	26.7	2.71
	42H	1483.5	Foram-peloidal packstone	Restrictive Lagoon Shoal	185.16			35.2	2.70
	43H	1484.5	Foram-intraclastic-peloidal packstone	Restrictive Lagoon Shoal	18.96			22.3	2.74
				Mean	168.07			30.90	2.71
			Median	154.30			30.70	2.70	
6	44H-V	1580.4	Intraclastic-foram-peloidal packstone	Restrictive Lagoon Shoal	118.00	112.0	0.949	31.8	2.70
	45H-V	1581.4	Intraclastic-foram-peloidal packstone	Restrictive Lagoon Shoal	108.35	83.6	0.772	29.2	2.70
	46H-V	1581.9	Intraclastic-foram-peloidal packstone	Restrictive Lagoon Shoal	94.15	66.0	0.701	33.8	2.68

Table E-1. Summary of Petrologic Analyses (Continued)

Core No.	Sample No.	Depth feet (bls)	Lithofacies	Depositional Environment	Horiz Perm Kair-md	Vert. Perm. Kair-md	Vert/ Horiz. Ratio	Porosity Helium (%)	Grain Density (g/cm ³)
6	47H-V	1583.2	Intraclastic-foram-peloidal packstone	Restrictive Lagoon Shoal	593.02	75.5	0.127	32.7	2.71
				Mean	228.38	84.28	0.64	31.88	2.70
				Median	113.18	79.55	0.74	32.25	2.70
7	48H-V	1630.7	Foram-peloidal wackestone-packstone	Restrictive Lagoon Shoal Fl	51.90	26.5	0.511	32.0	2.68
	49H-V	1631.2	Foram-peloidal wackestone	Restrictive Lagoon	226.00	43.2	0.191	30.3	2.69
	50H	1632.5	Foram-peloidal wackestone	Restrictive Lagoon	202.00			33.8	2.71
				Mean	159.97	34.85	0.35	32.03	2.69
				Median	202.00	34.85	0.35	32.00	2.69
8	51H-V	1710.3	Foram-peloidal wackestone	Restrictive Lagoon	115.00	45.3	0.394	34.3	2.69
	52H *	1710.8	Foram-peloidal wackestone	Restrictive Lagoon	129.96			34.6	2.71
				Mean	122.48			34.45	2.70
				Median	122.48			34.45	2.70

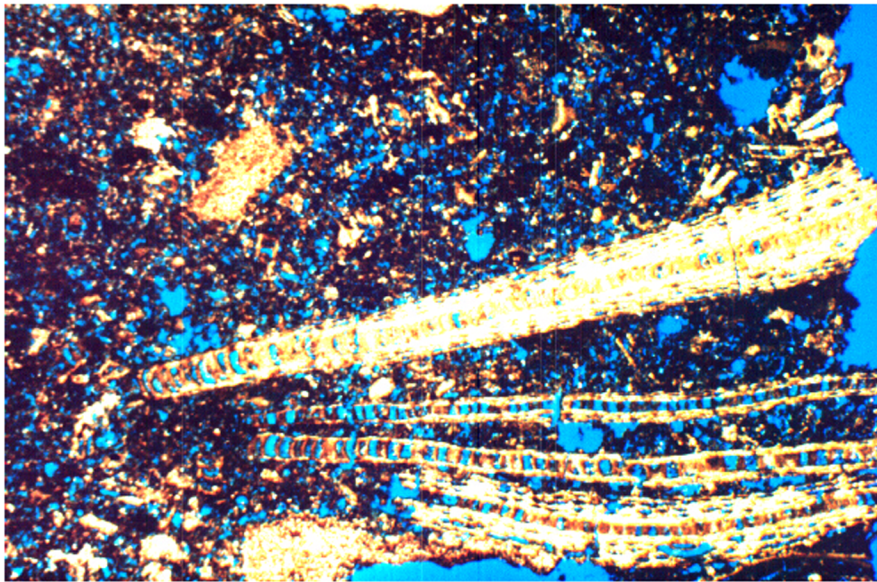

WELL: L2-PW
DEPTH: 836.9
MAGNIFICATION: X20

LITHOFACIES: LEPIDOCYCLINA PELOIDAL WACKESTONE-BAFFLESTONE
WITH FAIR VUGGY MOLDIC AND TRACES OF SHELTER AND INTRAPARTICLE
POROSITY

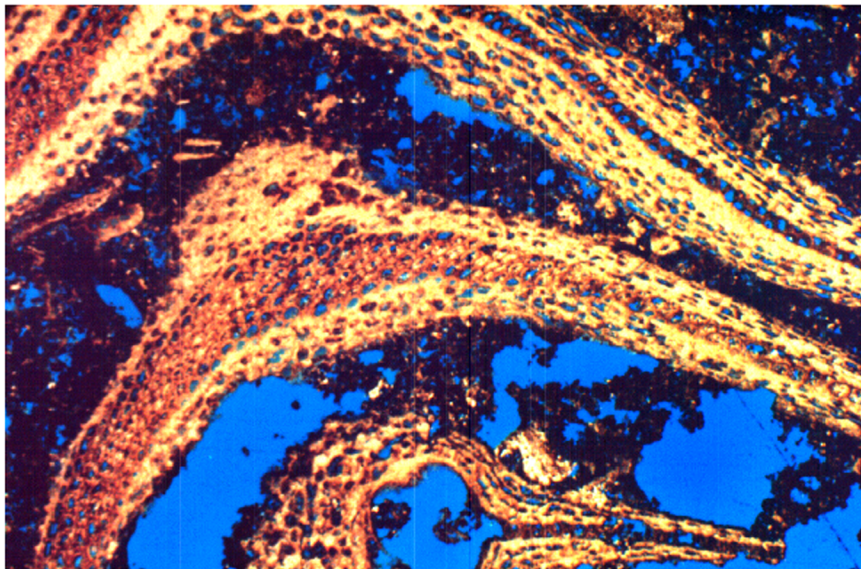

WELL: L2-PW
DEPTH: 836.9
MAGNIFICATION: X40

LITHOFACIES: PHOTOMICROGRAPH OF CLOSE UP OF LEPIDOCYCLINA
PELOIDAL BAFFLESTONE SHOWING INTRAPARTICLE AND SHELTER POROSITY

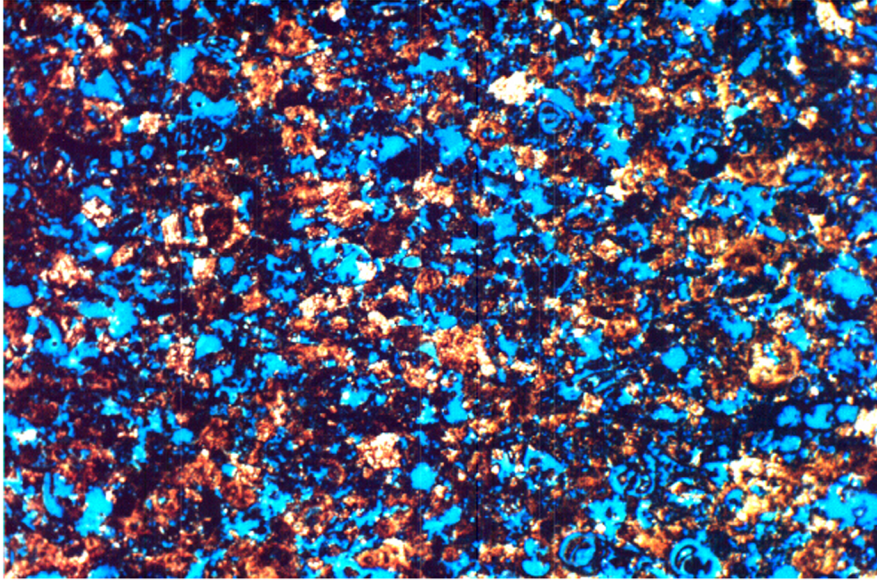

WELL: L2-PW
DEPTH: 1020.5
MAGNIFICATION: X40

LITHOFACIES: PHOTOMICROGRAPH OF VERY POROUS VUGGY MOLDIC INTERPARTICLE LAMINAE IN NUMMULITES-FORAM PELOIDAL WACKESTONE-PACKSTONE; SOME SCATTERED, ISOLATED FINE CRYSTALLINE DOLOMITE CRYSTALS.

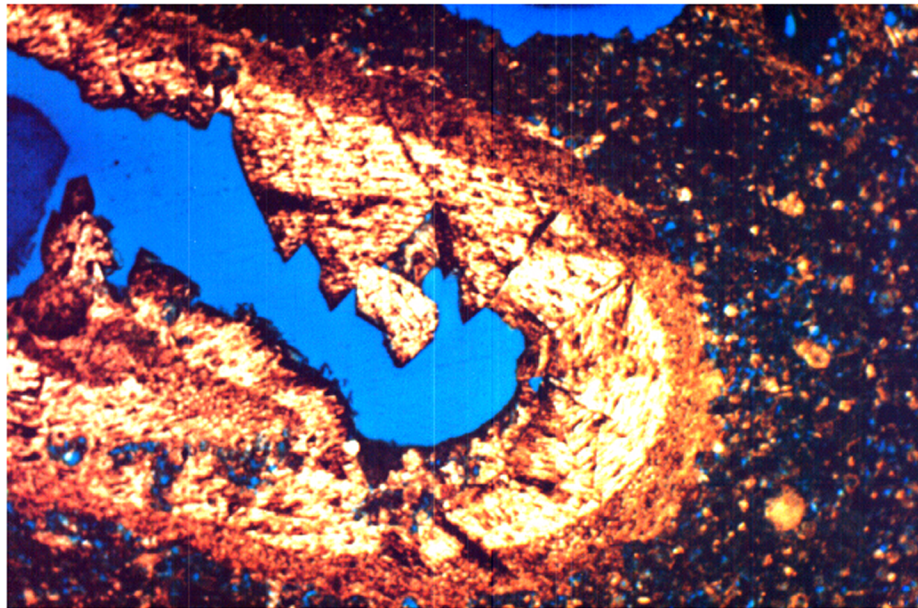

WELL: L2-PW
DEPTH: 1022.6
MAGNIFICATION: X40

LITHOFACIES: PHOTOMICROGRAPH OF LEACHED AND PARTLY OCCLUDED AND PARTLY INFILLED NUMMULITES MOLD. VERY COARSE CALCITE CRYSTAL IS THE CEMENT.

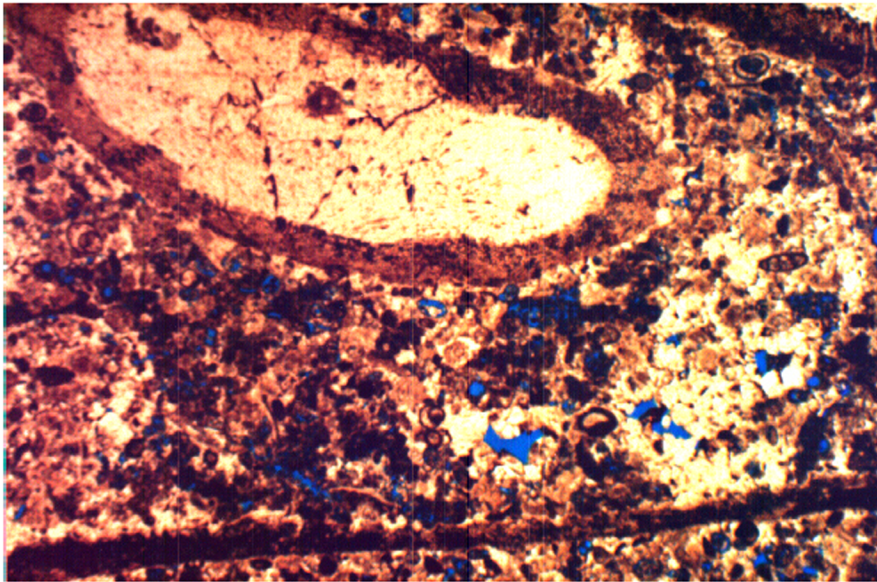

WELL: L2-PW
DEPTH: 1027.7
MAGNIFICATION: X20

LITHOFACIES: PHOTOMICROGRAPH OF WELL CEMENTED NUMMULITES WACKESTONE-GRAINSTONE WITH CALCITE OCCLUSION. NUMMULITES WALL POROSITY IS POOR INTERCRYSTALLINE, VUG, AND INTRAPARTICLE.

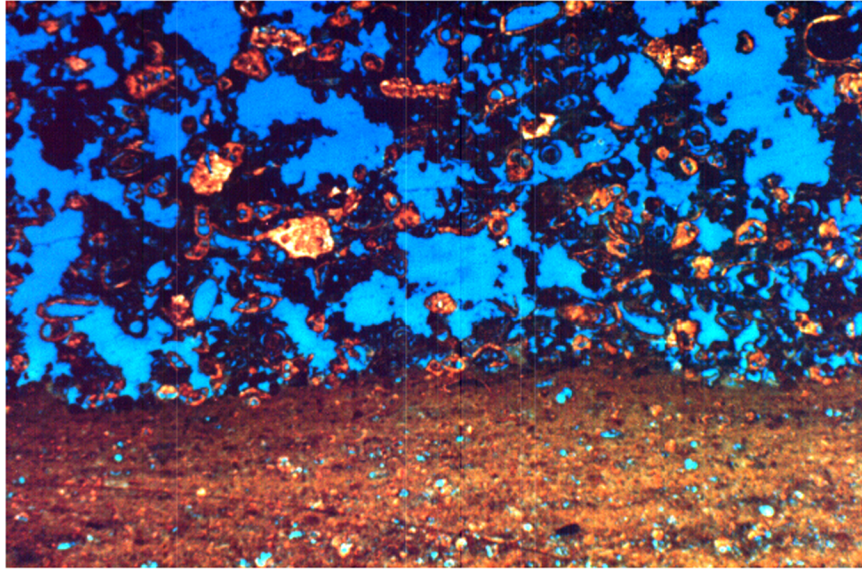

WELL: L2-PW
DEPTH: 1191.1
MAGNIFICATION: X20

LITHOFACIES: PHOTOMICROGRAPH OF INTERLAMINATED VERY POROUS PELOIDAL-FORAM PACKSTONE WITH ARGILLACEOUS LAMINAE. THE POROSITY IN THE TIGHTER LAMINAE IS MOLDIC MICROPOROSITY AND VUGGY INTERPARTICLE IN THE POROUS LAMINAE.

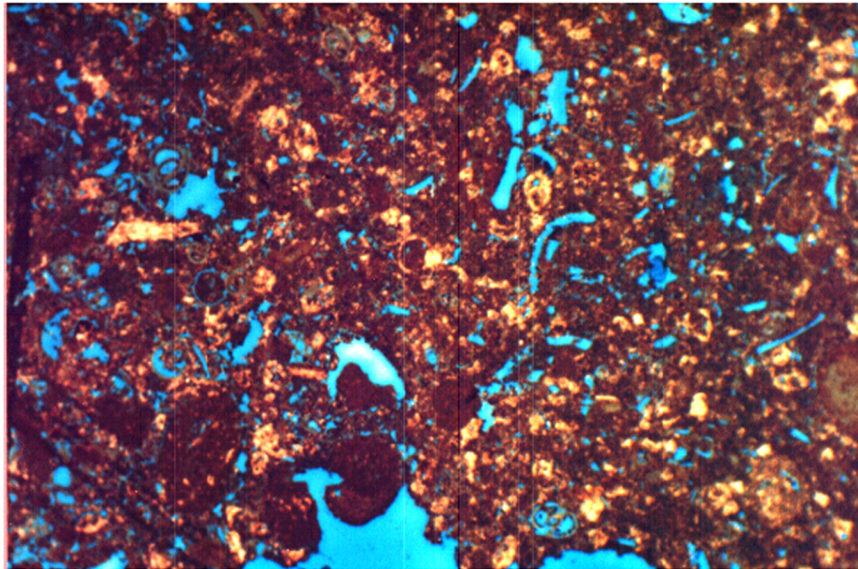

WELL: L2-PW
DEPTH: 1191.7
MAGNIFICATION: X40

LITHOFACIES: PHOTOMICROGRAPH OF PELOIDAL-FORAM WACKESTONE
WITH FAIR MOLDIC, INTRAPARTICLE, AND VUGGY POROSITY

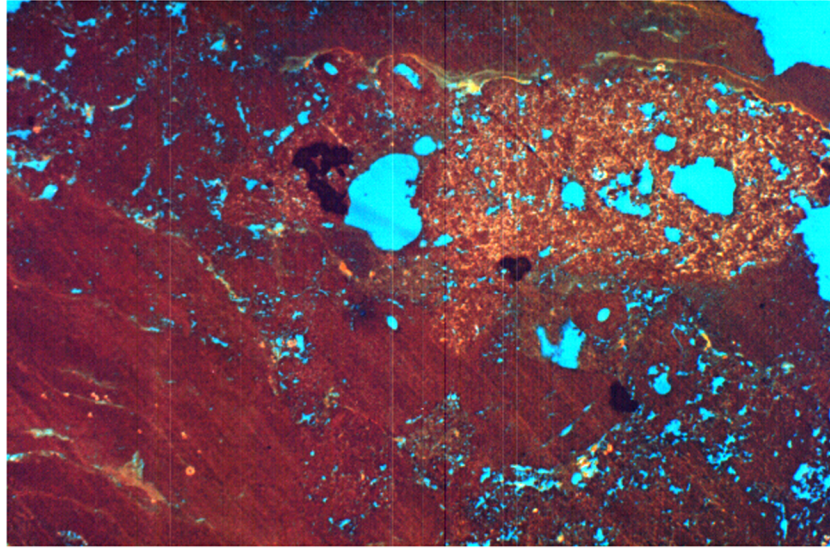

WELL: L2-PW
DEPTH: 1194.3
MAGNIFICATION: X20

LITHOFACIES: PHOTOMICROGRAPH OF BISCUIT-LIKE ALGAL LAMINATIONS WITH INTERLAMINATED PELOIDAL PACKSTONE, NOTE: INCLINED LAMINATIONS AND WEDGING OF PELOIDAL PACKSTONE. FAIR VUGGY MOLDIC POROSITY IS PRESENT.

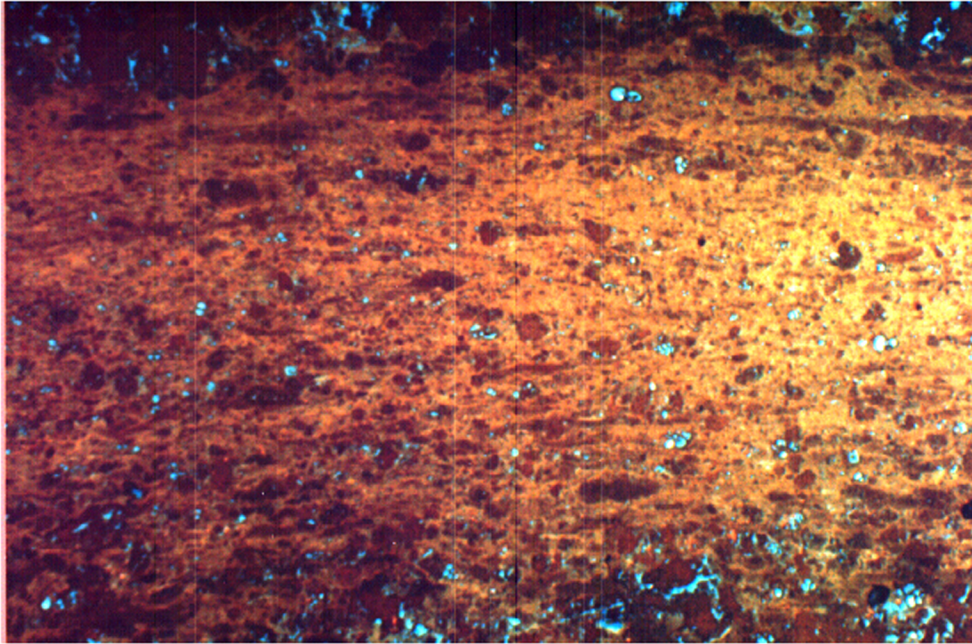

WELL: L2-PW
DEPTH: 1195.7
MAGNIFICATION: X20

LITHOFACIES: PHOTOMICROGRAPH OF MICROPOROSITY IN THIN LAMINATIONS BETWEEN PELOIDAL PACKSTONES

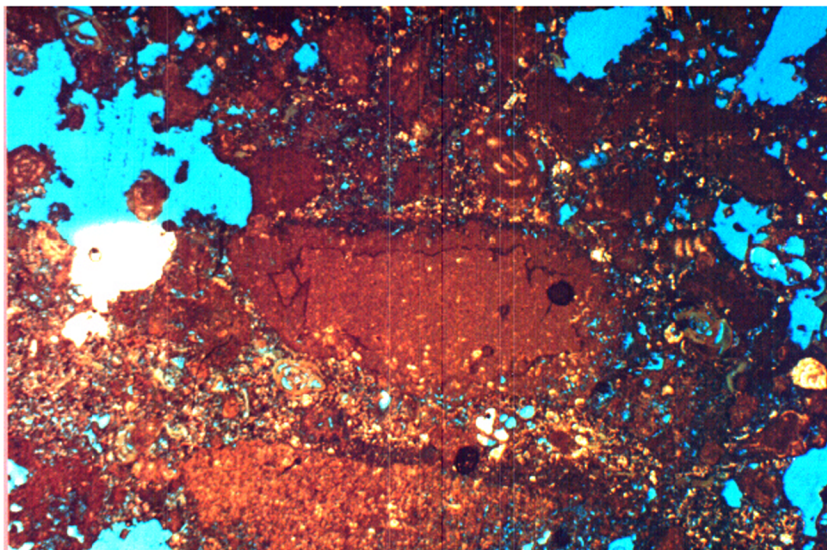

WELL: L2-PW
DEPTH: 1331.5
MAGNIFICATION: X20

LITHOFACIES: PHOTOMICROGRAPH OF PELOIDAL-FORAM-INTRACLASTIC
PACKSTONE WITH FAIR VUGGY POROSITY

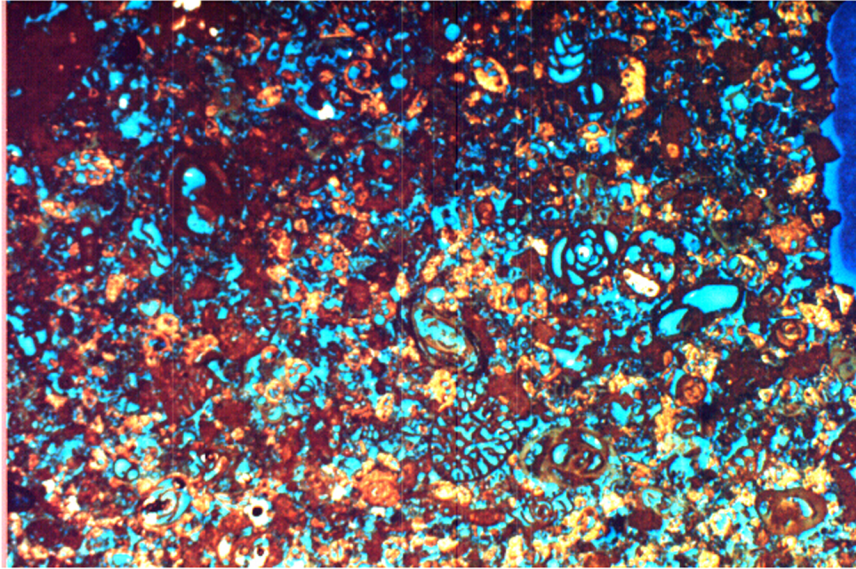

WELL: L2-PW
DEPTH: 1333
MAGNIFICATION: X20

LITHOFACIES: PHOTOMICROGRAPH OF PELOIDAL-FORAM PACKSTONE WITH GOOD INTERPARTICLE, VUGGY, AND FORAM INTRAPARTICLE POROSITY

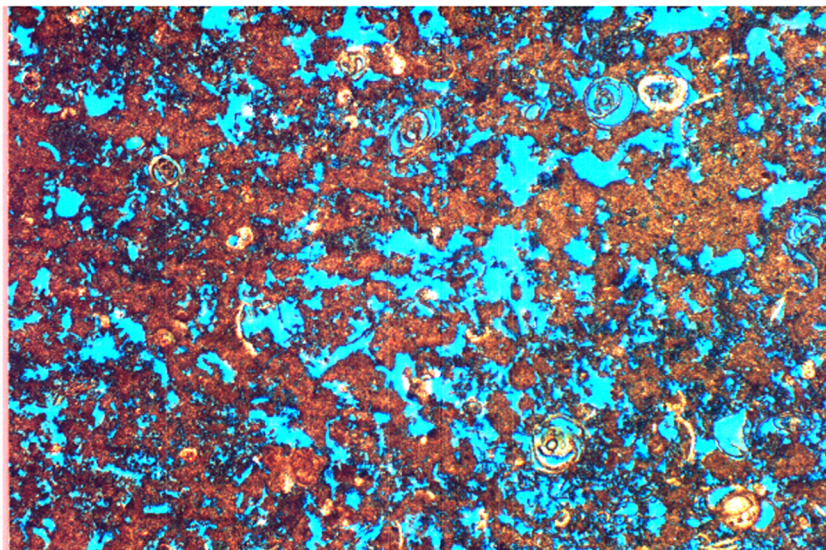

WELL: L2-PW
DEPTH: 1480.6
MAGNIFICATION: X40

LITHOFACIES: FORAM-PELOIDAL PACKSTONE WITH GOOD VUGGY INTERPARTICLE, POROSITY AND FAIR FORAM INTRAPARTICLE POROSITY

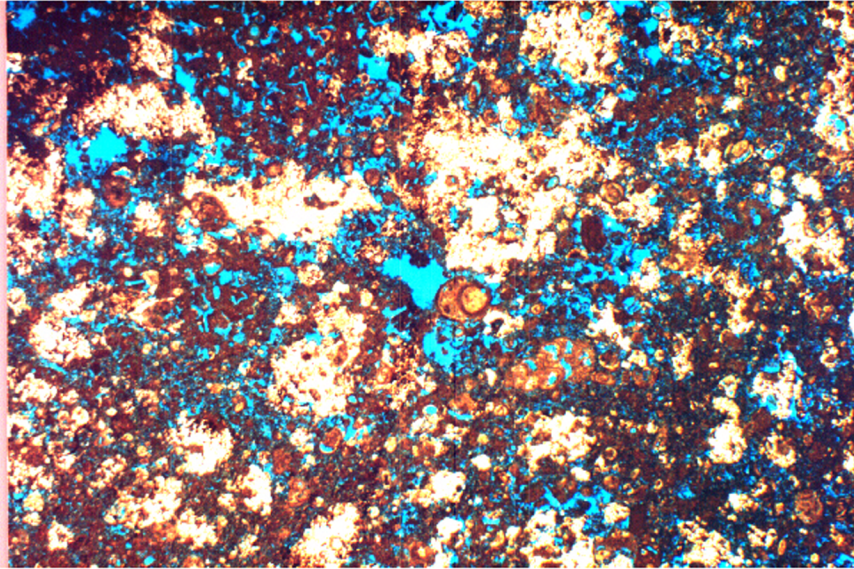

WELL: L2-PW
DEPTH: 1483
MAGNIFICATION: X

LITHOFACIES: PHOTOMICROGRAPH OF FORAM-PELOIDAL PACKSTONE
WITH GOOD VUGGY INTERPARTICLE POROSITY PARTIALLY RECRYSTALLIZED
AND OCCLUDED BY PATCHY BLOCKY CALCITE CEMENT

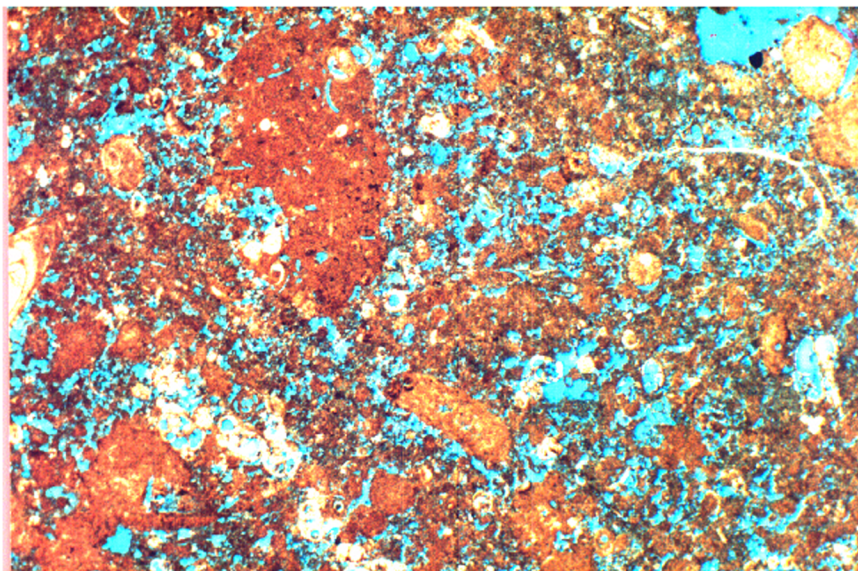

WELL: L2-PW
DEPTH: 1483.7
MAGNIFICATION: X20

LITHOFACIES: PHOTOMICROGRAPH OF FORAM-INTRACLASTIC-PELOIDAL
PACKSTONE WITH GOOD INTERPARTICLE VUGGY POROSITY

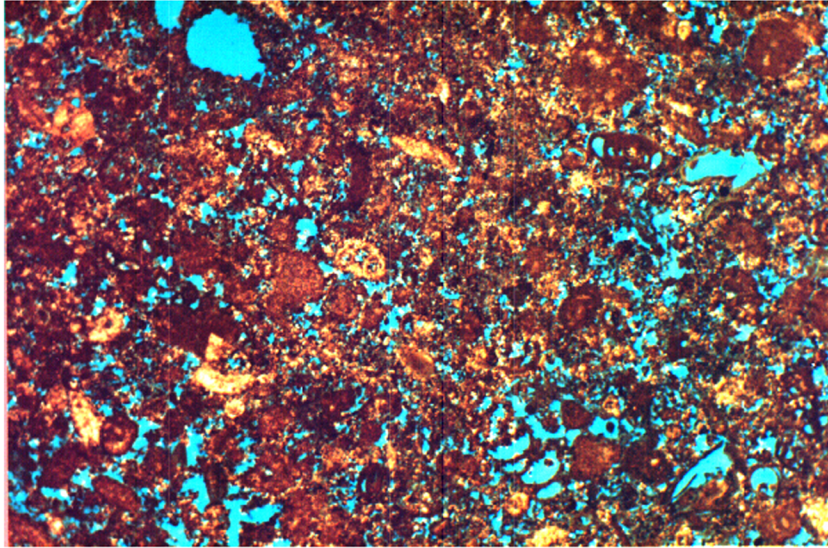

WELL: L2-PW
DEPTH: 1580
MAGNIFICATION: X20

LITHOFACIES: PHOTOMICROGRAPH OF INTRACLASTIC FORAM PELOIDAL
PACKSTONE WITH GOOD VUGGY INTERPARTICLE POROSITY

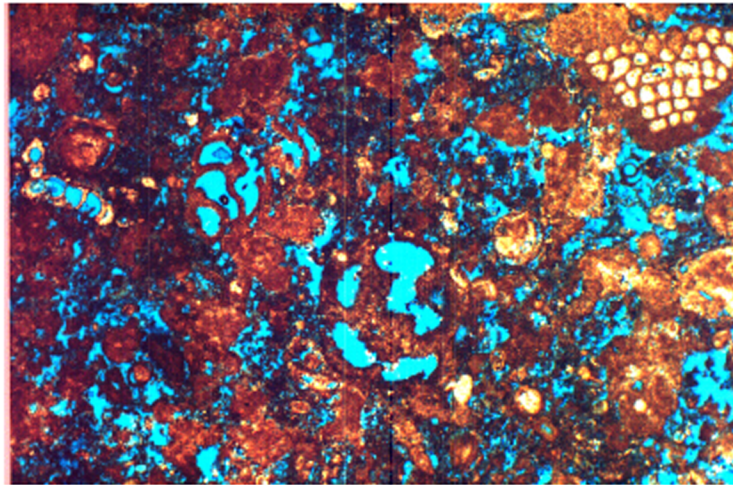

WELL: L2-PW
DEPTH: 1631.1
MAGNIFICATION: X20

LITHOFACIES: PHOTOMICROGRAPH OF FORAM PELOIDAL PACKSTONE
WITH FAIR VUGGY MOLDIC POROSITY AND FAIR FORAM INTRAPARTICLE AND
INTERPARTICLE POROSITY

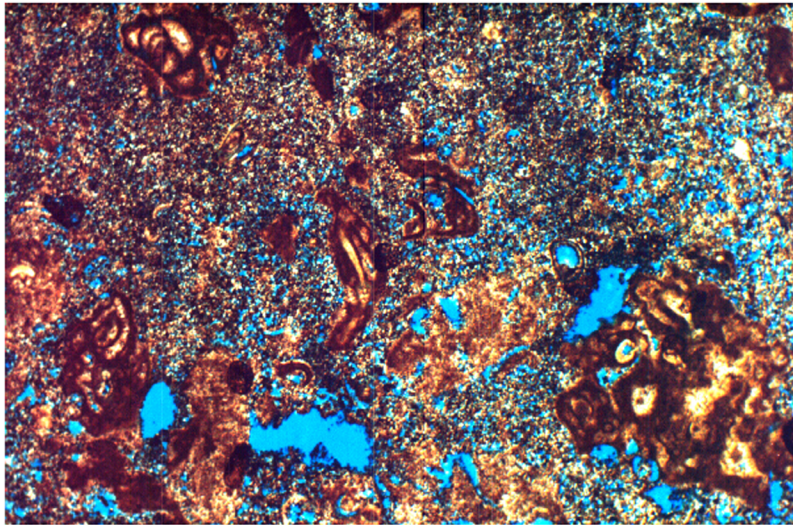

WELL: L2-PW
DEPTH: 1633.3
MAGNIFICATION: X20

LITHOFACIES: PHOTOMICROGRAPH OF RECRYSTALLIZED FORAM-PELOIDAL WACKESTONE WITH SCATTERED VUG AND ABUNDANT MICRO-POROSITY

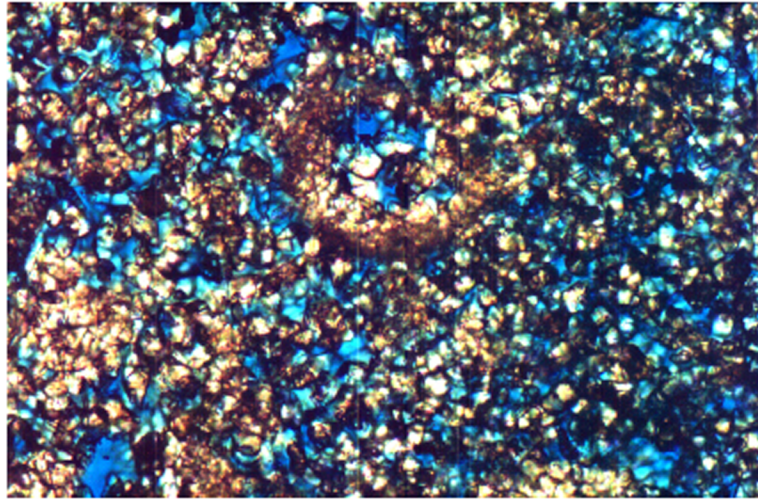

WELL: L2-PW

DEPTH: 1633.3

MAGNIFICATION: X400

LITHOFACIES: CLOSE UP PHOTOMICROGRAPH OF MICROPOROSITY
SHOWING RECRYSTALLINE NATURE

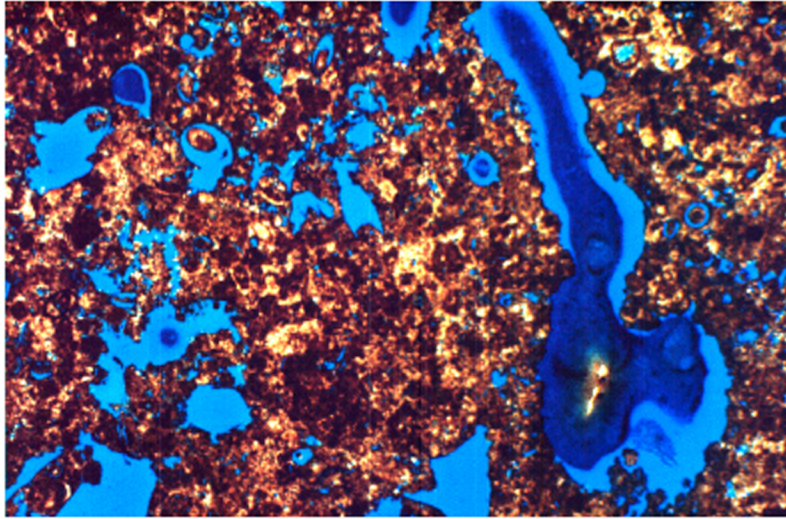

WELL: L2-PW
DEPTH: 1710.6
MAGNIFICATION: X20

LITHOFACIES: PHOTOMICROGRAPH OF FORAM-PELOIDAL PACKSTONE
WITH GOOD VUGGY MOLDIC POROSITY AND POSSIBLE CHANNEL POROSITY

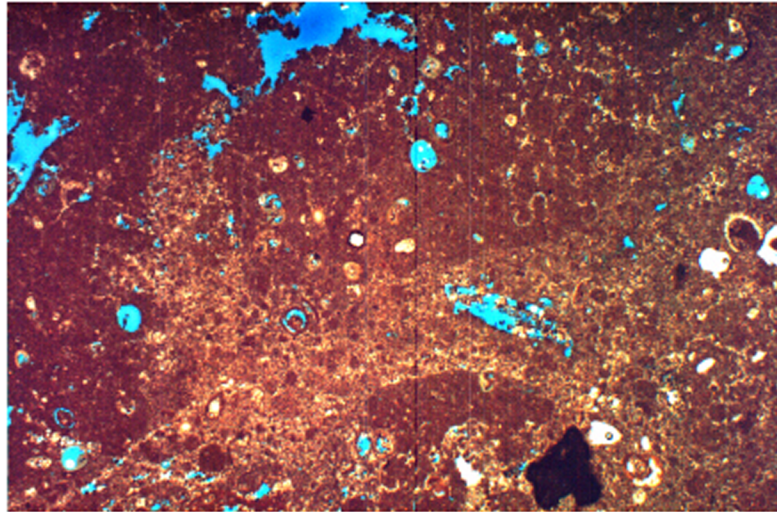

WELL: L2-PW
DEPTH: 1711.3
MAGNIFICATION: X20

LITHOFACIES: PHOTOMICROGRAPH OF FORAM-PELOIDAL INTRACLASTIC PACKSTONE WITH FAIR YUGGY MOLDIC POROSITY AND SCATTERED LARGER VUGS. INTRACLASTS ARE DUE TO BURROWING.

