

STRUCTURAL IMPROVEMENTS

1960-61 Improvements

Between July 1, 1960, and September 30, 1961, contracts were let for several structural improvements to City facilities and for the construction of new facilities. The total cost of these improvements was \$672,000, with the new Central Fire Station accounting for the bulk of this. These improvements are as follows:

| | |
|---|-----------|
| Central Fire Station | \$500,000 |
| Repainting Miami Stadium | 53,300 |
| Shenandoah Library Addition | 24,000 |
| Site for Lemon City Library | 35,000 |
| Torch of Friendship | 18,000 |
| Apparatus Room at Fire College | 6,000 |
| Miscellaneous Structural Improvements to Orange Bowl, Miami Stadium, Watson Building, etc. | 35,700 |

1961-62 Proposed Improvements

Scheduled for 1961-62 are \$440,000 in structural improvements. Notable among these are: a new Lemon City Branch Library, a body and fender shop at the Motor Pool, and a new Fire Division maintenance shop. A brief listing of these improvements follows.

| | |
|--|-----------|
| Lemon City Library | \$102,000 |
| Fire Division Maintenance Shop | 130,000 |
| Motor Pool Body and Fender Shop | 88,000 |
| New Roof for Dinner Key Auditorium | 56,000 |
| Fire Division Improvements (2 reserve apparatus rooms) | 30,000 |
| Orange Bowl Improvements | 27,000 |
| Communication Division Improvements | 7,000 |

STRUCTURAL IMPROVEMENTS

1960-61 IMPROVEMENTS \$ 672,000

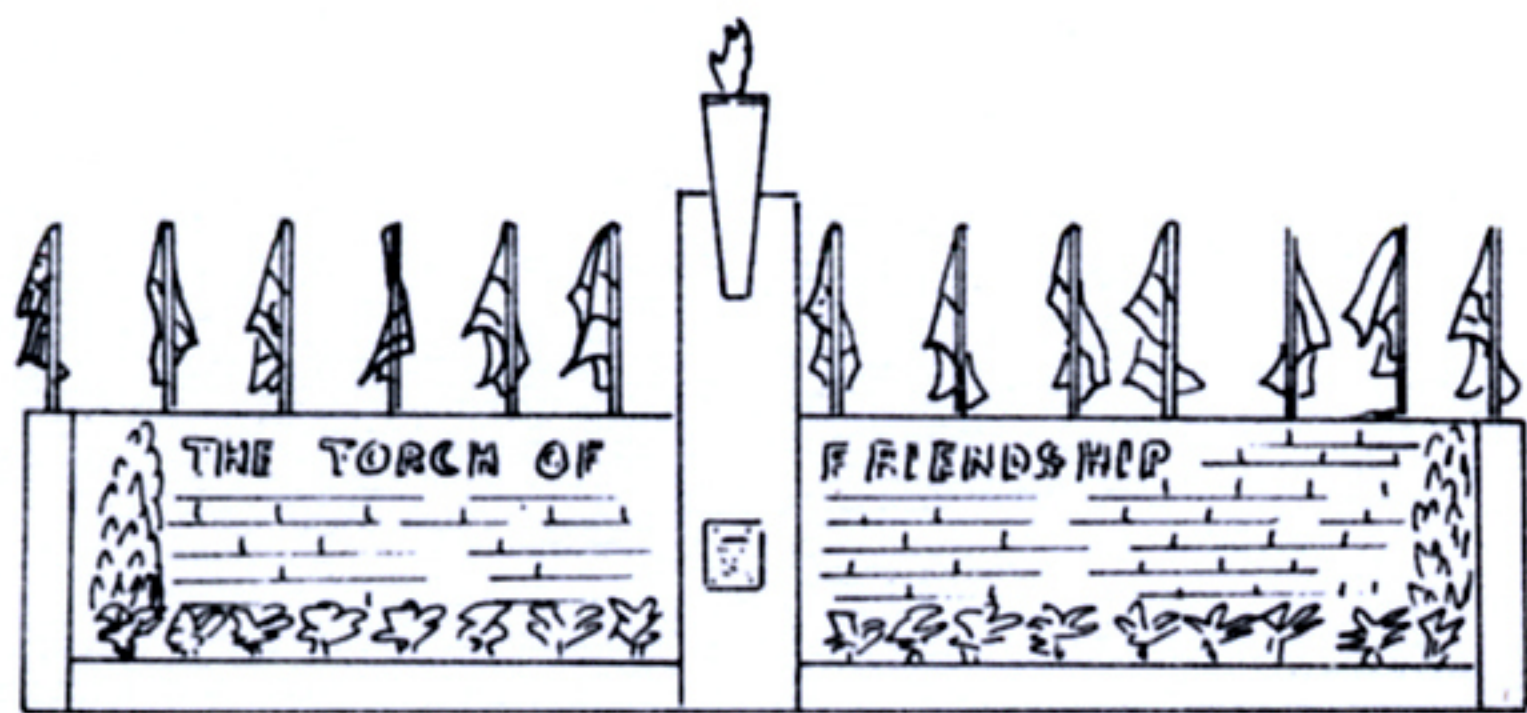

TORCH OF FRIENDSHIP

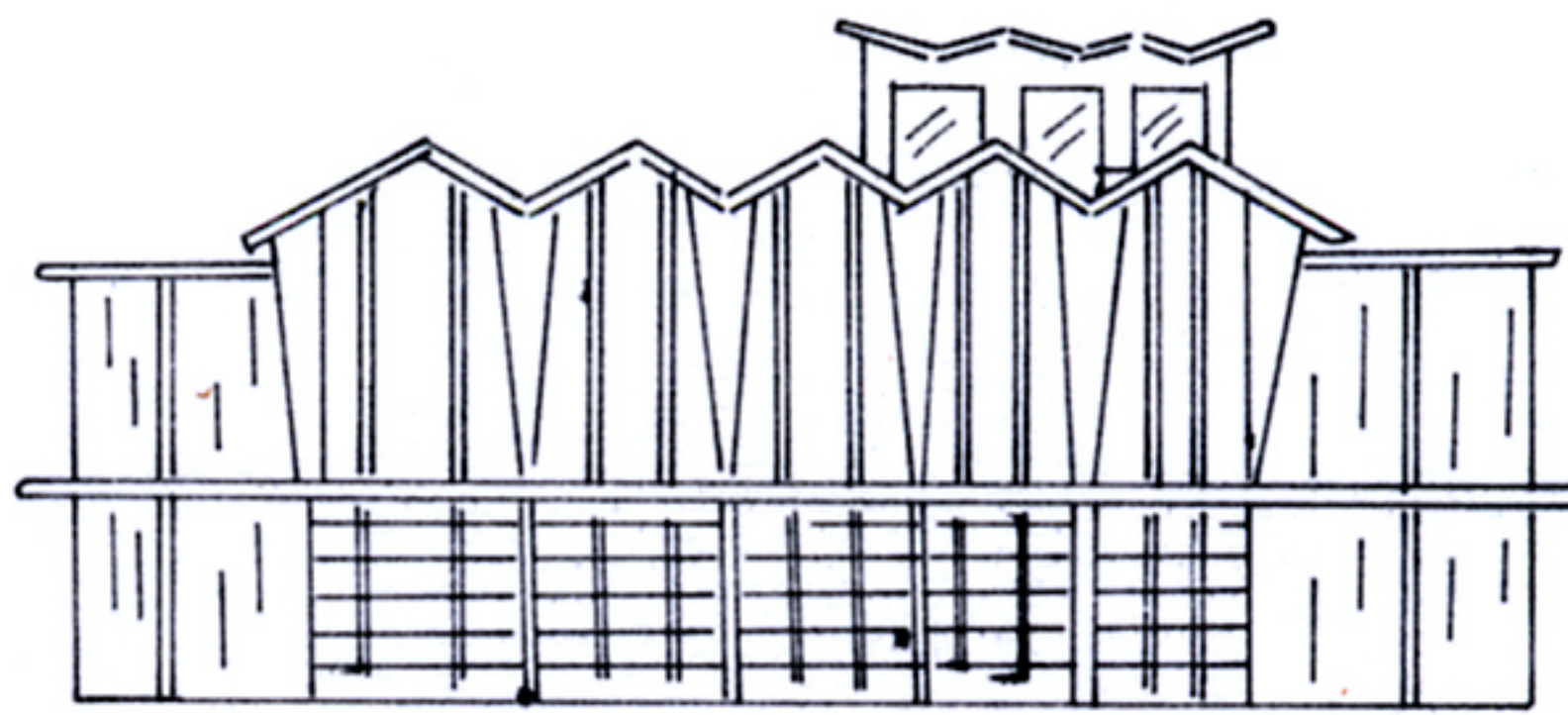

CENTRAL FIRE STATION

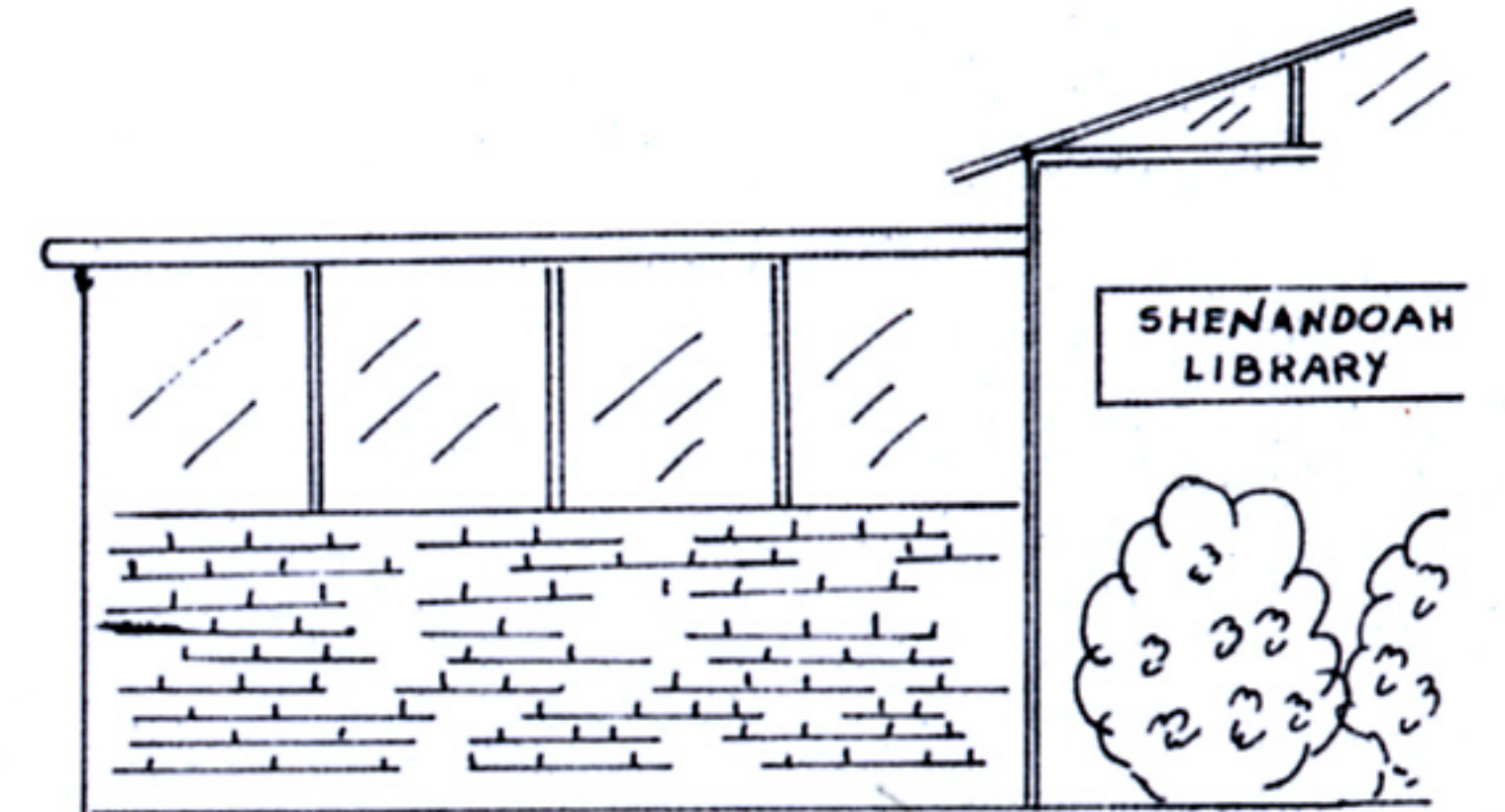

SHENANDOAH LIBRARY ADDN.

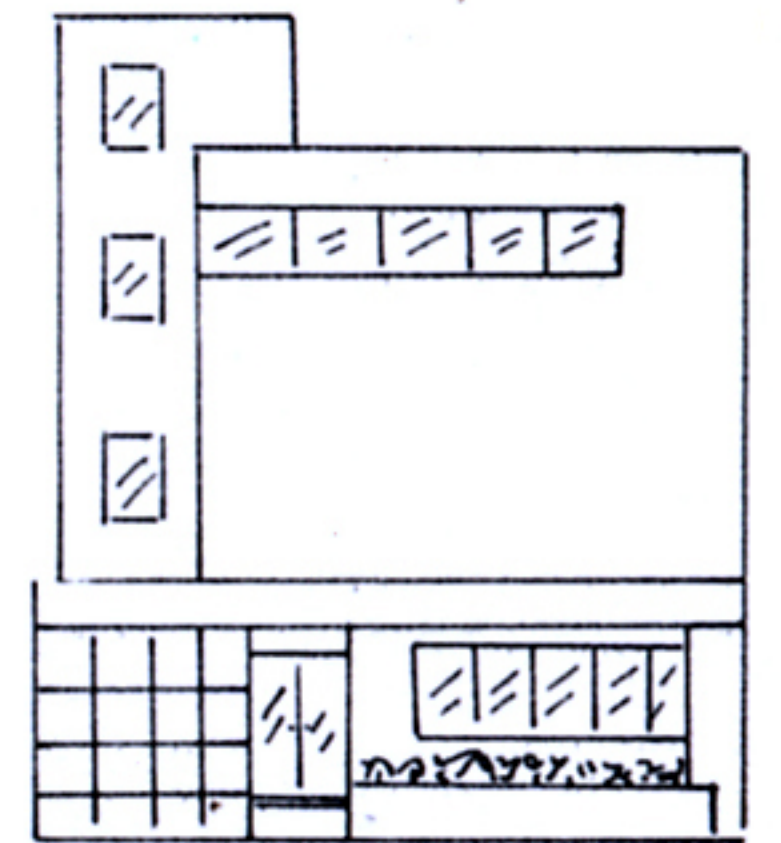
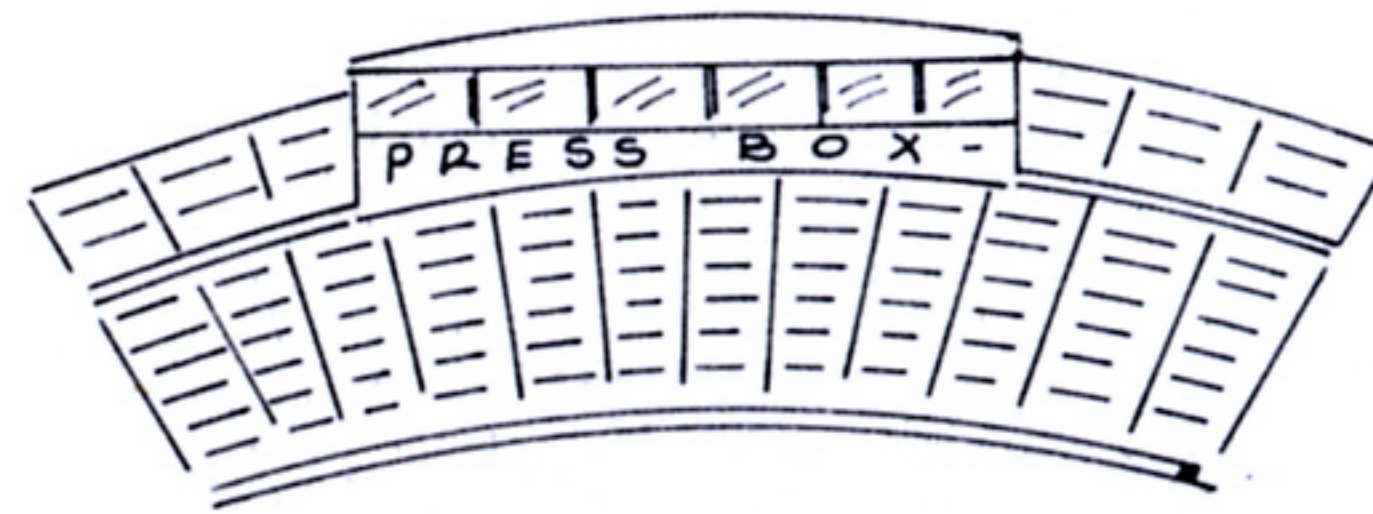
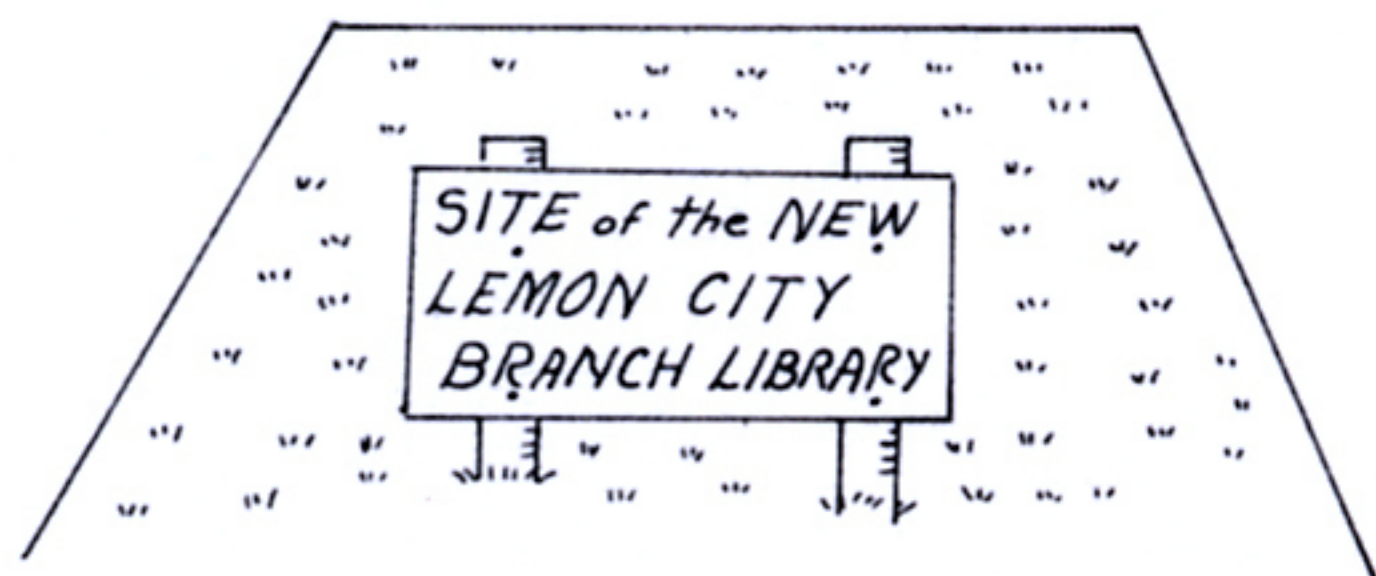
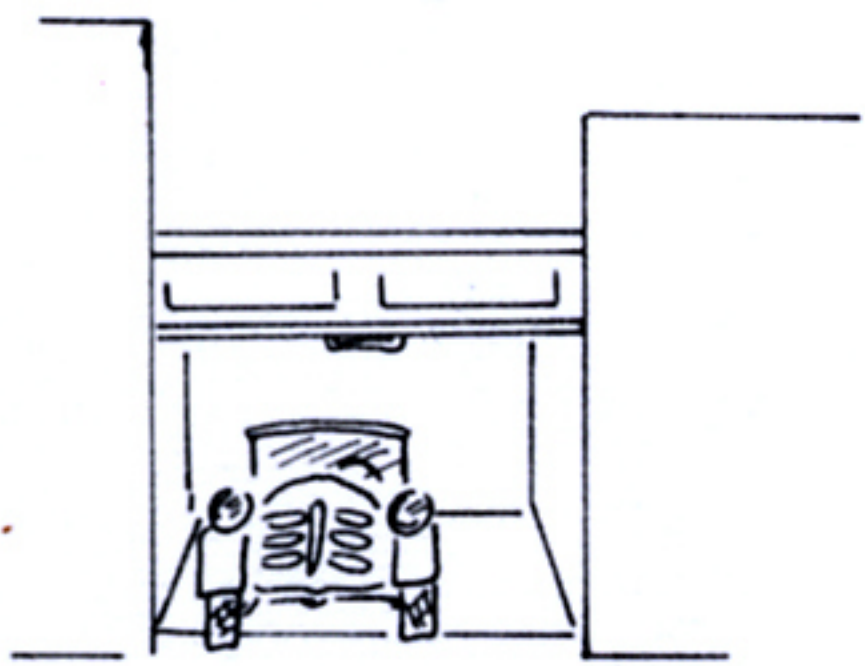

MISCELLANEOUS IMPROVEMENTS TO CITY BUILDINGS

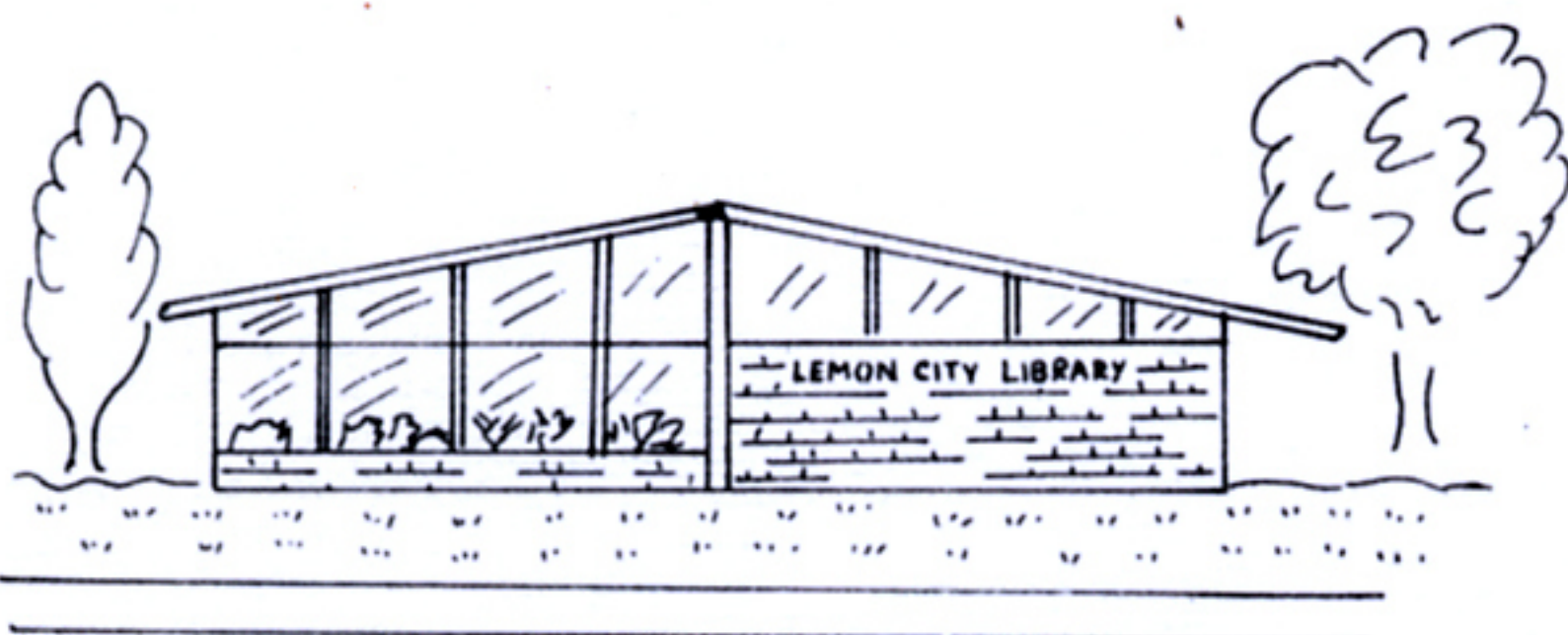

LEMON CITY LIBRARY

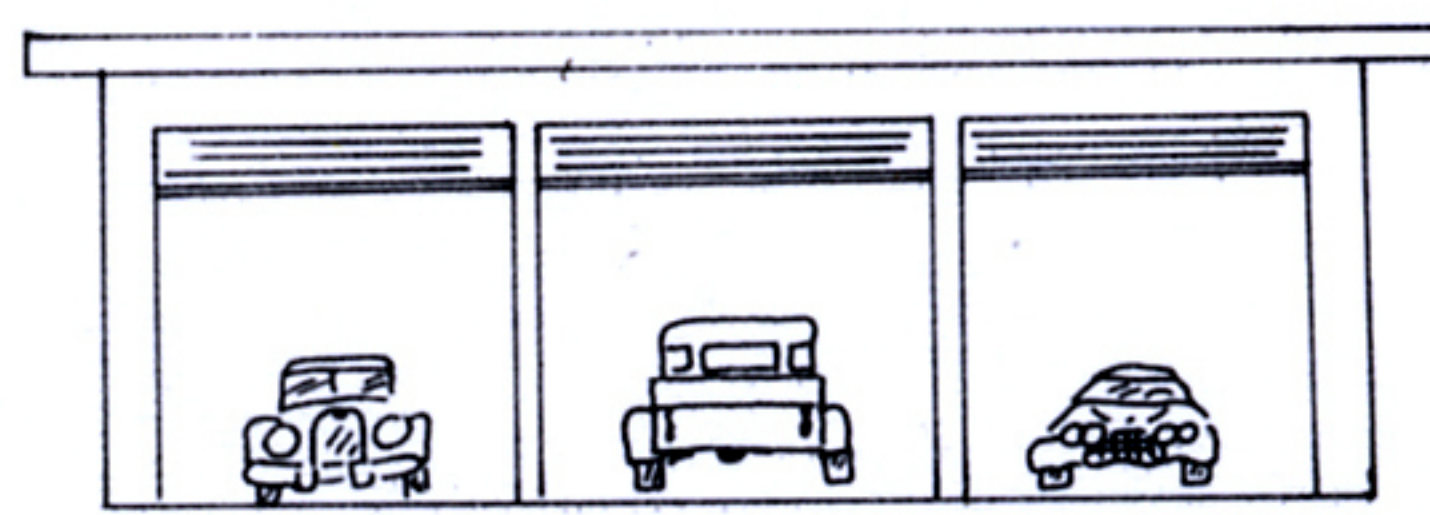

MOTOR POOL BODY AND FENDER SHOP

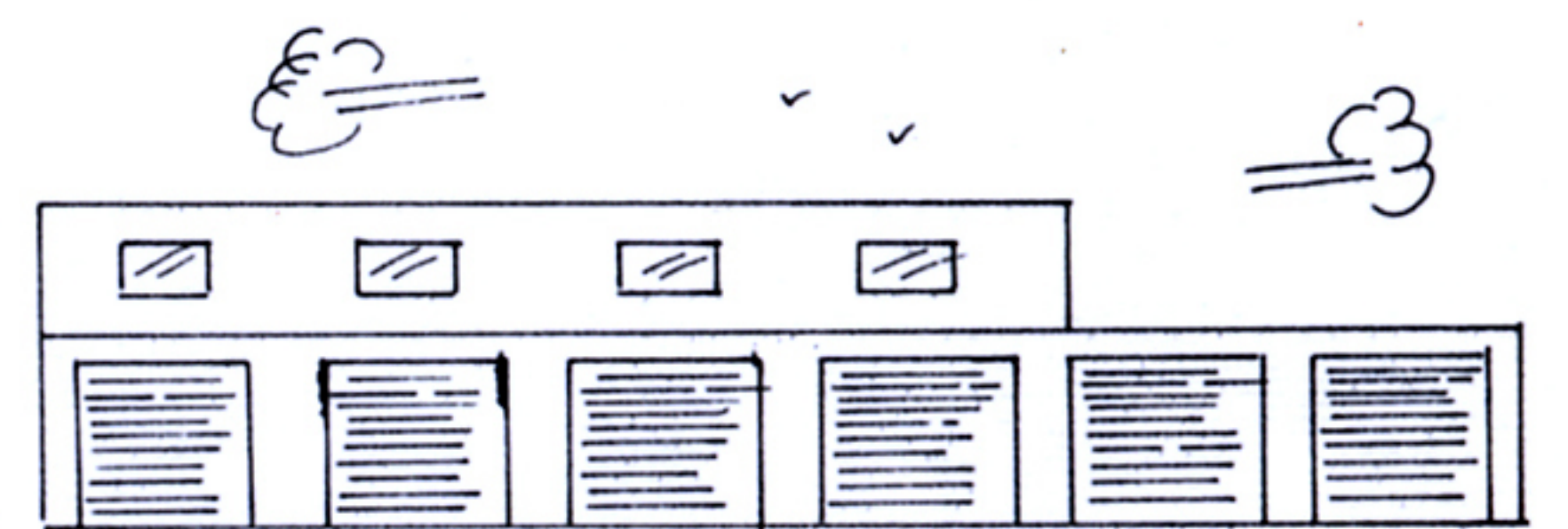

FIRE MAINTENANCE BUILDING

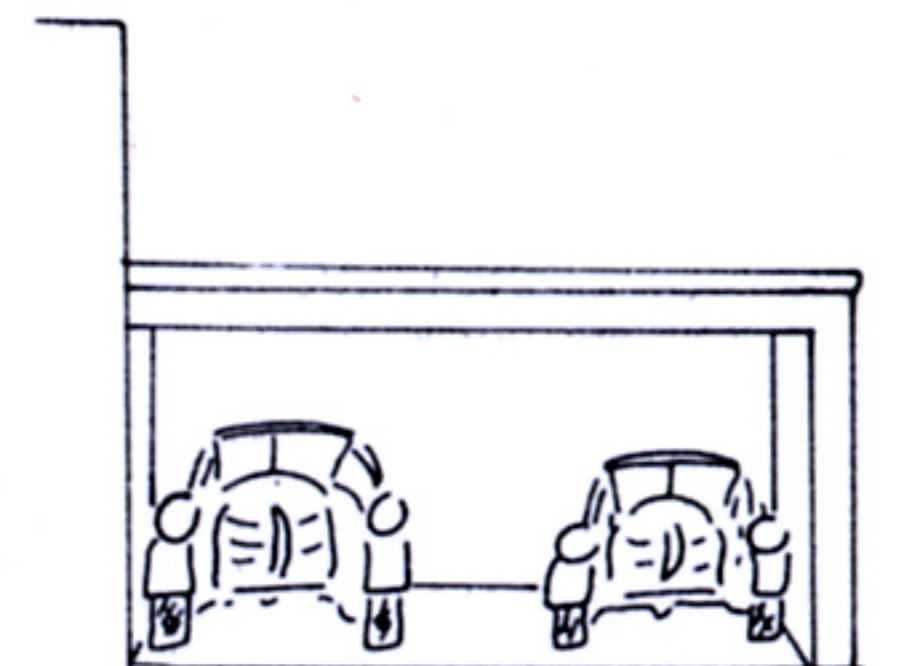
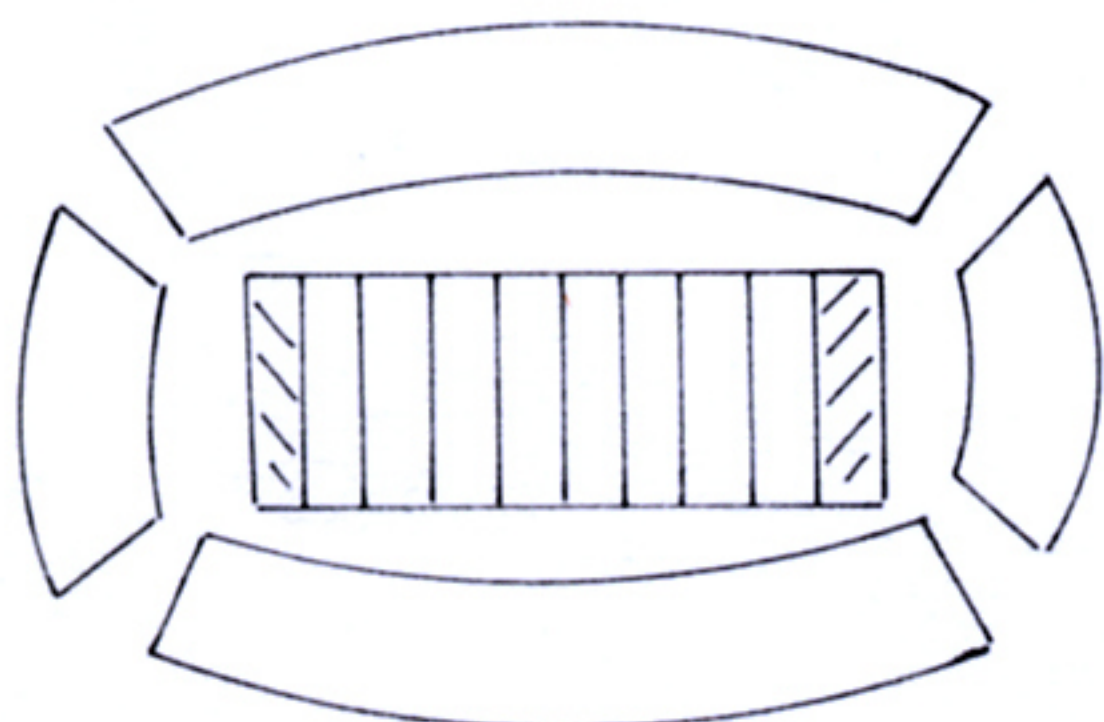

MISCELLANEOUS IMPROVEMENTS TO CITY BUILDINGS

1961-62 PROPOSED IMPROVEMENTS \$ 440,000